

# BRISTAN

## Installation Instructions and User Guide

Bristan Electric Shower

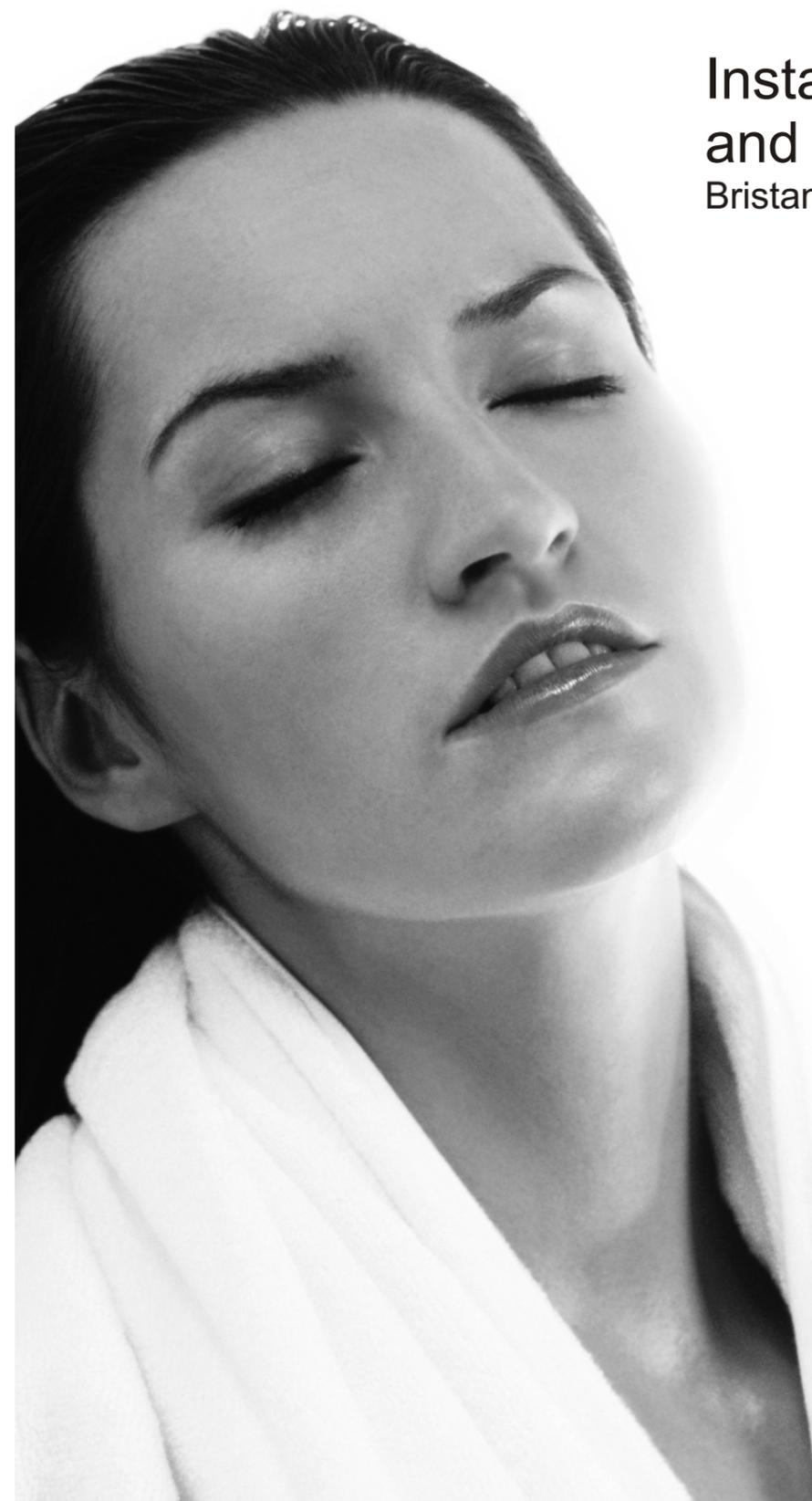

Address: Bristan Limited  
Birch Coppice Business Park  
Dordon  
Tamworth  
Staffordshire  
B78 1SG  
Web: [www.bristan.com](http://www.bristan.com)  
Tel: 0844 7016273  
Fax: 0844 7016275  
Email: [enquire@bristan.com](mailto:enquire@bristan.com)

Manufactured by:

AJ Gummers  
Unit H  
Redfern Park Way  
Tyseley  
Birmingham  
B11 2DN

A Masco Company



Please keep this booklet for future reference.

Installer, when you have read these instructions please ensure you leave them with the user.

404-0158C

# Contents

Important safety information .....	3...
Product features .....	4.....
Electrical requirements.....	5-6..
Water requirements .....	7.....
Plumbing connections.....	8.....
Electrical connections .....	9.....
Fixing your shower to the wall.....	10..
Fitting the riser rail.....	10...
Commissioning - testing the system.....	11..
Operating the shower .....	12...
Adjusting the showerhead.....	12...
Cleaning & maintenance.....	12...
Troubleshooting .....	13.....
Spare parts.....	14.....
Guarantee .....	15.....
Service policy .....	15.....

# Guarantee

## Guarantee

Thank you for purchasing a Bristan product. This product has been designed, manufactured and tested, in the UK; to the highest standards.

Guarantee: 2 years.

This guarantee applies to products purchased within the United Kingdom or Republic of Ireland, but does not apply to products used commercially.

This is provided that:

1. The guarantee registration card is completed and returned within ten days complete with a copy of proof and purchase. Proof of purchase is required for any serviced requirements.

2. The product is installed and operated in accordance with our instructions and has not been misused or damaged.

This in no way affects your statutory rights as a consumer.

The information on the Guarantee card helps Bristan to process any claims and contact you about your product and its maintenance if required. The registration of your personal details is purely for Bristan use and the remaining information helps us to make products for the future.

Should a complaint arise, products are guaranteed against faulty workmanship and materials for a period of 12 months from the date of purchase, when in domestic use (second year guarantee is parts only). For your guarantee to be valid, your shower must be installed by a competent person, in accordance with the installation manual.

Bristan will repair or replace (at our option), free of charge, any faulty components during the guarantee period, provided it has been maintained and operated in accordance with our instructions, and has not been misused or damaged.

Modification or repair of this product by person (s) not authorised by Bristan will invalidate this guarantee.

This guarantee does not effect your statutory rights.

## Service Policy Replacement Parts Policy

### IMPORTANT

In the event of product or component malfunction, DO NOT tamper with or remove the product from site. Telephone the Customer Services Department on 0844 7016273 and be prepared with the date of purchase, model number and a clear description of the complaint.

Our service staff are fully qualified to advise on correct installation procedures and will be able to diagnose whether the fault will require a replacement part or a visit from a Bristan engineer.

If required, a service call will be booked and either yourself or an appointed representative (who should be a person of 18 years or over) must be present during the visit.

All site visits to product within the guarantee period will be carried out free of any parts or labour charges provided the conditions of the guarantee have been adhered to (the second year guarantee is parts only).

All site visits to product out of guarantee will be subject to charges for parts and labour which is payable by you or your appointed representative at the time of the visit. Charges will also be levied on cancelled appointments, unless advised to Bristan at least 24 hours in advance of the agreed date and time.

We reserve the right not to undertake work where payment cannot be made to our engineer at the time of the visit.

Bristan hold stocks of components for all their range of products and these will be maintained for the duration of their life.

Should a product be discontinued, spare parts stocks will be maintained, but in the event of a part becoming unavailable Bristan reserve the right to supply a substitute of equal quality.

The following payment methods can be used to obtain spare parts:

By post, pre-payment of proforma invoice by cheque or postal order.

By telephone quoting credit card (MasterCard, Visa or Visa Delta) details.

Customer Service Hotline:

**Tel: 0844 7016273 • Fax: 0844 7016275**

# Spare Parts

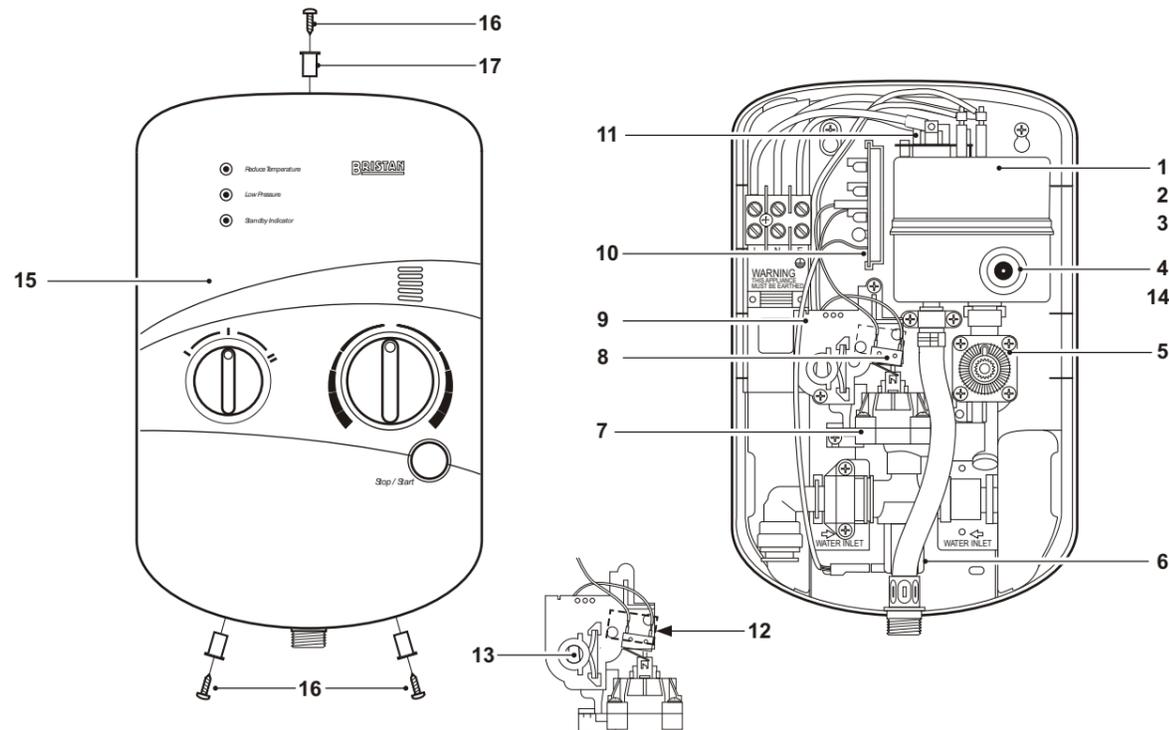

No.	Part No.	Description	85	95	104
01	SP-092-0546	8.5kW Heating Canister	X		
02	SP-092-0547	9.5kW Heating Canister		X	
03	SP-092-0548	10.34kW Heating Canister			X
04	SP-092-0425	PRD Cap & Shear Pad	X	X	X
05	SP-092-1042	Stabiliser Valve (High Flow)	X	X	X
06	SP-092-0426	Solenoid	X	X	X
07	SP-092-0291	Pressure Switch Assembly	X	X	X
08	SP-092-1050	Low Pressure Microswitch with Lever	X	X	X
09	SP-092-1025	Camshaft Retention Plate	X	X	X
10	SP-092-0420	Phased Shutdown PCB	X	X	X
11	SP-092-1133	2 Stage Thermal Cut-out	X	X	X
12	SP-092-1077	Microswitch - 25 amp	X	X	X
13	SP-092-0355	Camshaft	X	X	X
14	SP-092-1060	Pressure Relief Device Assembly	X	X	X
15	SP-Cover**/**	Cover & Knob Assembly	X	X	X
16	SP-092-0018	Cover Retaining Screw	X	X	X
17	SP-092-0429	Screw Bush	X	X	X
	SP-BR-5020	B85 Base Assembly Complete	X		
	SP-BR-5021	B95 Base Assembly Complete		X	
	SP-BR-5022	B104 Base Assembly Complete			X
	SP-285-0820	1.50 x 8mm Shower Hose	X	X	X
	SP-168-0205	Handset	X	X	X
	SP-320-0026	Hose Washer	X	X	X

\*Please state model of shower \*\*Please state colour

# Important Safety Information

- Please read these instructions thoroughly and retain for future use.
- All products manufactured and supplied by Bristan are safe provided they are installed, used correctly and receive regular maintenance in accordance with these instructions.
- **If you are in any doubt what so ever about your ability to install this product safely you must employ the services of an experienced qualified plumber.**
- **Warning:** Do not operate the shower unit if you suspect it is frozen. Do not site the shower unit where it might be subjected to freezing conditions.
- Do not operate the shower unit if the showerhead or spray hose has been damaged or is blocked.
- Do not block the flow of water from the showerhead, by placing it (smothering it) on your hand or any other part of your body or foreign object.
- Do not operate the shower if the water stops flowing during use or if the water is leaking from the shower unit itself.

## General Safety

- Always switch off the power at the consumer unit and remove the correct circuit fuse before making any electrical connections or if you have to remove the cover of an installed unit.
- The unit must be mounted on the finished wall surface (usually tiled). Under no circumstances must you tile up to the unit after fixing it directly to the bare wall as this may cause overheating and activate the pressure relief device (PRD).
- If the shower unit is fitted in a hard water area, a scale inhibitor may have to be fitted and the filter cleaned regularly. For more advice on obtaining a scale inhibitor, contact Customer Services on 0844 7016273.



BEAB (British Electrotechnical Approvals Board) approval of safety.

# Product Features

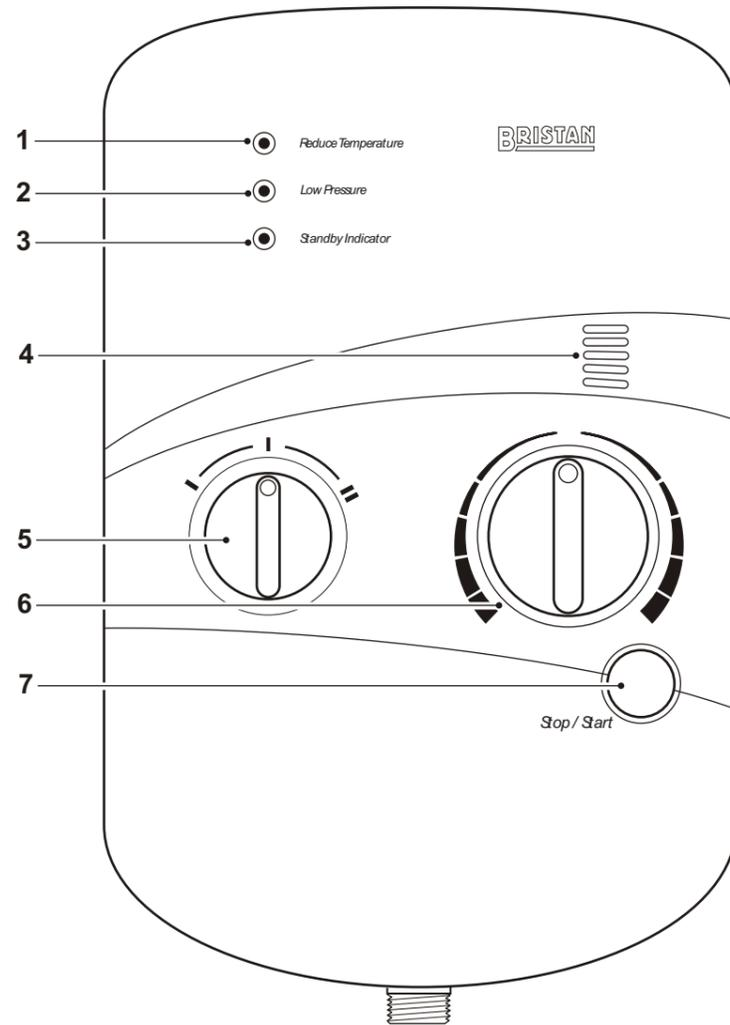

**1. Reduce Temperature Indicator**

Indicator light to show when the temperature selection is too high.

**2. Low Pressure Indicator**

Indicator light to show low incoming water pressure.

**3. Standby Indicator**

Indicator light to show the unit has power to it and is ready for operation.

**4. Location for Pressure Relief Device (PRD)**

Ventilation holes for RPD.

**5. Power Control**

Adjustable power settings: Low (Cold), Medium and High.

**6. Temperature Control**

Adjustable Temperature Control.

**7. Push Button STOP/START Switch**

Electronic Switch.

# Troubleshooting

**Warning:** Before carrying out general repairs or testing the shower, ensure that the electricity supply is turned off at the mains and the correct circuit is removed.

Symptom	Likely Cause	Action/Remedy
Standby lights not on.	Fuse Blown. Power supply interrupted.	Examine electrical supply to shower.
No water flow.	Isolating valve. Power supply not on.	Turn on.
Low pressure light on.	Water pressure has fallen below the minimum requirement.	Check running pressure. Wait until pressure increases to 1.0 bar.
Water temperature too hot.	Insufficient water flowing through the shower.	Clean the Handset. Increase the flow by adjusting the temperature control knob to a cooler setting. Reduce the power setting.
Shower runs hot and cold during use.	Water pressure is at minimum requirement.	Check running pressure. Wait until pressure increases.
Reduce temperature light comes on.	Insufficient water flowing through the shower.	Reduce temperature setting (increase flow rate). Reduce power setting.
Water from pressure relief outlet - PRD activated.	Obstruction in hose or handset.  Unit frozen.	Call Customer Services to obtain a new RPD, Install in accordance with manufacturer's instructions.

# Operating the Shower

Please ensure the commissioning procedure has been carried out. If you did not fit this shower yourself and you are about to use it for the first time, check with the installer to ensure that they have run the commissioning procedure as described on page 11.

## To start the shower

Press the STOP/START button (1).

## To stop the shower

Press the STOP/START button (1).

It is always advisable to test the water temperature with your hand before stepping under the shower. Please note that there is always a delay of a few seconds between you selecting a temperature setting and the selected water temperature starting to flow.

**Warning:** This appliance is not intended for use by persons (including) children with reduced physical, sensory or mental capabilities, or lack of experience and knowledge, unless they have been given supervision or instruction concerning use of the appliance by a person responsible for their safety.

**IMPORTANT:** Children should be supervised to ensure that they do not play with the appliance.

**IMPORTANT:** The shower unit must be switched off at the isolating switch (pull cord) when not in use.

## Adjusting the Showerhead

Your Bristan showerhead has 3 spray modes - spray, jet spray and combination. Simply rotate the spray head one way or the other to the desired spray pattern.

## Cleaning the shower head

Your Bristan showerhead has a rub-clean pad for easy cleaning. Simply rub your fingers across the rubber spray jets and turn the shower on to remove any scale or debris. You might want to repeat this procedure if the build up of scale is excessive.

## Cleaning and Maintenance

**Before attempting to clean your shower unit you must switch off the power at the isolating switch. Do not remove the cover.**

Do not use abrasive cleaners or solvents to clean this unit. The shower unit and accessories should be cleaned with a clean, soft cloth using warm water.

The hardness of the water in your area will determine how often you should clean your showerhead. Build up of scale can come quickly and in particularly hard water areas combined with constant use you may need to clean your showerhead once a week. To ensure continued performance of your electric shower the shower head needs to be regularly descaled from lime scale buildup within the shower spray plate.

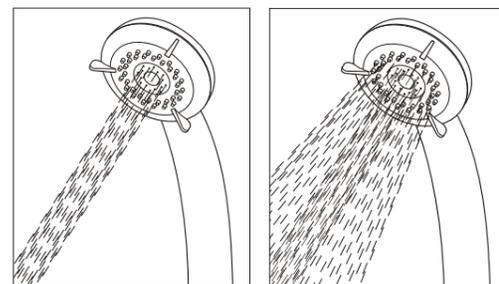
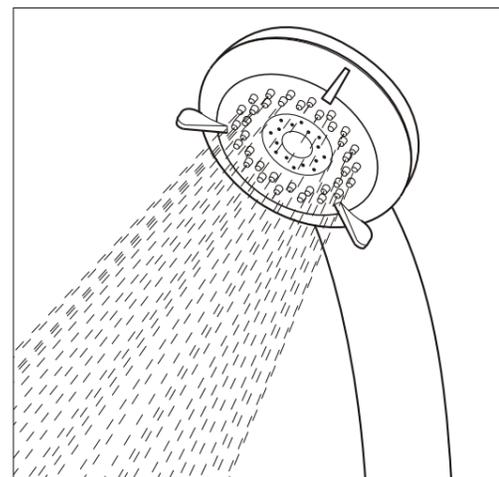
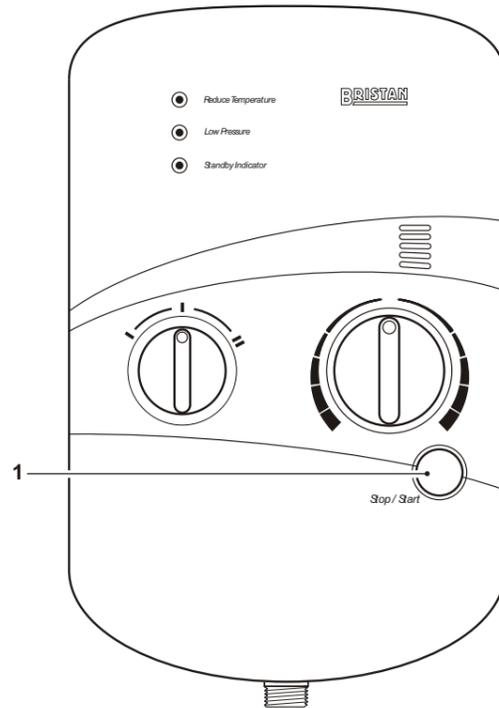

# Electrical Requirements

**Warning:** This appliance **MUST** be earthed!

	Rating at 240V	Rating at 230V	Cable Size
Bristan B85	8.5kW	7.8kW	6mm <sup>2</sup>
Bristan B95	9.5kW	8.7kW	10mm <sup>2</sup>
Bristan B104	10.34kW	9.5kW	10mm <sup>2</sup>

The Electrical Installation and Circuit Protection of this shower must comply with I.E.E. Wiring Regulations and should be checked by a qualified electrician prior to use.

**Please note:** You must switch off the power at the consumer unit and remove the correct circuit fuse before making any electrical connection.

The shower must only be connected to a 230-240V ac supply. The electrical rating of your shower is on the pack or on the rating plate label.

The shower must be connected to its own independent electrical circuit. It must not be connected to a ring main, spur, power socket, or lighting circuit. You will need to check the mains fuse box has a spare fuse way capable of taking the fuse or mcb (miniature circuit breaker) necessary for the shower. The main fuse box must have a main switch rating of 80A or above.

If you don't have a spare fuse way or the rating at the main fuse box is below 80A, you should seek advice from an electrician and may need a new consumer unit - specifically for the shower.

**Supplementary bonding:** All accessible conductive (metal) parts within the bathroom or shower room must be bonded to earth using a minimum cable size 4.0mm<sup>2</sup> (2.5mm<sup>2</sup> if cable is mechanically protected). Typically, metal baths, radiators, water pipes, taps and metal waste fittings must all be electrically bonded together.

**Important:** Voltage drop in the supply to the premises, due to heavy local demand, will affect the performance of your shower.

To ensure optimum performance and trouble-free service from your shower, care should be taken during installation. This shower incorporates a pressure relief device, in the unlikely event of the device discharging, it is advisable to position the shower unit over the bath or shower tray.

To gain the optimum power possible from this shower unit try to find the shortest possible route from the consumer unit to the shower to run your cable.

A separate and permanently connected cable must be taken from the customer unit directly to the shower via a double pole switch with a minimum contact separation gap of 3mm in all poles. It is recommended that a residual current device 45A(RCD) formerly known as an earth leakage circuit breaker (ELCB) with a tripping current of 30mA, is incorporated in the circuit.

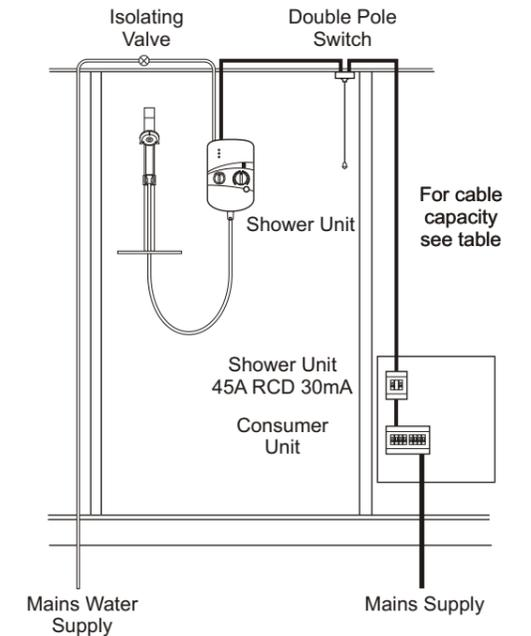

For cable capacity see table

## Electrical Requirements cont.

It is recommended that a residual current device (RCD) formerly known as an earth leakage circuit breaker (ELCB) with a tripping current of 30mA is incorporated in the circuit. This may be part of the existing consumer unit or a separate unit.

The isolating switch can be a ceiling mounted pull cord switch within the bathroom or wall mounted in an adjacent room. The power switch must be easily accessible and identifiable as the supply to the shower.

The current carrying capacity of the circuit must be at least that of the shower circuit (see table A).

In domestic installations you must ensure that the electrical supply and existing fuse board are adequately rated.

Do not turn on the electrical supply unit until the plumbing has been completed and the shower cover re-fitted.

**Table A**

<b>Twin and Earth PVC Insulated Cable</b>		
<b>Current Carrying Capacity</b>		
<b>In an insulated wall</b>	<b>In conduit or trunking</b>	<b>Clipped direct or buried in a non insulated wall</b>
6mm <sup>2</sup> 32A	6mm <sup>2</sup> 38A	6mm <sup>2</sup> 46A
10mm <sup>2</sup> 43A	10mm <sup>2</sup> 52A	10mm <sup>2</sup> 63A

**Note: Cable selection is dependant on derating factors**

## Commissioning - Testing the System

Before using the shower for the first time, it should receive a final flush through to remove any remaining debris that may be in the pipe work or hose and to ensure the heater unit contains water before the electrical elements are switched on.

Remove the showerhead from the hose and if not already attached, attach the hose to the outlet port. The power control knob must be switched to the cold position 'blue' (heating elements will not be on).

The temperature control knob must be set fully clockwise to full hot/ minimum flow.

Turn on the water supply and inspect for water tightness.

Turn on the electricity supply and the 'standby light' will illuminate.

Press the STOP/START button, wait approximately 30 seconds for the water to flow correctly. Once the water has flowed for a further 10 seconds, rotate the temperature control knob from the fully clockwise position to the fully anti-clockwise position. Repeat this procedure several times.

Once you are satisfied that the system has been flushed through thoroughly, press the STOP/START button to stop the flow.

Re-fit the showerhead to the hose, insert hose rubber to seal the joint; please ensure that the hose passes through the larger hole in the soap dish. The showerhead is attached to the riser rail by inserting the conical hose nut into the movable slider.

Your shower is now ready for first use.

# Fixing Your Shower to the Wall

**Warning!** Please check for any hidden pipes and cables before drilling holes in the wall.

Remove the three cover retaining screws and lift off the cover. Do not try to remove the control knobs from the cover. They are an integral part of the cover and must not be removed.

Depending on your choice of cold-water entry direction, you may need to remove thin areas of plastic cover to facilitate pipe work entry to the unit.

If you are fitting the unit to a partition wall or a wall of particularly soft friable substrate, you will need specialist fixings. For specialist fixings advice visit [userview.co.uk/fixings](http://userview.co.uk/fixings) or contact Customer Services on 0844 7016273.

Select the position for the shower and offer the shower back plate to the wall, marking the 3 fixing points with a suitable pencil. Remove the back plate from the wall, drill 6mm diameter holes to a depth of 35mm, insert the wall plugs and secure the back plate to the wall ensuring it is perfectly straight using the 35mm screws provided.

Re-fit cover ensuring the Power Control knob is at the 12 o'clock position and the Temperature Control knob is turned to the highest temperature point.

## Fitting the Riser Rail

Before proceeding with fitting the rail, identify each of the items supplied using the illustration on your right.

The Slider should not be removed from the rail during fitting. The top of the slider has a smooth profile, whereas the underside has a recess revealing the grooves on the handset holder.

Fit the soap dish onto the bottom end of the rail and secure using the small screw from the kit.

Position the rail on the wall, bearing in mind the different heights of people likely to use the shower and the length of the hose when connected to the shower and passed through the retaining hole in the soap dish. Mark the wall to indicate the upper fixing screw position. Screw centres are 605mm (approx. 23 - inches,) apart.

**Warning!** Please check for any hidden pipes and cables before drilling holes in the wall.

Drill the wall at the marked fixing position using a 6mm drill to a depth of 35mm and loosely fix the rail end, checking that the rail is hanging vertically using the spirit level incorporated into the top end of the rail. The bubble should be exactly between the two lines on the spirit level body. Mark the position for the lower fixing screw, move the rail to one side, drill the wall, and fix the lower end of the rail.

Check that the rail is perfectly vertical and tighten both fixing screws. Slide the end cap into position on the top end of the rail, and fit the screw cover into the recess in the soap dish.

When fitting the hose, it should pass through the larger hole of the soap dish.

**Note:** The hose nut and not the handset handle, fits into the slider. The slider moves more freely on the rail if gripped next to the rail, rather than at the handset.

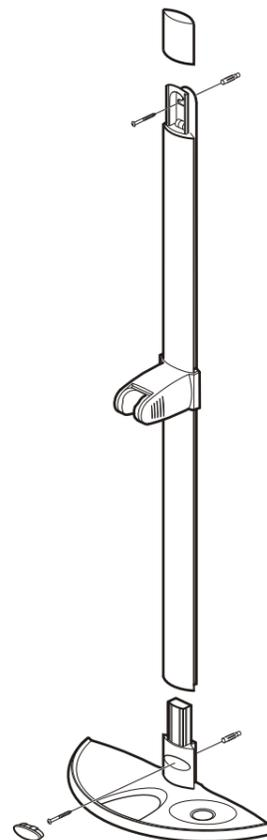
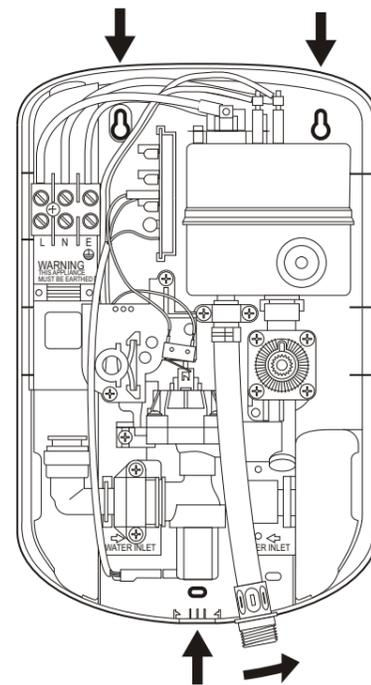

# Water Requirements

The installation must comply with all Water Authority and Building By-laws and Regulations.

If the shower is to be installed in a hard water area, we recommend that an in-line scale reducer is fitted. Please refer to your supplier for advice.

**Warning:** The shower must not be installed in an area subject to freezing conditions. Do not use if you suspect the shower is frozen, this will damage the shower unit.

The shower must be connected to a mains water supply with a minimum running pressure of 1.0bar (100kPa, 14.5psi) at a minimum flow rate of nine litres per minute. The maximum static pressure must be 10bar (1MPa, 145psi).

During periods of high ambient temperatures (e.g. hot summer days), it may be necessary to select a lower power setting in order to achieve your ideal shower temperature.

If it is intended to operate the shower at pressures above the maximum or below the minimum stated, contact our Customer Services for advice **0844 7016273**

Water regulation stipulates that the showerhead be 'constrained by a fixed or sliding attachment so that it can only discharge water at a point not less than 20mm above the spill over level of the bath or shower tray or other fixed appliance'.

If a showerhead can sit within a bath, basin or shower tray, you must fit a double check valve in the supply pipe work to prevent back siphonage. If the showerhead can sit within a WC then the air gap should be a type AUK3 not less than 20mm or twice the diameter of the inlet pipe to the fitting, whichever is the greater.

## Pressure Relief Device (PRD)

A pressure relief device is designed into this shower. The pressure relief device provides protection should an excessive build up of pressure occur within the shower unit.

Do not use the shower with a damaged or kinked shower hose or blocked handset. This may trigger the PRD which will discharge through the vent in the front cover area. During the 'Commissioning' phase, the temperature control should be turned to the minimum flow setting and the handset removed from the hose.

In the event of the PRD activating, it is most likely water will be dispersed from the vent above the temperature control knob. If this happens, switch off the electricity and water supplies to the shower at the mains and contact Customer Services in order to obtain a new pressure relief device (PRD).

**IMPORTANT!** The shower unit must be fitted to a flat, tiled and fully waterproof surface. Under no circumstances should the shower unit be attached to a wall and then tiled up to the edges. The unit must be fixed on top of the wall surface.

**Note:** Do not seal the air gap between the wall and the unit with silicon sealant or similar gap filler. The gap is required to discharge condensation.

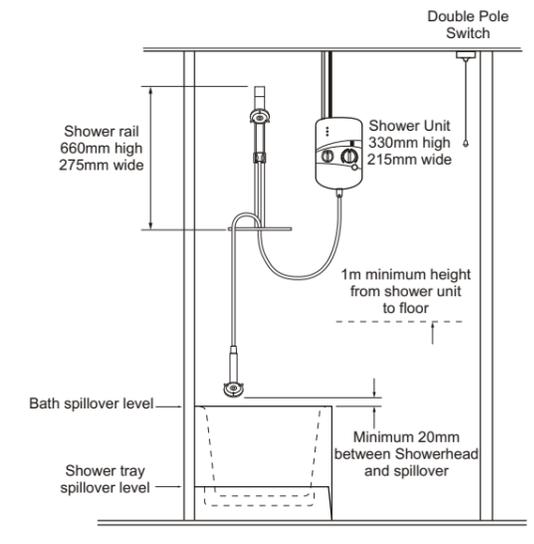

# Plumbing Connections

**Warning!** The outlet of the shower acts as a vent and must not be blocked, restricted or connected to any tap/ closure device other than the handset supplied.

Do not solder within 300mm of the shower unit or allow solder or flux to fall onto the casings. Compression fittings must **not** be used to connect to the shower inlet.

**Important:** An additional independent stop valve complying with the current water regulations must be fitted in the mains water supply as a means of isolating the supply to the unit for servicing and/or maintenance work.

It is essential that all pipe work is flushed through to remove debris and swarf that could otherwise damage the unit. Once the pipe work has been flushed through, turn off the water supply at the stop valve.

Connect the mains water supply to the inlet port of the shower using 15mm copper pipe (BS EN1057) or 15mm PEX plastic pipe. Do not use stainless steel pipework. If using chrome plated pipe ensure that the first 25mm of plating is carefully removed to prevent damage to the sealing surface. (see inlet entry options below).

## Inlet Entry Options

The pipe work can enter the shower unit from 5 different positions. Top left, bottom left, rear left, rear right or bottom right.

### To top or bottom left positions

The shower unit should come supplied with the inlet connection set for a bottom left position. To change it to a top left position:

Swivel the connector elbow from facing downward to facing upward.

### To bottom right position

Unfasten the two screws securing the inlet connector elbow clamp (1). Lift the outlet connection (2) from its position at the bottom of the unit and hold it up out of the way. Pull the connector elbow towards you and over to the right hand side with the inlet entry point facing down. Refasten the clamp and replace the outlet connection.

### To rear entry position

Swivel the connector elbow to face a rear entry pipe connection. If the pipework entry is from the rear, ensure that there is space left around the push-fit elbow for future servicing. Bring the cold water pipe to the shower position and connect to the inlet elbow.

## Connection

The inlet pipe connection into the elbow is a self-seal push-fit type. All burrs and rough edges must be removed from the end of the tube before attempting. If a chrome plated tube is used, remove the first 25mm of plating.

To release the pipe work from the push-fit type fitting, press and hold the collett against the elbow and pull the pipe out of the fitting.

Turn on the water supply and inspect for water leaks at the shower inlet. Once inspected-turn off the water supply.

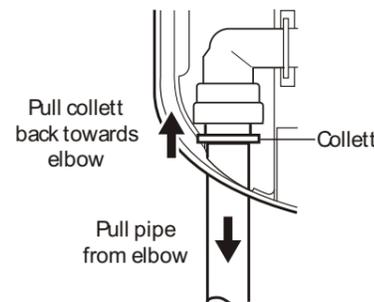
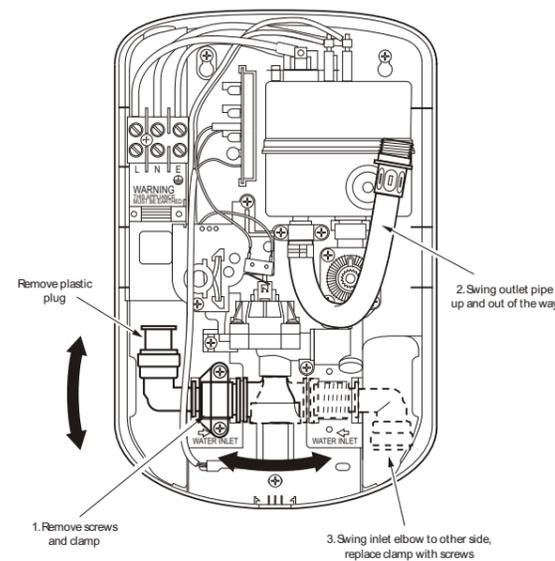
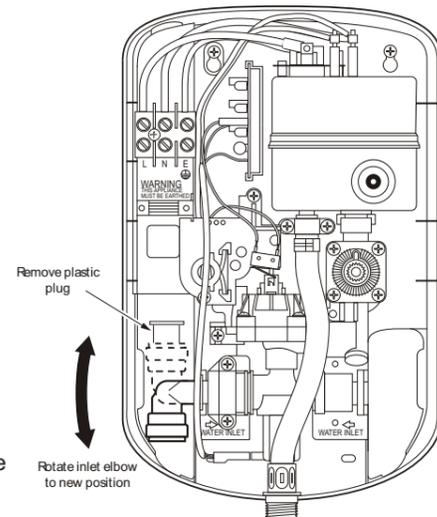

# Electrical Connections

**Warning!** This appliance and all connecting pipework must be earthed.

- Ensure that an earth continuity conductor is securely and permanently connected to all exposed, metal parts of other services and appliances within the room where the shower is installed.
- All cables **must** conform to the relevant tables within the I.E.E Regulations. The supply cable can be surface mounted and clipped, recessed or in conduit as detailed within the I.E.E Regulations.

**Switch OFF the electricity supply at the consumer unit and remove the correct circuit fuse.**

The power cable entry point is shown on the diagram. The cable can be surface clipped, hidden or via 20mm conduit. However, conduit entry can only be from the rear of this unit. Electrical connection to be made at the terminal block as follows:

Earth cable to the terminal marked with the Earth symbol **E**

Neutral cable to the terminal marked **N**

Live cable to the terminal marked **L**

**Important: Terminals must be fully tightened onto the cables ensuring that no cable insulation is trapped under the screws. It must be metal to metal. Loose connections can result in the cables overheating.**

The supply cable earth conductor must be sleeved. The supply cable must be secured by routing through conduit or in trunking or by being embedded in the wall in accordance with current I.E.E. regulations.

Secure the supply cable using the clamp, which is reversible for use with 6mm<sup>2</sup> or 10mm<sup>2</sup> cables. If the cable size used is greater than 10mm<sup>2</sup>, the clamp should be discarded.

**Warning! Do not restore power to the shower unit until the cover has been fully fitted.**

Fit the cover onto the back plate ensuring no cables or pipes are trapped between both parts preventing the cover from closing correctly.

- Rotate the power control spindle with narrow part facing 12 o'clock.
- Rotate the splined temperature control spindle fully clockwise.
- Set the left hand power control knob with the index mark at 12 o'clock.

- Set the right hand temperature control knob with the index mark at 4 o'clock (full hot).

- If the clicker (Re: Part no. 5 page 14) has been removed then it must be re-fitted as follows:

Rotate the spindle fully clockwise to the stop position. Fit the clicker with the aim to the left of the stop (11 o'clock position).

- Locate cover in position ensuring wiring is not trapped.

- (**Note:** slight angular adjustment of the knobs may be required to locate cover correctly).

- Secure using the 3 fixing screws supplied.

