

# SEMI FRAMELESS PIVOT DOOR (V2)

## Installation / Maintenance Instructions

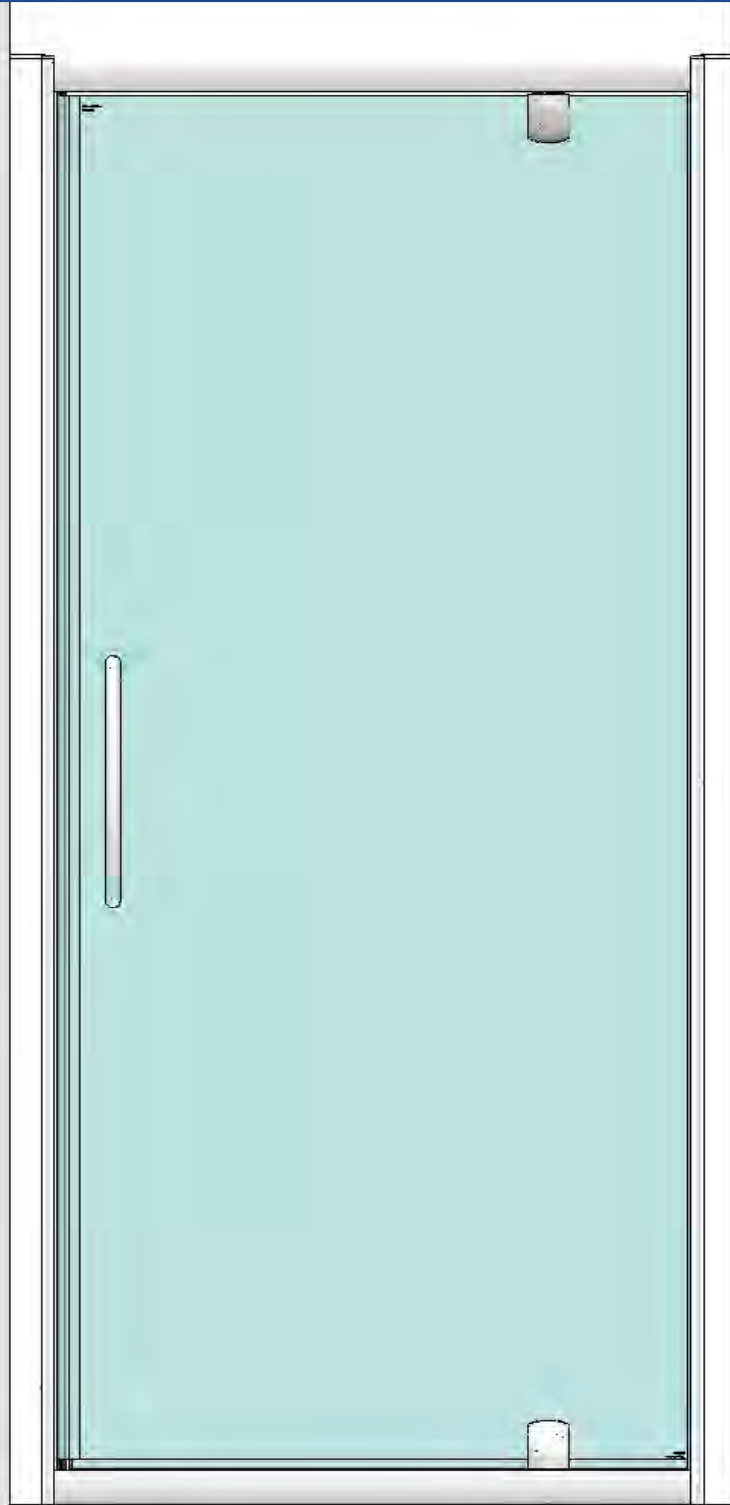

## IMPORTANT NOTES :

Please Read Carefully & Retain these instructions for Future Reference.

1. For ease & safety we advise that two persons assemble this product.
2. Protect shower tray surfaces at all times.
3. Check for cables, pipes etc before drilling walls.
4. Ensure all surfaces are dry, clean & free of loose debris / dust.
5. Unpack goods with care (small parts can become lodged in packaging & inadvertently discarded). Check parts supplied against parts & fittings listed herein. Damaged parts / Omissions may be resolved by calling Lakes Bathrooms Helpline.
6. Whilst precautions are taken in manufacture, care must be taken when handling as rail ends may have sharp edges.
7. Before commencing, check :
  - a) shower tray is level & completely sealed to finished / tiled walls.
  - b) finished walls are sound & free of cracks loose tiles / grout.
8. AFTER INSTALLATION, DO NOT 'WET' ENCLOSURE FOR 48 HOURS TO ENSURE FULL CURE OF SILICONE SEALANT.

## USE :

### General Care & Maintenance.

Providing this product is installed & operated in accordance with these instructions, problems should not arise. However should maintenance be required it should be carried out by a competent person with reference to these instructions. Before any work is carried out the root cause of the problem must be identified. Lakes Bathrooms service engineers are available if necessary to consult / carry out remedial work. Call Lakes Bathrooms HELPLINE.

### Cleaning.

(Every one to two weeks depending on local water {hardness} conditions).

All glass panels in this product have a hydrophobic coating aiding 'runoff' of water droplets, reducing the need for frequent cleaning. For best appearance / product life however, regular cleaning is recommended.

Use ONLY mild soap / detergent solutions to clean. Rinse with water, squeegee glass panels & wipe frames dry with a soft cloth. Under no circumstances should abrasive, caustic or scouring products be used. Cleaning products should have pH value 4 ~ 8.

DO NOT use 'spray & leave' type cleaning products.

Non compliance with these cleaning instructions may cause plated / painted finishes to deteriorate & could adversely affect safe operation of the enclosure.

Limescale ~ should a build up of limescale occur, remove using a 50:50 solution of white vinegar & water applied with a soft cloth & rinsed / dried thoroughly afterwards.

### Daily Care.

To prevent the build up of limescale, do not allow water droplets to dry on glass or frames. After showering, rinse with water, remove droplets from glass with a squeegee & wipe frame with a soft cloth.

### Customer Service.

Quality Guarantee : Lakes Bathrooms Ltd guarantee Shower Doors & Enclosures against any manufacturing or material defects for the lifetime of the product. We will resolve defects free of charge by repairing / replacing parts as we feel necessary. To be 'free of charge' service work must be carried out by Lakes Bathrooms or approved agents.

Not Covered by this Guarantee : Damage or defects that result from improper installation, improper use, or lack of maintenance (including limescale buildup). Damage or defects that result from repairs / modifications undertaken by unauthorized persons. This guarantee is in addition to statutory & other legal rights.

What to do if something goes wrong : Should the product not function correctly on initial use, firstly, contact the installer to check that unit installation & commissioning are in accordance with these instructions. Should this not resolve difficulties or should performance decline, consult 'Troubleshooting' section to see if simple home maintenance is needed. Alternatively our HELPLINE staff can assist, or if necessary arrange for a service engineer to visit.

Spares : We maintain extensive spare part stocks. Spares can be ordered / purchased from your retailer in the first instance. Parts will normally be dispatched within two working days from order placement. Pro Forma invoices will be sent for cheque payments.

**SUPPLIED PARTS :**

**Pivot Door Assembly: Comprising**

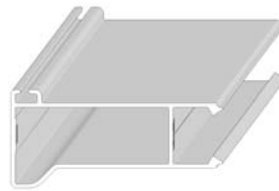
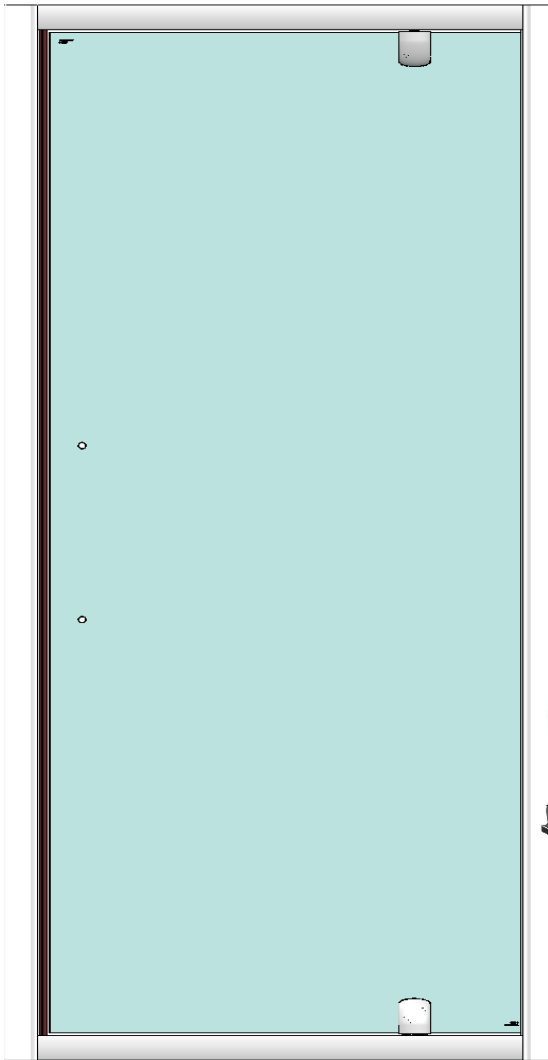

Vertical Rail  
(Hinge Side 1x)

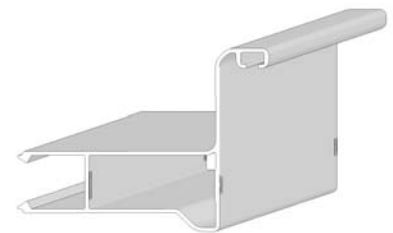

Vertical Rail  
(Magnet Side 1x)



Horizontal Rail  
(2x Handed Pair)



Hinge Boss  
(Frame 2x)  
&

3.5 x 12 long self tapping csk head screw (6x)



3.5 x 40 long self tapping screw (8x)



Hinge Cover  
(2x)



Hinge Assy  
(Door 2x)

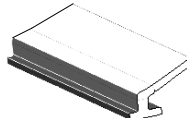

Frame Vertical Seal  
(1x)



Glazing Screw  
(4x)



Frame Magnet Seal (1x)



Glazing Washer  
(4x)

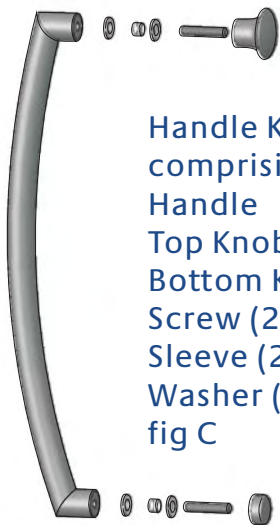

Handle Kit (1x) comprising:  
Handle  
Top Knob  
Bottom Knob  
Screw (2 per kit)  
Sleeve (2 per kit)  
Washer (4 per kit)  
fig C

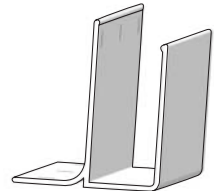

Wall Rail  
(1850mm 2x)  
fig A / B

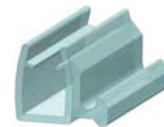

Door Gutter / Drip Seal  
(1x) fig C



End Cap for Bottom Seal  
(2x Handed Pair)



Door Magnetic Seal  
(1x) fig C



4 x 45 long self tapping screw (6x)  
fig A / B



7,5 x 39mm Wall Plug  
(6x) fig A / B



Top Cap ~ Hinge Side Vert Rail  
(2x Handed Pair) fig D



Top Cap ~ Magnet Side Vert Rail  
(2x Handed Pair) fig D



3.5 x 10 long self tapping pan head screw (6x) fig C



Cup Washer (12x) fig A / C



Decorative Screw Cover Cap (12x) fig C

Size	Adjustment (A)
700mm	660 / 720mm
750mm	720 / 780mm
800mm	760 / 820mm
900mm	840 / 900mm
1000mm	940 / 1000mm

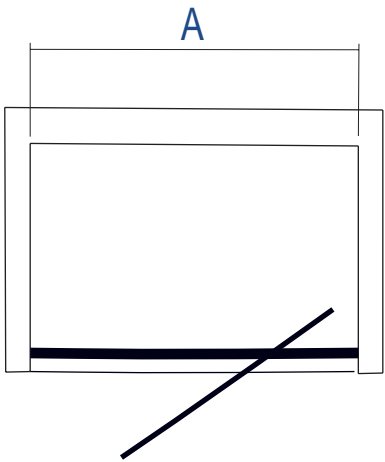

### Tools Required

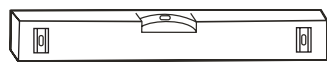

Spirit Level (with vertical 'bubble')

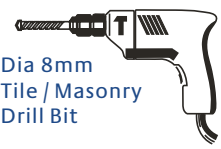

Dia 8mm  
Tile / Masonry  
Drill Bit



Tape  
Measure



Pencil



Dia 3mm  
HSS Drill Bit



Screwdriver (Pozi Drive)

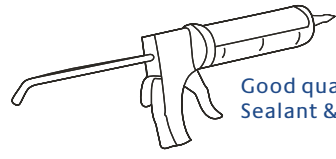

Good quality Silicone  
Sealant & applicator

Lakes Fully Framed Pivot Door is fully reversible, so is suitable for fitting with door to left or right hand side of enclosure.

Ensure tray is correctly levelled & that tray / wall (tile) joints are sealed & cured over entire length of tray sides (See Fig A) prior to fitting enclosure.

**DO NOT SEAL TRAY EDGES UPTO A FITTED ENCLOSURE !**

**A**

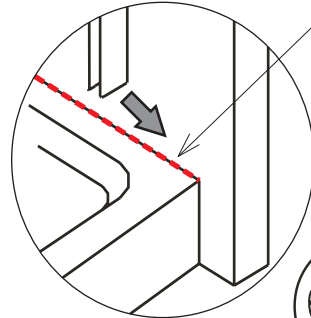
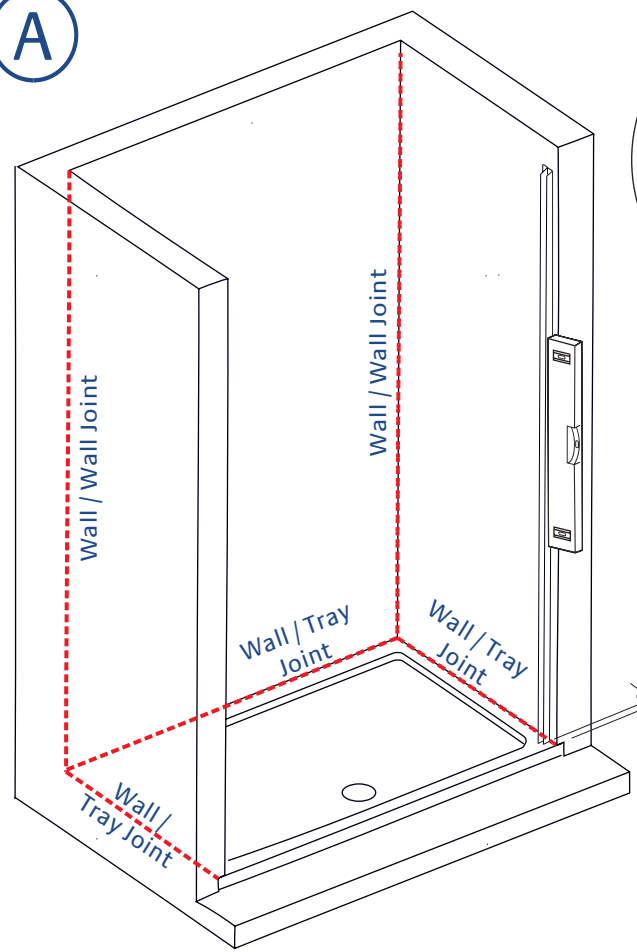

Ensure continuous silicone sealant bead before fitting wall rails



dia 4 x 45 lg

cup washer

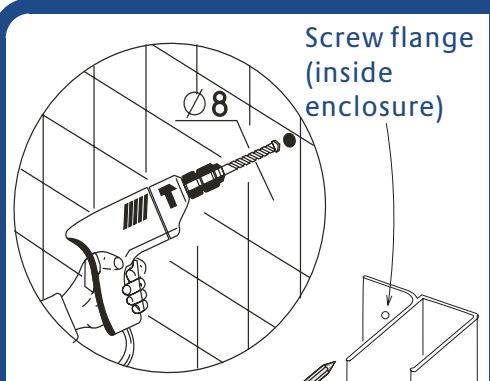

Screw flange (inside enclosure)

Measure & mark wall rail Positions. Mark fixing hole positions, drill & plug walls. Having decided required handing, FIT DOOR SIDE WALL RAIL ONLY AT THIS STAGE

B

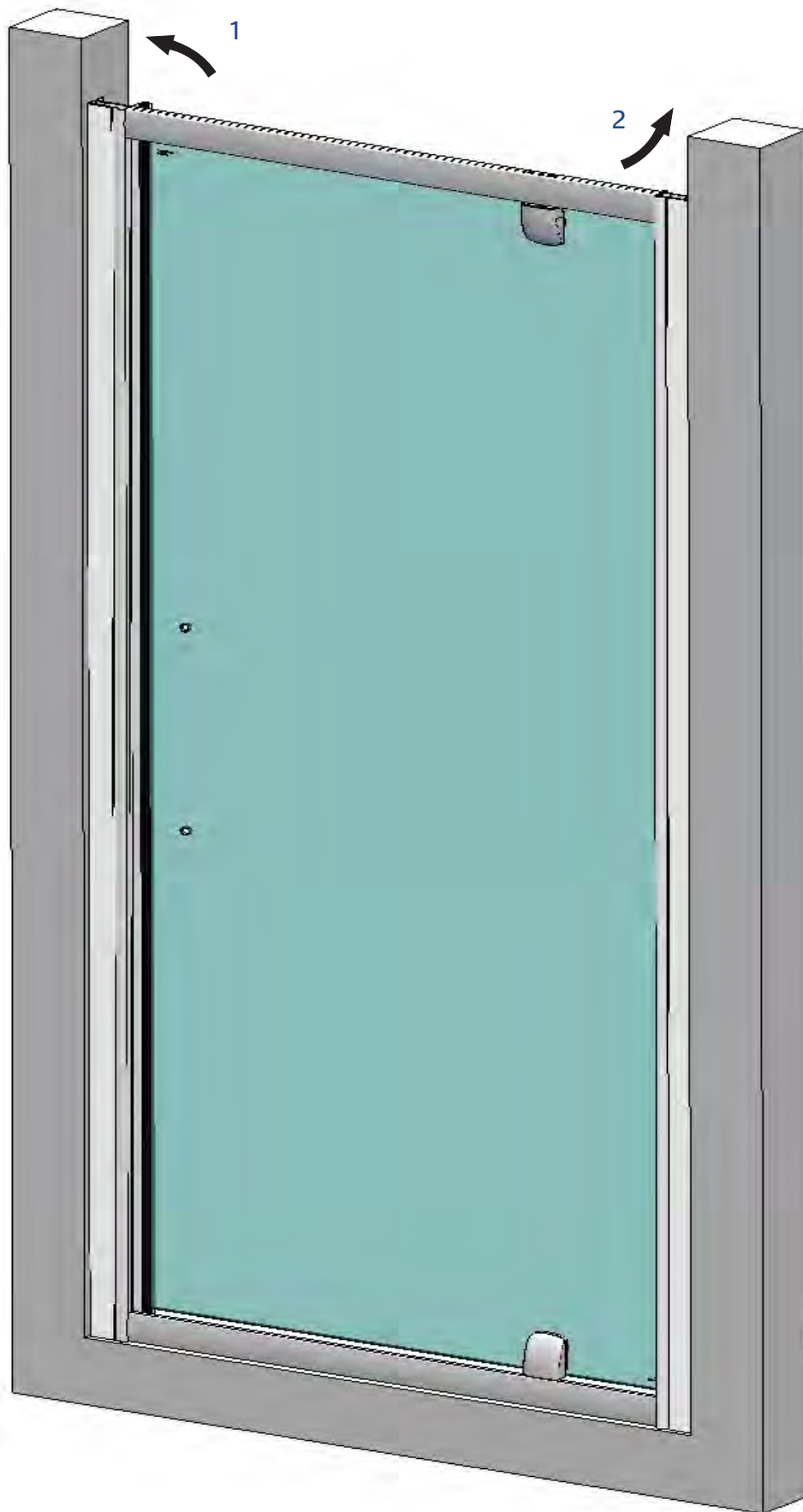

Push remaining wall rail fully onto hinge side.

Keeping unit upright, lift over tray &

1. Push door (magnet) side into fixed wall profile.

2. Push panel end back into alcove. Align & fix panel side wall profile to wall with 4 x 45 long pan head screws & cup washers (3 each).

**C** Fit door seals & handle

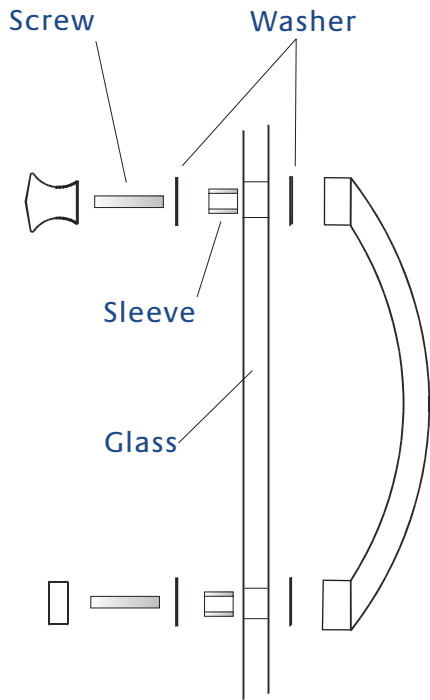

Handle Assembly

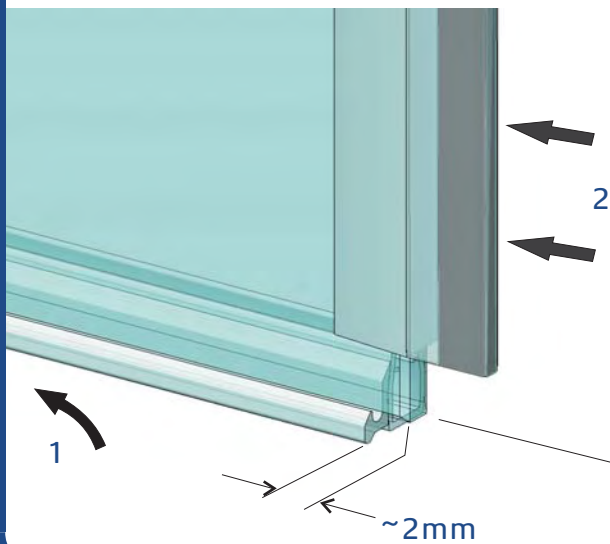
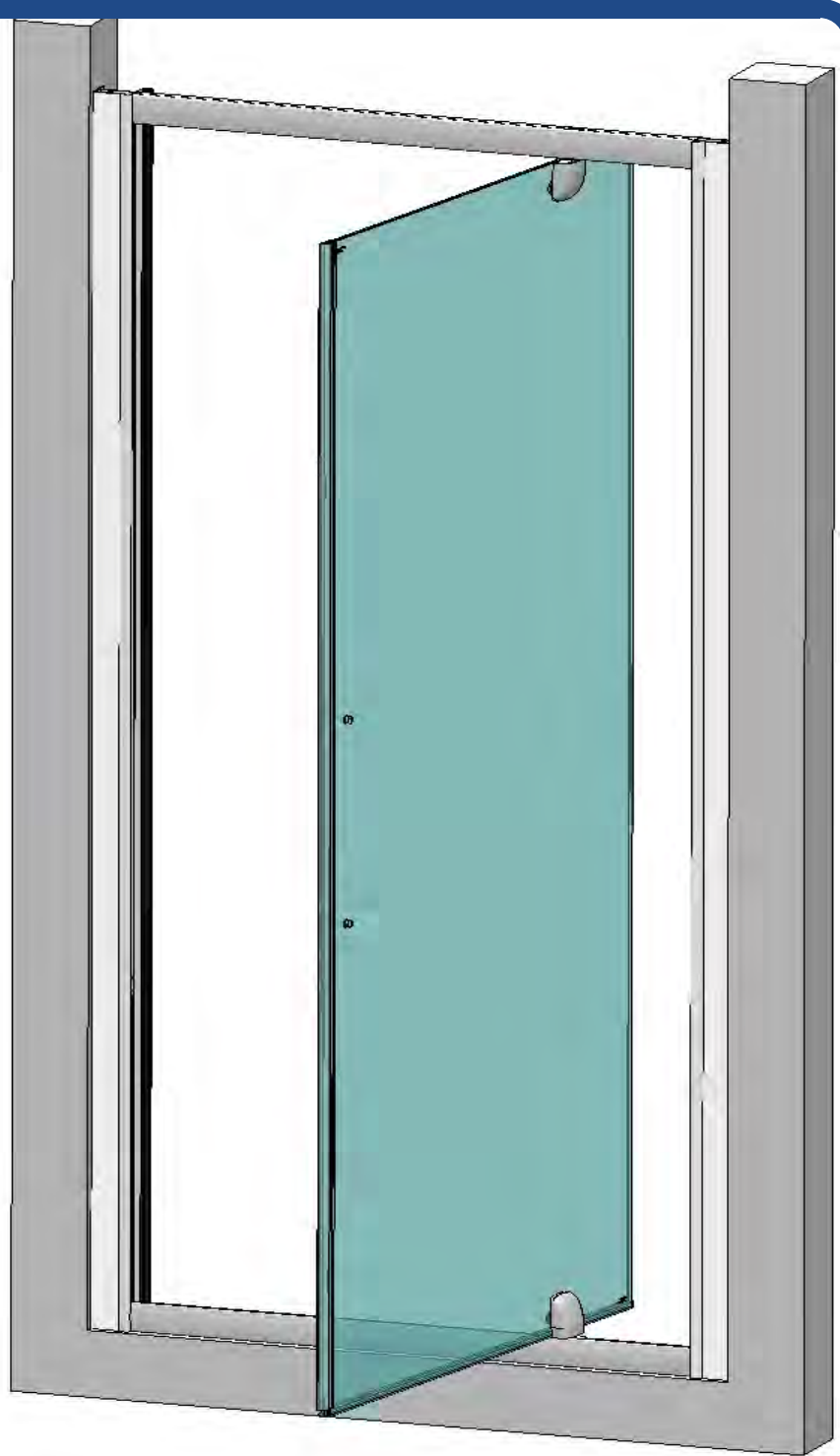

Note Seals may be 'wetted' to ease assembly.

1. With drip strip to inside, fit seal to bottom of door glass by sliding along & upward : correct seal position is reached with glass overhanging seal by approx 2mm.
2. With magnetic face to inside, push on magnetic seal as shown.
3. Select appropriate hand end cap, apply silicone sealant to cap & push into end of bottom seal ~ wipe of excess sealant with a damp cloth.

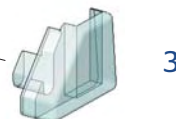

D

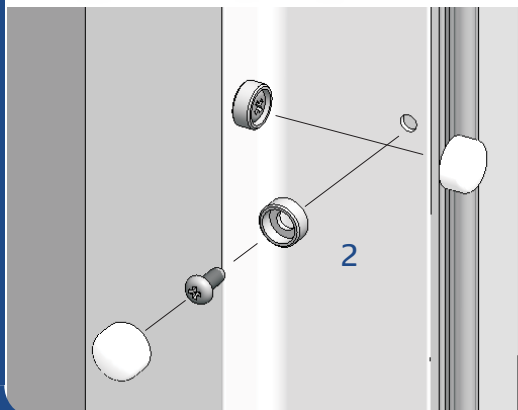
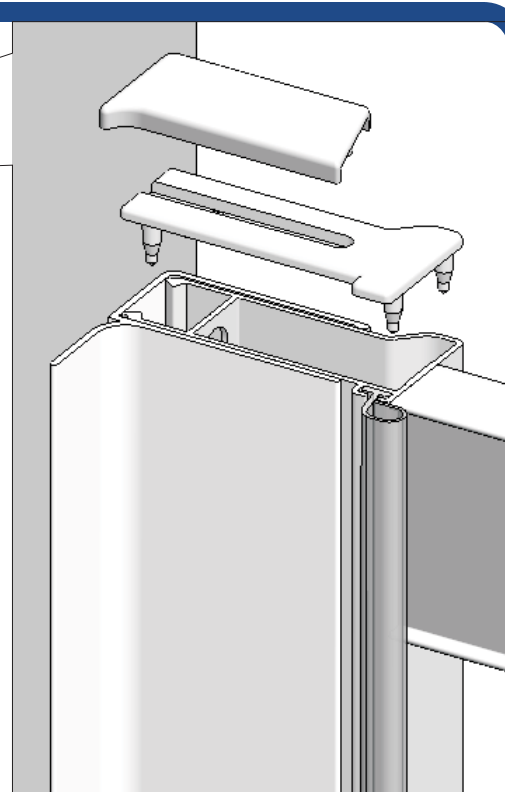
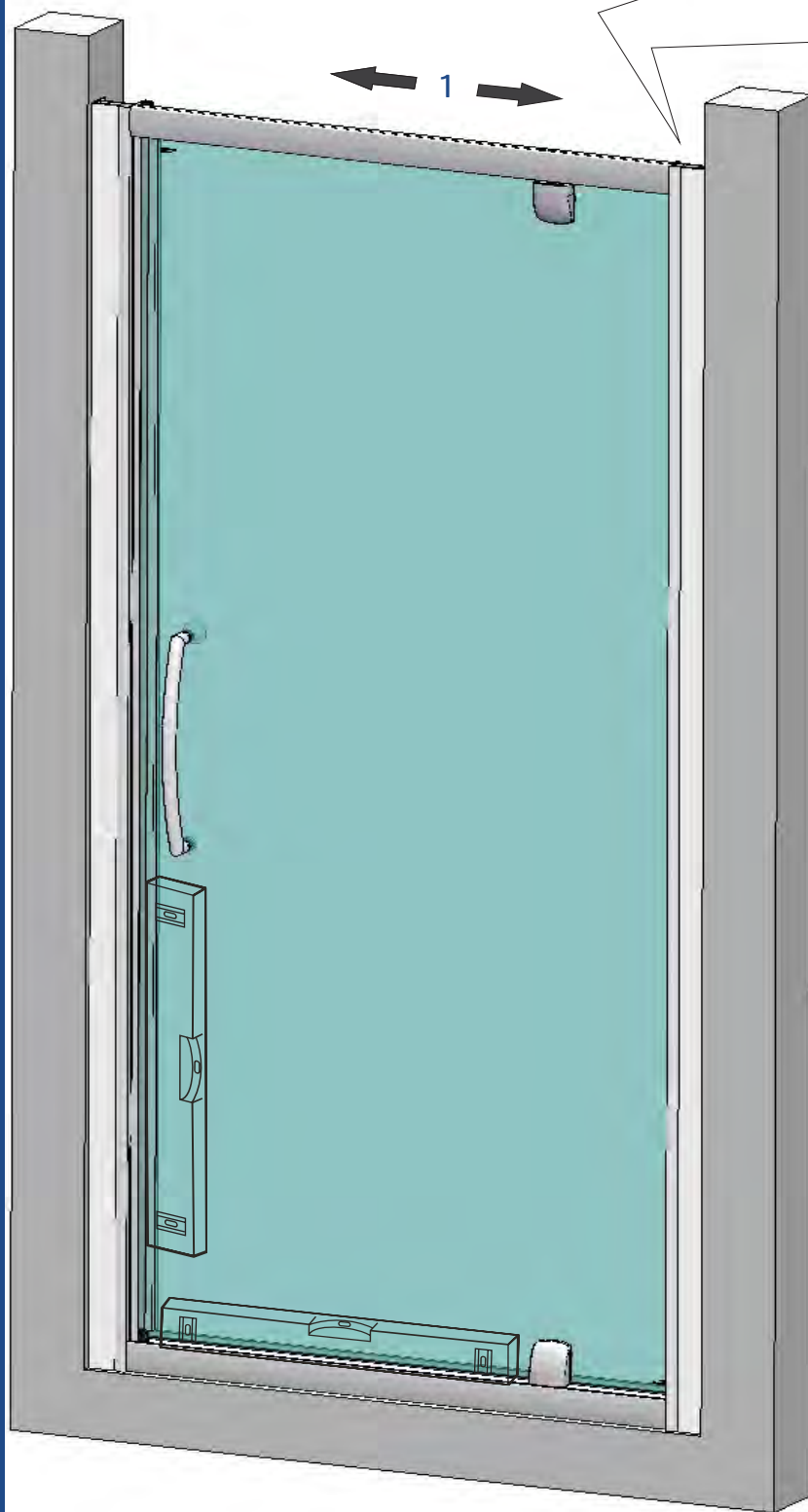

1. Centre enclosure in wall profiles & ensure that frame is plumb, door pivots freely & magnet seals hold & are in contact over full door height.
2. With door in open position, from inside enclosure, using wall rail holes as a guide, drill (dia 3mm) fit cup washer & screw main panel to wall rail using 3,5 x 10 long pan head screws (3x per wall rail). Push on decorative cover caps to ALL screws/washers (including wall rail screws).

E

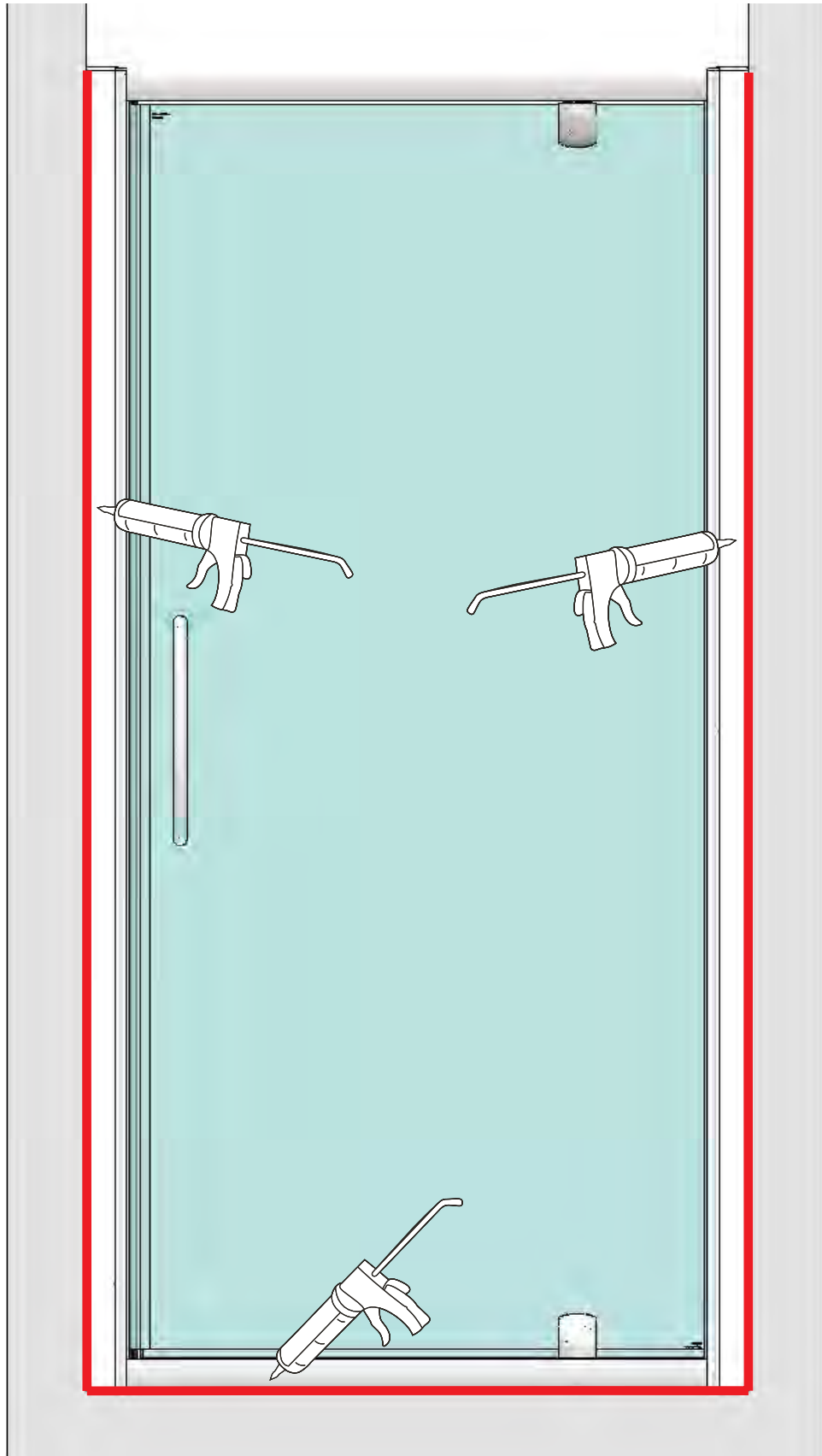

Use of good quality silicone sealant & cleaning / degreasing  
of all joint areas is recommended.  
Apply continuous silicone sealant bead as indicated EXTERNALLY ONLY



## BASIC TROUBLESHOOTING :

Door magnetic seals not meeting precisely / not holding :

Check plumb/level of frame & door alignment, adjust frame if necessary (see fig D).

Check magnet polarity, frame magnet may be removed, reversed & refitted to improve door 'closing'.

Leakage :

The sealing method described in these instructions relies on a continuous seal being applied between shower walls & tray before installing the enclosure (see fig A), it ensures a watertight seal around the perimeter of the enclosure to the shower walls & tray.

In the unlikely event of an enclosure leak, water will be visible on the outside of the enclosure itself, or around the perimeter silicone seal ONLY. Water / moisture appearing outside this area (ie at floor level) is normally due to incorrect tray installation.



Lakes Bathrooms Ltd  
Alexandra Way  
Ashchurch  
Tewkesbury  
Gloucestershire  
GL20 8NB

Service : England, Scotland, Wales

8.30am—5pm Mon~ Thurs

8.30am—4.30pm Fri

Tel / HELPLINE : 01684 853870

Fax : 01684 857411

[www.lakesbathrooms.co.uk](http://www.lakesbathrooms.co.uk)

email : [admin@lakesbathrooms.co.uk](mailto:admin@lakesbathrooms.co.uk)

Service : Northern Ireland  
Ian A Kernohan  
Firtrees  
Green Way Industrial Estate  
Conlig  
Northern Ireland  
BT23 7SU

8.30am - 5pm Mon~Thurs

8.30am - 4.30pm Fri

Tel : 02891 270233

Fax : 02891 270597

Email : [info@iakonline.com](mailto:info@iakonline.com)