

AQUALISA

Aspire[®]_{DL}

**Thermostatic mixer shower with 105mm
Harmony head**

Installation guide



Introduction	p.3
- Safety information	p.3
- Product specification	p.3
Connection to supplies	p.3
- Pipe sizing	p.4
- Flushing	p.4
- Filters	p.4
- Isolating valves	p.4
- Pressures	p.4
Gravity system	p.4
- Siting	p.5
- Pump installation	p.5
- Stored water capacities	p.5
Combination boiler systems	p.5
Balance high pressure systems	p.6
Typical water systems	p.7
System components	p.9
Valve installation instructions	p.10
- Aspire exposed valve	p.10
- Aspire concealed valve	p.13
Harmony shower head installation	p.16
- Adjustable height Harmony head	p.16
- Fixed Harmony head	p.19
User guide	
- Shower valves	p.21
- Adjustable height Harmony head	p.21
- Fixed Harmony head	p.22
Cleaning & maintenance	p.22
Commissioning	p.22
Trouble shooting guide	p.23

Introduction

The Aspire product range includes an exposed product complete with adjustable height shower head and a concealed valve with either an adjustable height or fixed shower head. Aspire valves feature separate flow and temperature controls. Aspire thermostatic valves provide close temperature stability and fail safe protection on appropriate high and low pressure systems. Please refer to the product specification section below.

If at any stage during installation you have any questions, please contact the Aqualisa customer helpline on 01959 560010 for assistance.

Safety information

This product must be installed by a competent person in accordance with all relevant current Water Supply Regulations.

THE SHOWER MUST NOT BE USED WITH A HOT WATER SUPPLY TEMPERATURE OVER 65°C.

The Aspire range is designed for domestic use only.

Product specification

Aspire products are suitable for all gravity, boosted gravity, balanced high pressure and combination boiler systems*. Pressure range 0.1bar – 10bar max (static).

*The combination boiler MUST have a minimum rating of 24kW (80,000 Btu) and be of the type fitted with a fully modulating gas valve.

If any doubt, please contact the appliance manufacturer before installation commences.

When fitted to combination boiler systems, Aspire shower valves have been designed to give optimum temperature control and stability from fully modulating combination boilers and instantaneous gas water heaters. The Aspire valves are supplied complete with flow regulators to control the incoming hot water flow rate into the cartridge. The following regulators should be fitted to suit the relevant rated appliance as listed below:

YELLOW	= 24kW (80,000Btu)
GREEN	= 28kW (100,000Btu)
BLUE	= 35+kW (120,000+Btu)

Please refer to pages 11 and 14 for fitting the regulator instructions.

Connections

Aspire products are designed for conventional supplies with HOT on the left and COLD on the right as viewed from the front.

Aspire shower valves incorporate 15mm compression fittings. Tube should be cut using a rotary type cutter.

If plastic pipe is used, the tube insert must not increase the tube diameter or extend the cut off length by more than 2mm.

Supply lines must be flushed clear of any debris before installation of the unit. Any debris accumulation in the shower valve and head may result in damage and poor performance.

Pipe sizing

Long pipe runs, on both inlet and outlet, will reduce the flow rate at the shower head. If long pipe runs are unavoidable, use copper pipe rather than plastic. If plastic pipe is used, minimise the number of elbows as pipe inserts are very restrictive. Consideration should be given to using 22mm plastic or copper pipe especially if a diverter valve is to be fitted.

Flushing

Some modern fluxes can be extremely corrosive and, if left in contact, will attack the working parts of the unit. All soldering must be completed and the pipe work thoroughly flushed out in accordance with current Water Supply Regulations prior to connection of the product.

Filters

To ensure ongoing optimum performance, Aspire products are protected by inlet filter assemblies in the internal waterways. Debris accumulation may result in reduced flow from the shower head and noisy operation.

As this condition is not covered by our standard warranty terms, it is suggested that the filters be removed and checked by a competent person. In the event of any difficulties please contact the Aqualisa customer helpline for assistance.

Isolating valves

Suitable full way isolation valves must be fitted to both supplies in accordance with current Water Supply Regulations and our terms of warranty.

Due to their restrictive characteristics, stopcocks and ball type valves that reduce the pipe bore size must not be used on gravity and boosted gravity installations.

Pressures

The Aspire cartridge is designed to operate from the mains at a maximum of 10bar. If the mains pressure is likely to exceed 10bar, a 'drop tight' PRV must be fitted on the supply pipe after the main stopcock. A setting of 3bar is recommended. It should be noted that daytime pressures approaching 8bar can rise above the stated maximum overnight.

A suitable PRV is available from Aqualisa.

Aspire products are not suitable for mixed supply systems, e.g. gravity hot and mains cold.

Gravity fed hot and cold supplies

Services must be installed according to good plumbing practice having regard to pipe sizing, long pipe runs and low head situations.

The cold supply for the valve assembly must be taken directly from the cold water storage system. The hot supply may be taken from the vent/draw off pipe of the hot water cylinder at a point below the cylinder connection or alternatively from the underside of the horizontal draw off.

Rising pipe work must NOT be connected into the horizontal draw off from the cylinder or to any point in the vent/draw off pipe above the cylinder connection.

CYLINDER TEMPERATURE IN EXCESS OF 65°C MAY RESULT IN POOR SHOWER PERFORMANCE

To minimise pressure loss we recommend that the hot and cold supplies are run in 22mm as close as reasonably possible to the mixing valve before reducing to 15mm.

Siting

For optimum performance, with gravity fed systems the distance between the bottom of the storage cistern and the shower head should be not less than 1m (when using an adjustable height head). If using a fixed head, the highest point of the pipe work must be below the underside of the cistern.

Please refer to the typical system layout on page 7.

Pump installation

UNDER NO CIRCUMSTANCES MUST A PUMP BE FITTED DIRECTLY TO THE WATER MAIN

A pump must only be used to boost the pressure from tank fed supplies.

A minimum 1 bar twin ended booster pump is recommended.

ENSURE THE MINIMUM GRAVITY FLOW RATE IS SUFFICIENT TO OPERATE THE PUMP FLOW SWITCHES.

PLEASE REFER TO THE MANUFACTURERS PUMP INSTALLATION GUIDE FOR PUMP INSTALLATION INFORMATION.

Please refer to the typical system layout on page 7.

Stored water capacities

The minimum capacity of the cold storage cistern should be not less than 225 litres (50 gallons). The capacity of the hot cylinder must be capable of meeting the anticipated demand.

Combination boiler/multipoint system

Aspire products are suitable for use with combination boiler systems. The combination boiler **MUST** have a minimum rating of 24kW (80,000 Btu) and be of the type fitted with a fully modulating gas valve. This is sufficient to operate one outlet at a time.

If in any doubt, please contact the appliance manufacturer before installation commences.

The cold supply can be taken from the nearest convenient mains supply and the hot supply can be taken from the nearest hot water draw off point. Account must be taken of the pressure drops that will occur when other draw off points are used while the shower is in use.

Please refer to the typical system layout on page 8.

When fitted to combination boiler systems, Aspire shower valves have been designed to give optimum temperature control and stability from fully modulating combination boilers and instantaneous gas water heaters. The Aspire valves are supplied complete with flow regulators to control the incoming hot water flow rate into the cartridge.

The following regulators should be fitted to suit the relevant rated appliance as listed below:

YELLOW = 24kW (80,000Btu)

GREEN = 28kW (100,000Btu)

BLUE = 35+kW (120,000+Btu)

Please refer to pages 11 and 14 for fitting the regulator instructions.

Balanced high pressure system

The cold water supply must be drawn from the same mains supply as that to the hot water system (down stream of the cylinder manufacturer's pressure limiting valve, where supplied) and the hot supply from the nearest convenient draw off point. Account must be taken of pressure drops that may occur when other draw off points are used while the shower is in use.

Please refer to the typical system layout on page 8.

Typical system diagrams

Typical gravity system installation

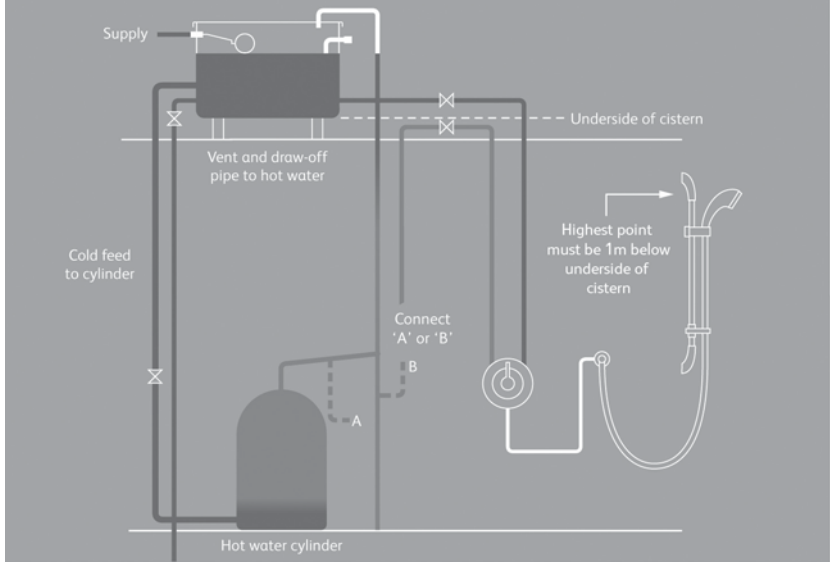

Typical pumped system installation

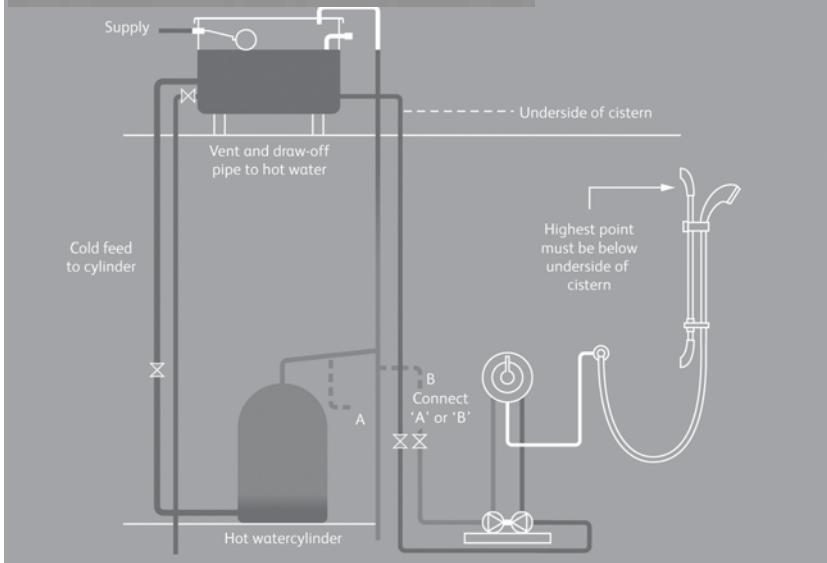

Typical system diagrams continued

Typical combination boiler system installation

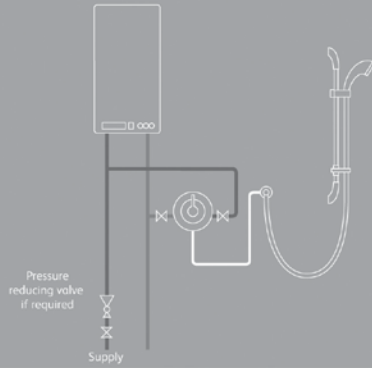

Typical UHW system installation

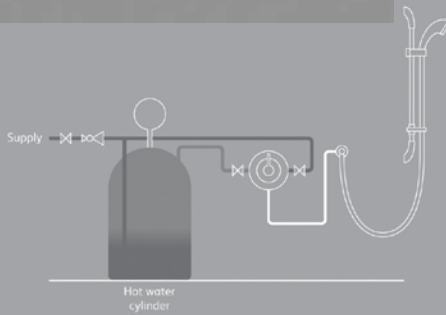

Typical thermal storage unit system installation

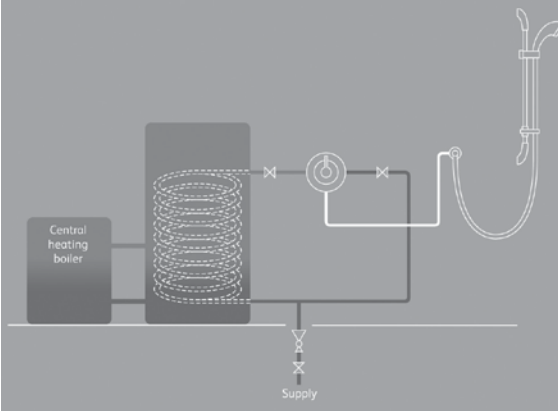

Components - Aspire concealed with adjustable 105mm Harmony head

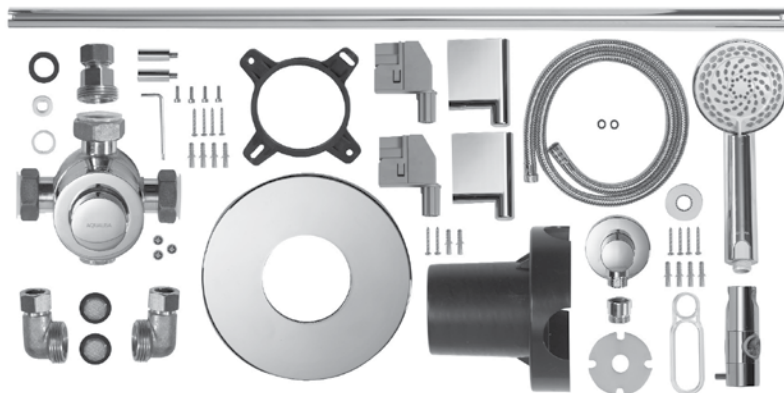

Components - Aspire concealed with fixed 105mm Harmony head

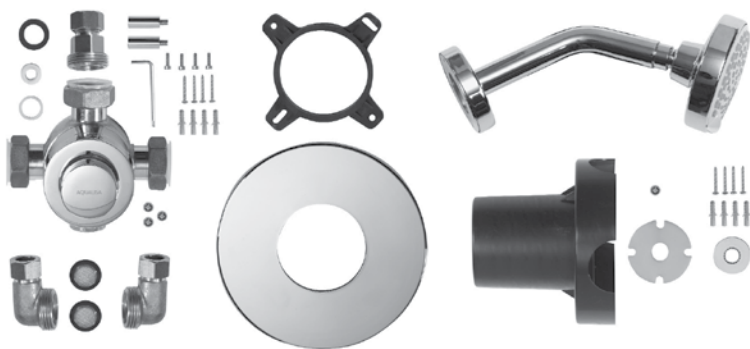

Components - Aspire exposed with adjustable 105mm Harmony head

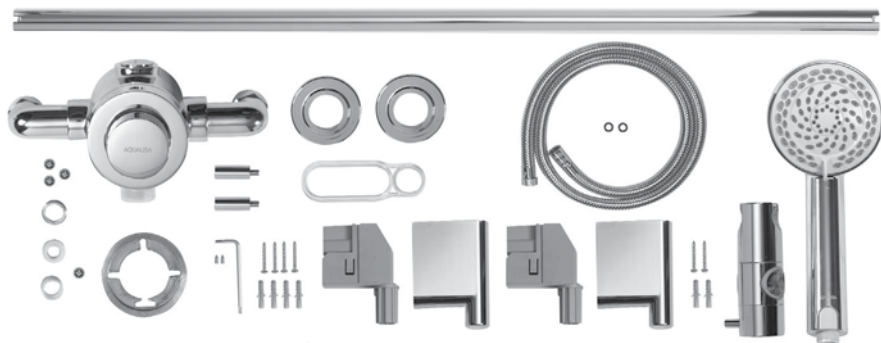

! In addition to the guide below it is essential that the written instructions overleaf are read and understood and that you have all the necessary components (shown on page 9) before commencing installation. Failure to install the product in accordance with these instructions may adversely affect the warranty terms and conditions. Do not undertake any part of this installation unless you are competent to do so. Prior to starting, ensure that you are familiar with the necessary plumbing regulations required to install the product correctly and safely.

1 Remove the black plastic protective cover from valve and set aside.



2 Fix the self adhesive fixing template to the wall and mark and prepare the fixing points and pipe entry positions, using the fixings provided, if suitable.



3 Prepare the suitable 15mm pipe work ensuring 15-25mm protrudes measured from the finished wall surface.

! Utilising existing pipe work

The inlet elbows are supplied at factory set 150mm centres. If required, the inlet centres can be adjusted from 148 – 155mm by winding the elbows into the body to reduce the inlet centre or out to increase the inlet centres.

If using existing pipe work, ensure the 15mm pipe protrudes 15-25mm from the finished wall and adjust the elbows accordingly. Alternatively, leave the existing nuts and olives attached if suitable, ensuring there is adequate purchase on the pipe work to create a water tight seal.

Offer the mounting plate onto the finished wall centred between the existing protruding pipe.

Mark and prepare the fixing points using the fixings provided, if suitable.

Rising or falling exposed pipe work

The multi-directional inlet elbows are supplied at factory set 150mm centres. If required, the inlet centres can be adjusted from 148 – 155mm by winding the elbows into the body to reduce the inlet centre or out to increase the inlet centres.



! Prepare suitable 15mm pipe work in the desired location.

If using existing 15mm pipe work, adjust the elbow centres accordingly.

Offer the mounting plate onto the finished wall centred between the existing exposed pipe.

Mark and prepare the fixing points using the fixings provided, if suitable.

4 Secure the mounting plate to the finished wall using the screws provided, if suitable.

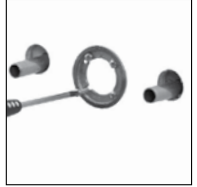

5 If the valve is being installed for use with a gas fired instantaneous (multipoint) water heater or a combination boiler, a flow regulator should be fitted to the hot water inlet. The inlet flow regulators are supplied as part of the system components and should be fitted to suit the relevant appliance as listed below:

YELLOW = 24kW (80,000Btu)

GREEN = 28kW (100,000Btu)

BLUE = 35+kW (120,000+Btu)

6 Place the relevant flow regulator within the small inlet flow regulator housing, ensuring the flow regulator o'ring faces the incoming flow when fitted.



7 Remove the hot inlet elbow from the valve assembly.

8 Fit the inlet flow regulator housing assembly within the elbow ensuring the flow regulator o'ring faces the incoming flow.



- 9** Place the brass fitting into the elbow and tighten using a suitable hexagonal key to secure the flow regulator assembly into position.



- 10** Refit the elbow to the valve assembly.

- 11** Place the grub screws into position in the valve body.

- 12** Offer the valve onto the mounting plate ensuring the elbows correctly align with the relevant pipework.



- 13** Secure the valve to the mounting plate using the hexagonal key provided.

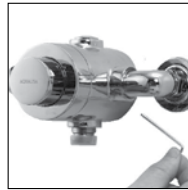

- 14** Secure the elbow fittings to the pipe work using a suitable tool, taking care not to overtighten.

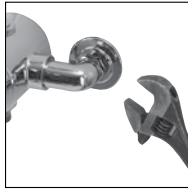

- 15** Remove the grub screws from the control levers.



16 Secure the grub screws to the valve control knobs using the hexagonal key provided.



17 Secure the control levers to the control knobs.



! If fitting this product for use with a high pressure system, we recommend fitting the outlet flow regulator provided. If required, place the flow regulator into the housing to create an assembly.

Place the flow regulator assembly into position within the valve outlet, ensuring the flow regulator o'ring faces the incoming flow.

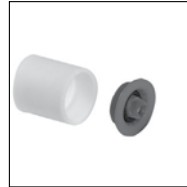

18 Ensure the hose washer is in position and secure the hose to the valve outlet.

Please refer to pages 16 to 19 for shower head installation instructions.

Aspire concealed valve installation

! In addition to the guide below it is essential that the written instructions overleaf are read and understood and that you have all the necessary components (shown on page 9) before commencing installation. Failure to install the product in accordance with these instructions may adversely affect the warranty terms and conditions. Do not undertake any part of this installation unless you are competent to do so. Prior to starting, ensure that you are familiar with the necessary plumbing regulations required to install the product correctly and safely.

1 If installing the product into a solid wall, chase out a suitable recess in the wall to receive the valve and pipe work. If installing the valve in a concealed panel mounted situation, in most cases it will be necessary to first install a suitable sound fixing in the cavity area before fixing the valve. A hole of $\text{\O}140\text{mm}$ is required to install the valve and gain access to the inlet and outlet connectors.

The valve needs to be mounted to the depth shown opposite. The distance between the 15mm inlet pipe centres is 145mm.

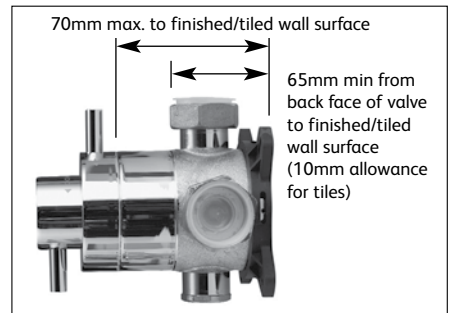

- 2** Remove the black protective cover / mortar guard from the valve assembly and set aside.



- 3** Place the mounting plate into position on the valve body ensuring the flat face aligns with the rear of the valve and secure using the bolts and hexagonal key provided.



- 4** If the valve is being installed for use with a gas fired instantaneous (multipoint) water heater or a combination boiler, a flow regulator should be fitted to the hot water inlet. The inlet flow regulators are supplied as part of the system components and should be fitted to suit the relevant appliance as listed below:

YELLOW = 24kW (80,000Btu)
GREEN = 28kW (100,000Btu)
BLUE = 35+kW (120,000+Btu)

- 5** Place the relevant flow regulator within the inlet flow regulator housing and place into the valve hot water inlet, ensuring the flow regulator o'ring faces the incoming flow when fitted.



- 6** Place the flow regulator retaining ring into position over the flow regulator housing assembly.



- 7** Ensuring the rubber washers/filters are in position, secure the elbows and outlet assemblies to the valve.



! The Aspire concealed valve is supplied with an outlet cap at the bottom of the valve assembly allowing for a top outlet connection. If required the cap can be removed with a suitable tool and refitted to the top outlet of the valve.

8 Prepare suitable 15mm inlet pipe work and construct a suitable 15mm outlet supply pipe to the desired location for the wall outlet or fixed head.

9 Place the valve into the required position within the wall and mark and prepare the fixing points using the fixings provided, if suitable.

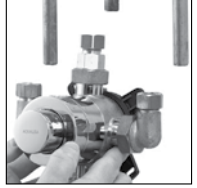

10 Secure the valve to the wall using the screws provided if suitable.



11 Secure the pipe work to the fittings using a suitable tool.

12 The valve can now be checked for leaks by rotating the flow control knob, ensuring the flow can discharge safely to waste. If all is sound, turn the valve off.

13 Refit the black mortar guard to the valve assembly and fill in the chase. Once the in-filling material has set, carefully remove the black mortar guard to expose the valve body.



! **THE MORTAR GUARD MUST BE USED**

14 Using a silicone based lubricant or liquid soap, lubricate the wall plate seal. Apply a thin bead of silicone mastic to the rear of the wall plate and carefully push the wall plate into position flush with the finished wall surface.



15 Remove the grub screws from the control levers.

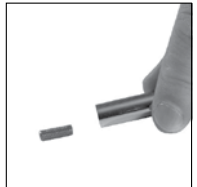

- 16** Secure the grub screws to the valve control knobs using the hexagonal key provided.

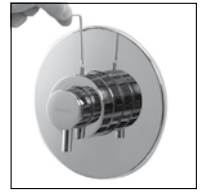

- 17** Secure the control levers to the control knobs.



Please refer to pages 16 to 20 for shower kit installation instructions.

Adjustable height Harmony head installation

Adjustable height head installation

The adjustable height heads are suitable to be fitted with either concealed or exposed shower valves. A wall outlet assembly is supplied for installation with a concealed valve. If fitting with an exposed valve please proceed to instruction 10.

- 1** Prepare pipework from the shower valve to the required position for the hose outlet using a $\varnothing 15$ mm copper pipe. Slide the wall spacer down the projecting pipe flush with the finished wall surface.

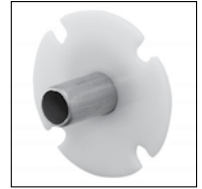

- 2** Slide the 15mm gripper ring down the projecting pipe flush with the wall spacer fitting.

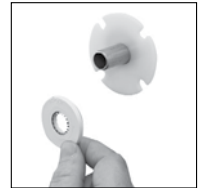

- 3** Trim the projecting pipe to a length of 15-20mm, measured from the front face of the grip ring, using a rotary type cutter. If a hacksaw is used, the pipe end must be carefully de-burred and chamfered.

- 4** Clean and lubricate the pipe using a suitable (silicone based) lubricant.

- 5** Remove the locking screw, rotate the chrome outlet assembly and remove the outlet from the wall mounting plate.



- 6** Place the wall outlet mounting plate onto the pipe assembly and mark and prepare the fixing points, using the fixings provided, if suitable.

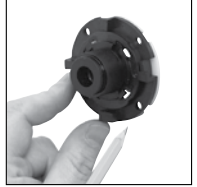

- 7** Secure the wall mounting plate to the wall using the screws provided, if suitable.

- 8** Place the wall outlet onto the mounting plate, with the hose connection in the 5 o'clock position and rotate clockwise until a stop is reached.



- 9** Refit the locking screw taking care not to overtighten.



- 10** Drill and plug 2 holes 776mm ± 3mm apart using the fixings provided, if suitable.

- 11** Fix the bottom rail bracket into position using the screws provided, if suitable.

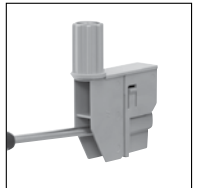

12 Ensuring the lever is in the upright position, pass the rail through the handset holder.

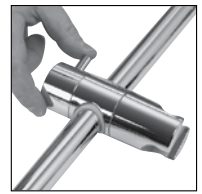

13 Carefully slide the gel hook onto the rail under the handset holder.



14 Current water supply regulations state that the handset should not be allowed to pass a point 25mm above the spill over level of the bath or shower tray. If this cannot be achieved, the hose must be passed through the gel hook which has also been designed to be utilised as a hose restraint.

15 Place the rail assembly onto the bottom fixing bracket taking care to engage the rail location slots on the bracket lugs.

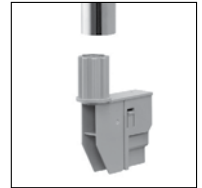

16 Place the top fixing bracket into position and secure to the wall using the screws provided, if suitable.

17 Slide the rail end covers onto the rail brackets and click into position.

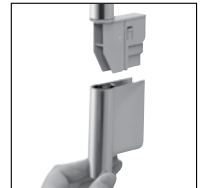

18 If fitting this product with a high pressure system, we recommend fitting the outlet flow regulator assembly provided.

! **Concealed valve**

If required, ensure the washer is in the correct position and secure the assembly to the wall outlet ensuring the flow regulator o'ring faces the incoming flow.



! Exposed valve

If required, place the flow regulator into the recess in the flow regulator housing. Place the flow regulator assembly into position inside the valve outlet ensuring the flow regulator o'ring faces the incoming flow.



19 Ensuring the hose washer is in position secure the hose to the valve or wall outlet hand tight only.



20 Pass the hose through the gel hook.

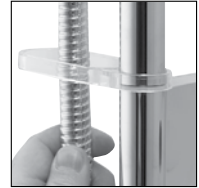

21 Ensuring the hose washers are in the correct position, depress the anti-swivel locking button on the handset and secure the handset to the hose. Place the handset into the handset holder.

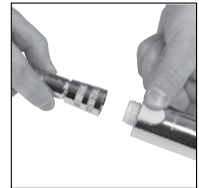

Fixed Harmony head installation

1 Prepare pipework from the shower valve to the required position for the fixed shower head using a Ø15mm copper pipe. Slide the wall spacer down the projecting pipe flush with the finished wall surface.

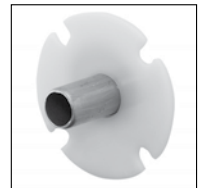

2 Slide the 15mm gripper ring down the projecting pipe flush with the wall spacer fitting.

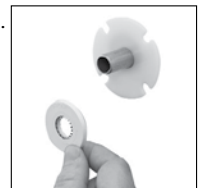

3 Trim the projecting pipe to a length of 20-50mm, measured from the front face of the grip ring, using a rotary type cutter. If a hacksaw is used, the pipe end must be carefully de-burred and chamfered.

4 Clean and lubricate the pipe using a suitable (silicone based) lubricant.

5 Carefully slide the fixed head cover plate down the fixed head arm taking care not to damage the plating.

6 Offer the fixed head arm into position over the pipework assembly and mark and prepare the fixing points using the fixings provided, if suitable.



7 Secure the head to the wall using the screws provided, if suitable.



8 If fitting this product with a high pressure system we recommend fitting the flow regulator provided to the fixed shower head. If required, remove the shower head from the arm and fit the flow regulator into the top of the head ensuring the flow regulator 'o ring faces the incoming flow. Refit the head to the arm ensuring the washer is correctly fitted.

9 Slide the cover plate into position flush with the finished wall surface.



Shower valve user guide

1. Turn the flow control lever anti-clockwise to turn the shower on to the desired flow rate.
2. Rotate the temperature control lever to select a comfortable showering temperature using the temperature markings as a guide.
3. Turn the flow control lever fully clockwise into the closed position after use.

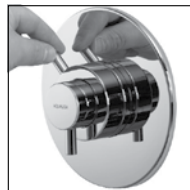

User guide – Adjustable height Harmony head

Adjustable head user guide

1. Rotate the sprayplate lever clockwise or anti-clockwise to select the desired spray pattern.

N.B. When the lever is in the 3 o'clock position when viewed from below, the water saving mode is selected. This provides the same spray pattern as position 3 but, depending on the water system the product is fitted to, offers up to 25% water saving.

2. To select the preferred height for the shower head, twist the lever to unlock and enable the slider to be moved up or down the rail. Twist the lever in the opposite direction, until a stop is reached to lock into position when the holder is in the desired location.
3. Angular adjustment is made by carefully but firmly pulling forwards or pushing back the shower head against the knuckle ratchet in the holder.



Fixed head user guide

1. Rotate the sprayplate lever clockwise or anti-clockwise to select the desired spray pattern.

N.B. When the lever is in the 3 o'clock position when viewed from below, the water saving mode is selected. This provides the same spray pattern as position 3 but, depending on the water system the product is fitted to, offers up to 25% water saving.

2. The angle of the fixed shower head can be adjusted. The shower head is mounted on a multi directional ball joint to allow for angular adjustment in any direction by carefully moving the shower head to the desired angle.



Cleaning and maintenance

Your Aqualisa shower system should be cleaned using only a soft cloth and washing up liquid.

DO NOT USE ABRASIVE CLEANERS.

To reduce the requirement for chemical descaling in hard water areas, the shower heads incorporate soft rub clean teats. Any scale build that may occur in any of the holes can be broken down by gently rubbing the flexible tips of the jets during use.

Should chemical descaling of the head become necessary remove the shower head and fully immerse the shower rose in a mild proprietary descalant.

It is imperative that descaling is carried out strictly in accordance with the manufacturer's instructions. Substances that are not suitable for plastics and electroplated surfaces must not be used.

Aspire valve commissioning

The Aspire thermostatic valves are factory set to a safe maximum temperature of 48°C. If required, the maximum outlet temperature can be adjusted by following the procedure below:

- 1 Set the temperature lever to the mid blend (6 o'clock) position.
- 2 Remove the temperature control lever and grub screw using the hexagonal key provided and set aside.
- 3 Insert the hexagonal key into the temperature control knob and loosen the grub screw. Remove the control knob from the valve and set aside.
- 4 Remove the maximum temperature stop ring and reposition in the desired location.
- 5 Replace the temperature control knob so the lever fixing point is in the mid blend position.
- 6 Turn the valve on and check the maximum temperature using a digital thermometer. If any adjustment is required, repeat steps 4 and 5 above until the desired maximum temperature has been reached.
- 7 Re-assemble the valve in the reverse order of the above procedure.

Trouble shooting guide

Symptom	Possible cause	Action
Water output is either all hot or all cold, or cold only	Reversed inlet supplies	Check that the supplies correspond with the inlet markings
Water output is not hot enough	The temperature of the hot water cylinder is too low	The cylinder temperature should be at least 15°C hotter than the blend
	Water flow through the hot water appliance is too fast	Check the flow rate recommendations with the heater manufacturer
	Water flow through the hot water appliance is too fast (Bath/shower mixers on combination boiler systems)	Adjust the flow control knob on the mixer valve to reduce flow until a comfortable showering or bathing temperature is achieved
Flow rate is poor and water temperature is low	Airlock in the hot water supply	Check that the pipe work is laid out in accordance with correct practices, paying particular attention to potential air-traps
Water temperature swings regularly between hot and cold	Cold water pressure is too high	If the static water pressure exceeds 10 bar, install a pressure reducing valve (PRV) in accordance with the installation guide
	The flow regulator, or the correct flow regulator has not been fitted (Combi boiler systems)	Fit the relevant flow regulator
Poor flow rate	Twisted hose Debris in shower head Debris in filters Debris in hot inlet flow regulator (combi boiler systems)	Check for debris and clear as necessary

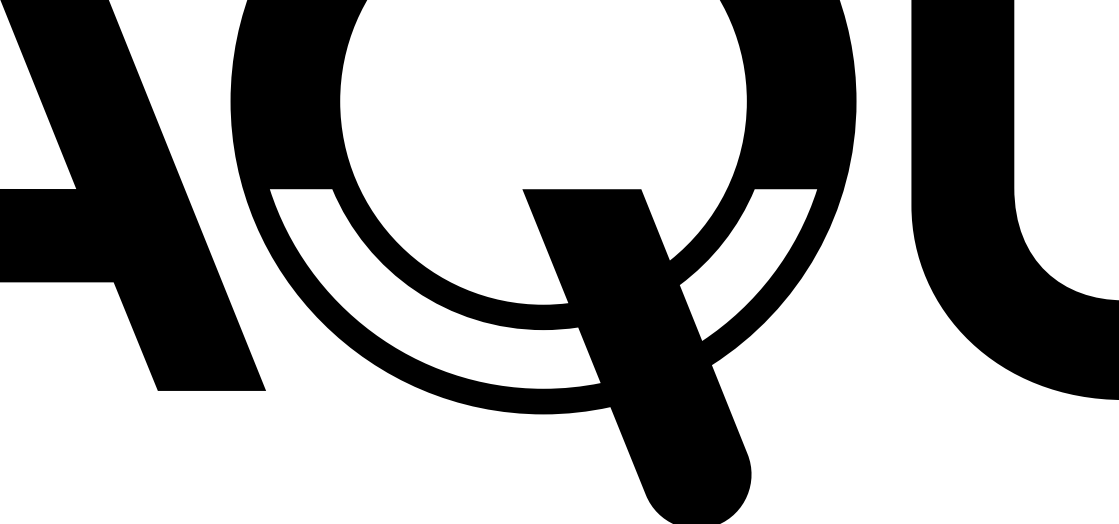

AQUALISA

Aqualisa Products Limited
The Flyer's Way
Westerham Kent TN16 1DE

Customer helpline: 01959 560010
Brochure Hotline: 0800 652 3669
Website: www.aqualisa.co.uk
Email: enquiries@aqualisa.co.uk

Republic of Ireland
Sales enquiries: 01-864-3363
Service enquiries: 01-844-3212



Part No.660101 Issue 01 Jan 11

Please note that calls may be recorded for training and quality purposes

The company reserves the right to alter, change or modify the product specifications without prior warning

© Registered Trademark Aqualisa Products Limited