

INSTALLATION INSTRUCTIONS

SE910 SE913 SE920 SE921

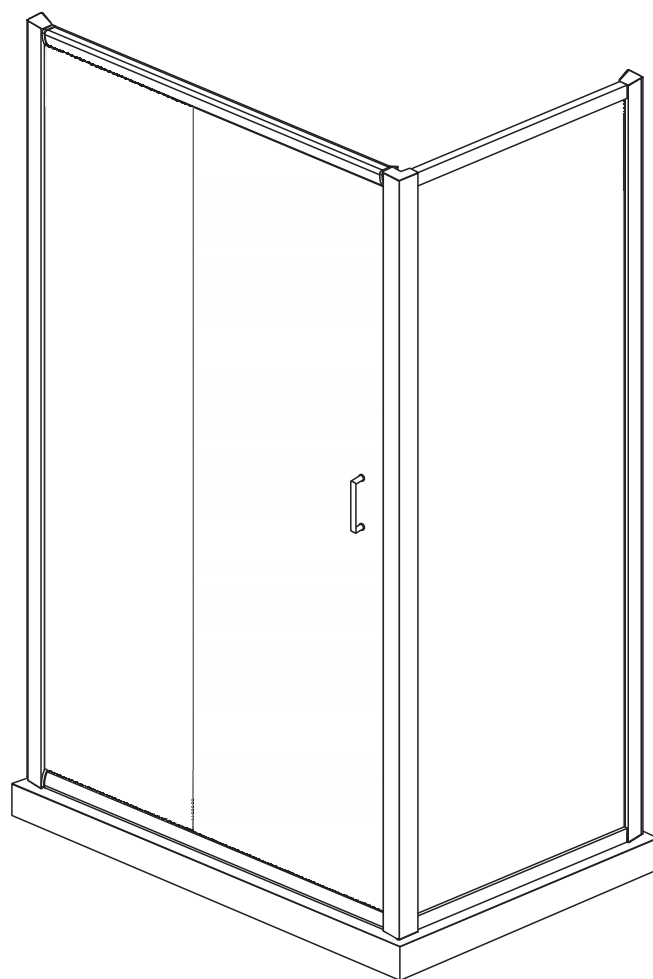

◆ General Information

Please inspect the product immediately upon receipt for transit damage, missing packs/parts or manufacturing fault. Damage reported later cannot be accepted. Please handle the product with care avoiding knocks and shock loading to all sides and edges of the glass.

Notes: Safety glass can not be re-worked.

Please read these instructions carefully before start of installation.

Special care should be taken when drilling walls to avoid hidden pipes or electrical cables.

Note: This product is heavy and may require two people to install.

Aftercare instructions

After use, your shower should be cleaned with soap and water. This is particularly important in hard water districts where insoluble lime salts may be deposited and allowed to build up.

Cleaners of a gritty or abrasive nature should not be used. Care should be taken to avoid contact with strong chemicals such as organic solvents and strippers.

Glass cleaners can be used but with caution, if in doubt contact the manufacturer of the cleaner in question.

Please keep these instructions for aftercare and customer service details.



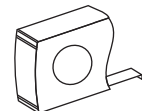
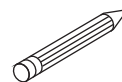
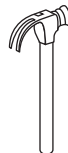
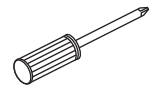
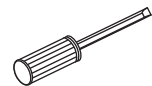
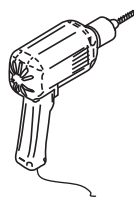
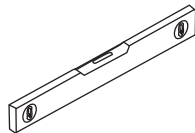
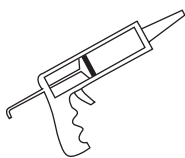







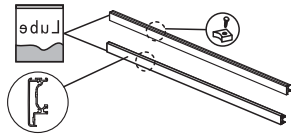

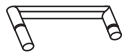

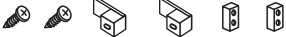
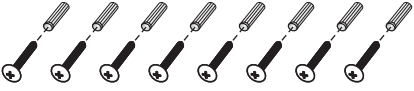

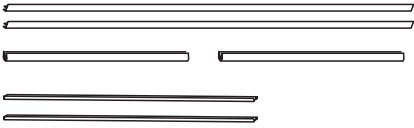
Tools Required

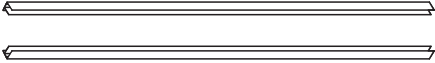

This product is heavy and may require two people to install.

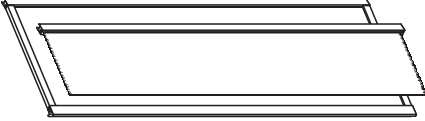

◆ Box Contents:

<p>[1] 1xTop Horizontal Rail. 1xBottom Horizontal Rail 8xFlat Screws M4x35. 1xLube.</p>	→		
<p>[2] 1xInstallation Instruction.</p>	→		
<p>[3] 1xHandle Set .</p>	→		
<p>[4] 5xProfile Covers.</p>	→		
<p>[5] 8xProfile Covers.</p>	→		
<p>[6] 2xBumper Blocks 2xScrews M4x16. 2xClips.</p>	→		
<p>[7] 8xWall Plugs. 8xFlat Screws M4x35.</p>	→		
<p>[8] 12xScrews M4x10.</p>	→		
<p>[9] 2xWater Deflectors. 2xDeflectors. 2xDeflectors .</p>	→		
<p>[10] 1xMagnetic Seal .</p>	→		
<p>[11] 2xWall Posts.</p>	→		
<p>[12] 1xPost .</p>	→		
<p>[13] 2xProfile Connectors. 1xProfile Connector.</p>	→		
<p>[14] 2xFixed Panels.</p>	→		
<p>[15] 1xDoor Panel. 2xTop Rollers. 2xBottom Hooks</p>	→		

◆ Assembly Drawing

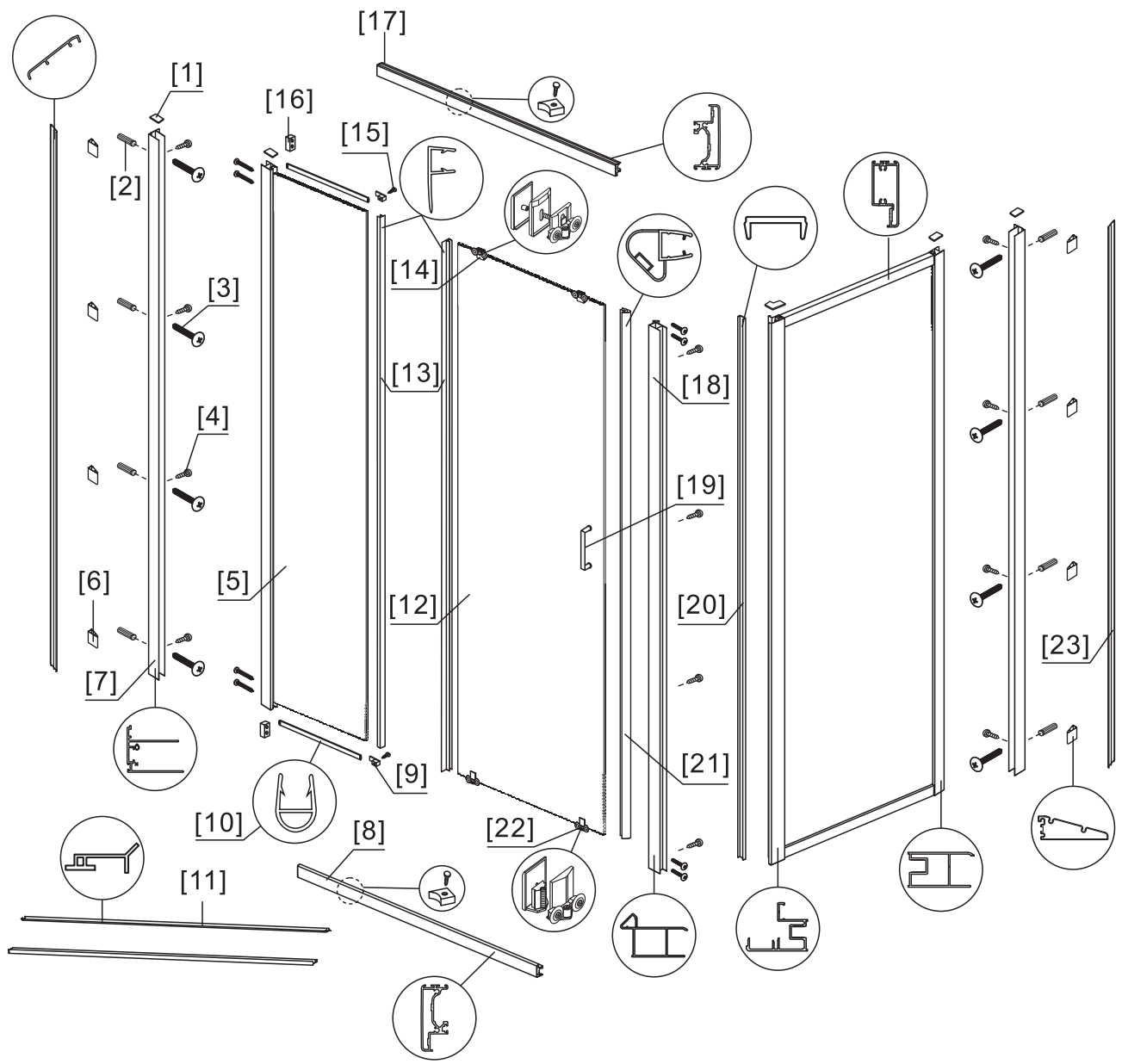

- [1] 5xProfile Covers
- [2] 8xWall Plugs
- [3] 16xFlat Screws M4x35
- [4] 12xScrews M4x10
- [5] 2xFixed Panels
- [6] 8xProfile Covers
- [7] 2xWall Posts
- [8] 1xBottom Horizontal Rail
- [9] 2xBumper Blocks
- [10] 2xWater Deflectors
- [11] 2xDeflectors

- [12] 1xDoor Panel
- [13] 2xWater Deflectors
- [14] 2xTop Rollers
- [15] 2xScrews M4x16
- [16] 2xClips
- [17] 1xTop Horizontal Rail
- [18] 1xPost
- [19] 1xHandle Set
- [20] 1xProfile Connector
- [21] 1xMagnetic Seal
- [22] 2xBottom Hooks
- [23] 2xProfile Connectors

◆ Installation Steps

Step 1

Please Note:- Shower Tray Must Not Be Recessed Into the Walls by More Than 15mm. Anything More Than This May Affect The Alignment and Adjustment of the Enclosure on the Tray

No Drilling of Tiles Should Take Place Until the Enclosure Has Been Lifted Into Place to Ensure Correct Alignment and Fitting to The Tray

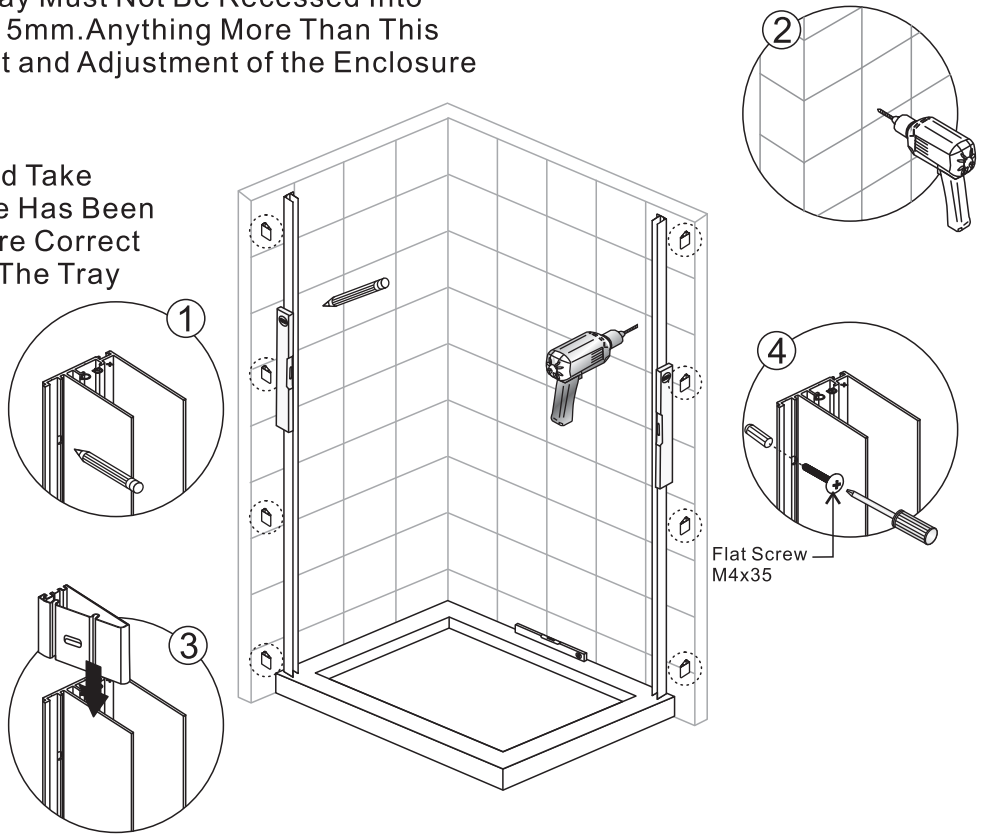

Step 2

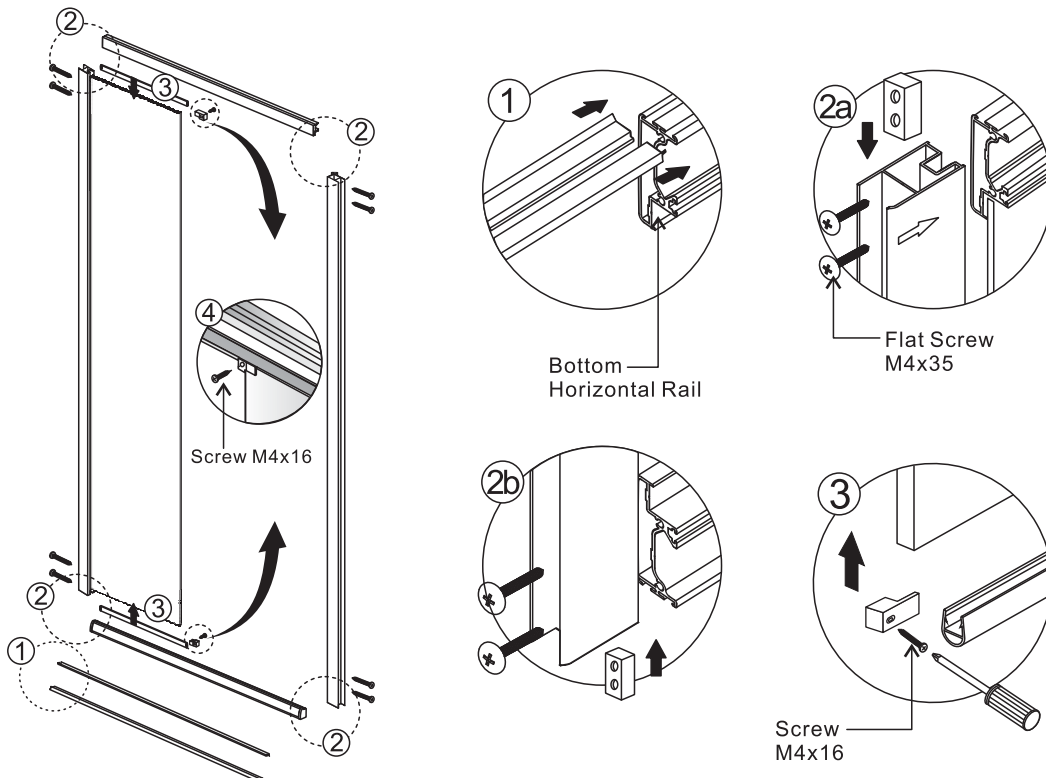

Step 3

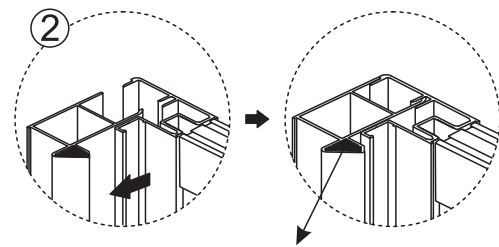
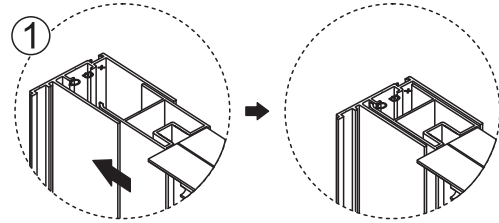
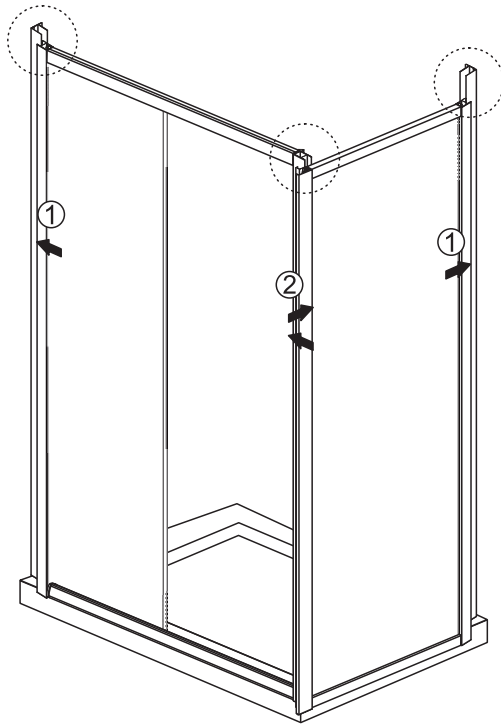

Magnetic Seal

Step 4

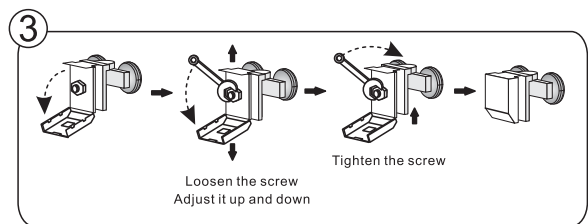
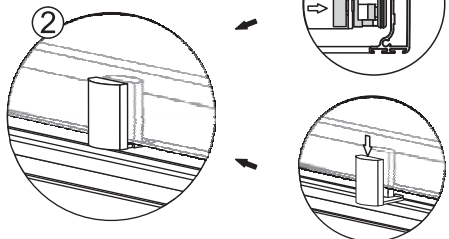
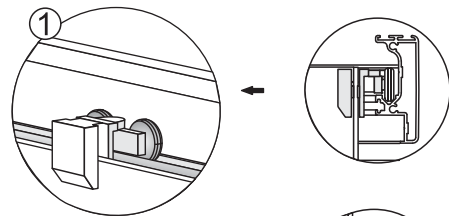
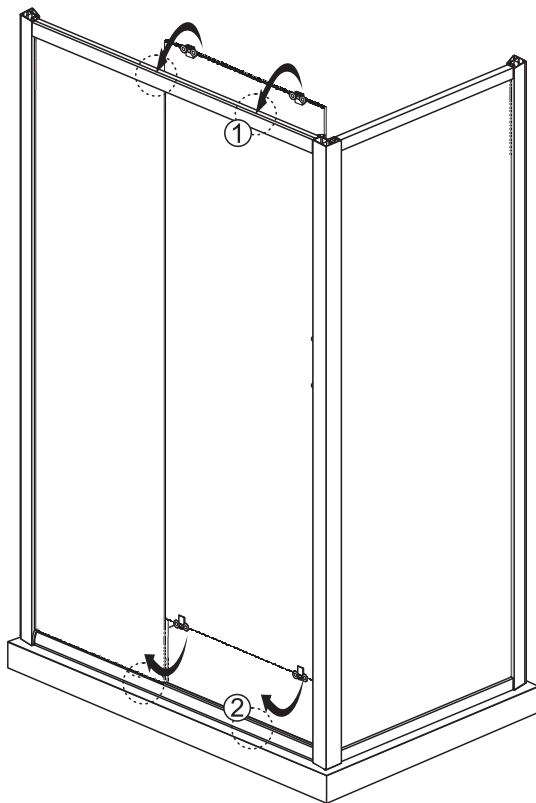

Step 5

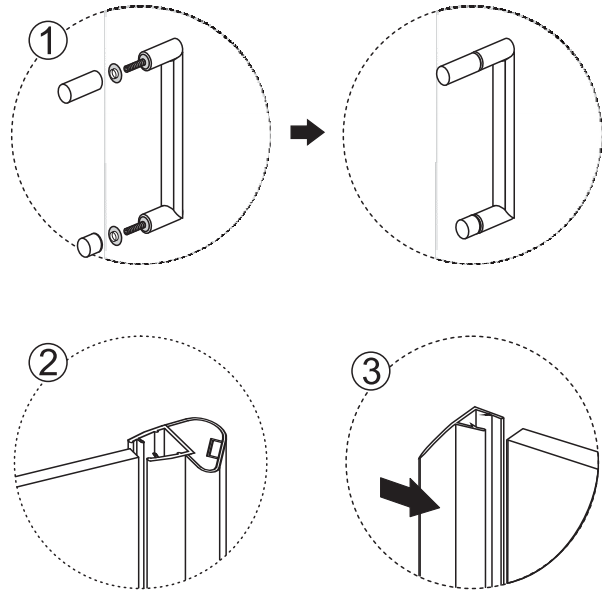
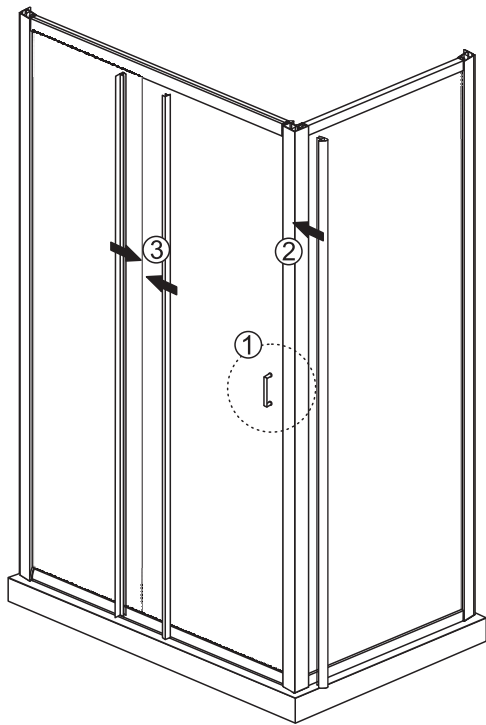

Adjust enclosure to hold top balane, make vertical posts upright, and keep the whole balanceable. The door should be push-and-pulled smoothly.

Step 6

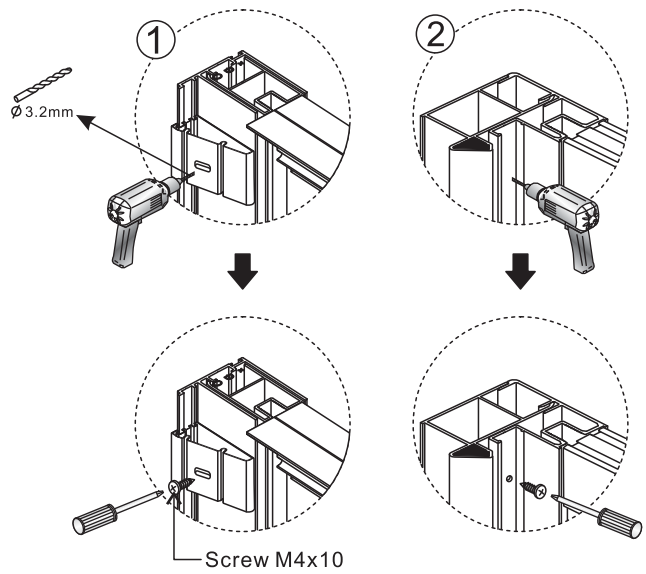
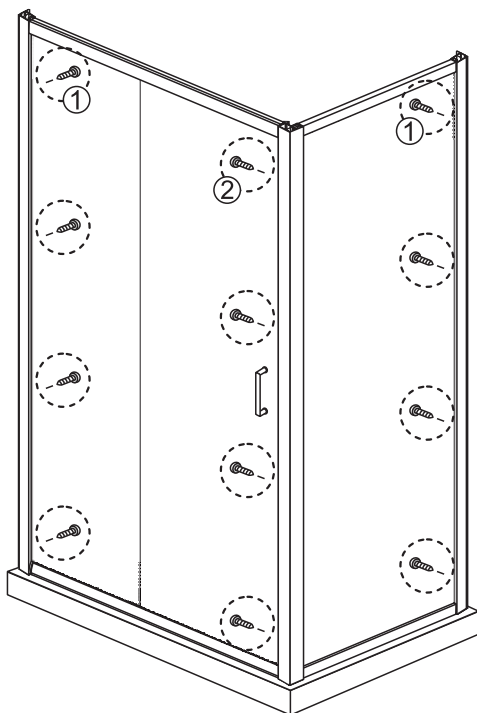

View from inside

Step 7

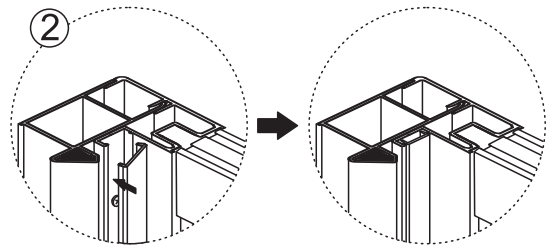
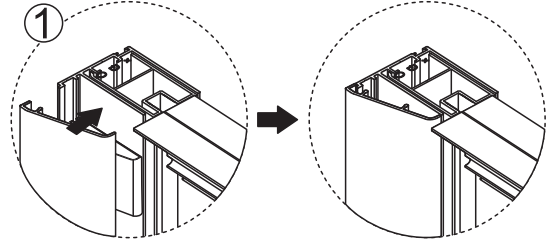
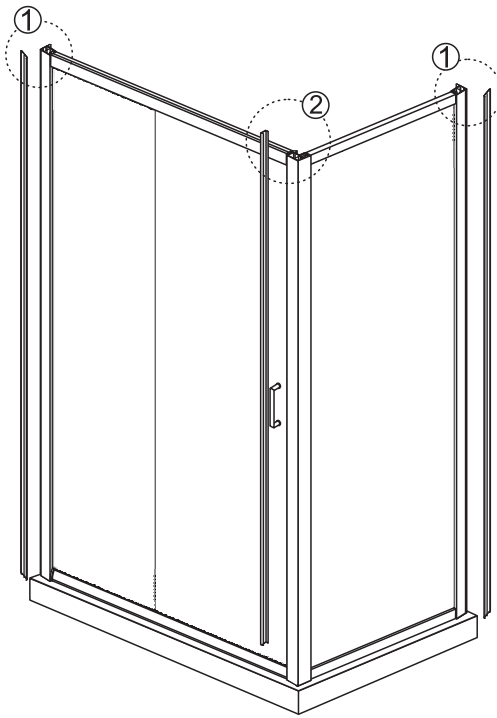

View from inside

Step 8

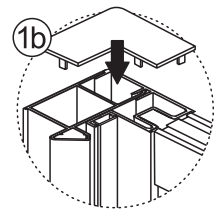
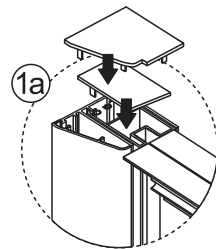
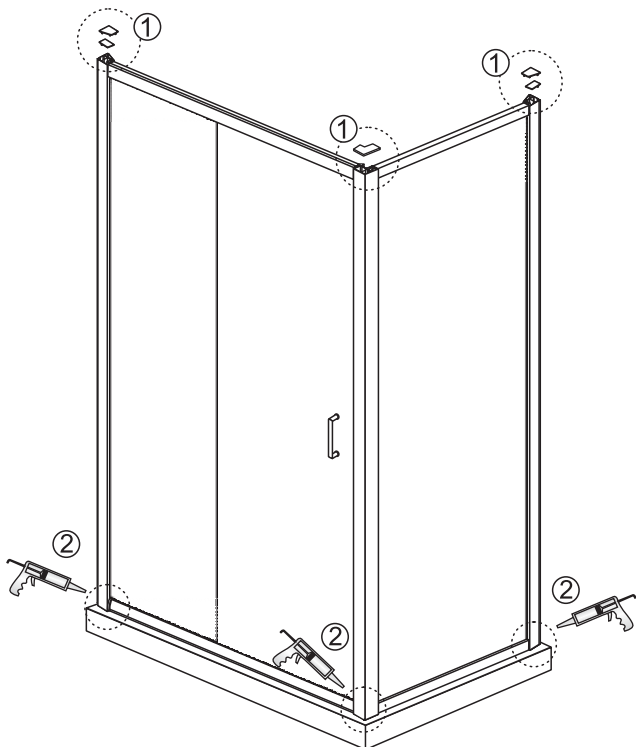

View from inside



Allow 24 hours for silicone to dry before use.

A High Grade Silicone Sealant Should Be Used and Applied Externally As And Where Required Between the Glass and Aluminium Frame and Between the Aluminium Frame and the Tiled Walls/Shower Tray