

---

**Pre-installation data sheet**      for baths and whirltubs

## Index

---

Index .....	2
Important planning tips for bathtubs .....	3
Important planning tips for whirltubs .....	4
Maintenance openings .....	6
Data sheets for baths and whirltubs .....	10

## Important planning tips for bathtubs

### Installation location

- Check width of doors. Make sure that there will be no problems bringing the tub into the bathroom.
- There must not be any underfloor heating under the tub.
- The floor must be absolutely flat and horizontal.
- Install tubs **after** the tiles. (Top edge of finished floor)
- **Tolerances for acrylic:** As a result of the manufacturing process, deviations from the nominal dimensions may occur within the limits specified in the DIN 198 standard. Please take this into account in your planning.

### Maintenance openings and air supply

#### Tiling the tub

- The following maintenance openings must be provided:
  - Drain and overflow fittings 200 x 200 mm
  - Control for coloured LED light/sound (optional) 200 x 200 mm maintenance opening at the foot end.
- Bathtub with coloured LED light: provide an opening in the panel for the air supply with an area of approximately 15 cm<sup>2</sup> (e.g. 3 x 5 cm or 2 x 7.5 cm).

#### Tub with removable panelling from Duravit

- It must be possible to remove the panelling for maintenance purposes. Your plans should therefore include clearance in front of the panelling.
- Provide for a gap of min. 2 mm between the floor and around the bathtub for the necessary air supply. This gap must remain unobstructed.

#### Tub with integrated/ seamless panel

- It must be possible to remove the tub for maintenance purposes. Your plans should therefore include clearance in front of the tub.
- Provide for a gap of min. 2 mm between the floor and around the bathtub for the necessary air supply. This gap must remain unobstructed.

### Water installation

All work associated with the water connection may only be undertaken by a licensed plumber. The installation must be in accordance with country-specific standards and local regulations.

#### NOTICE

If the tray has a base inlet, a pipe interrupt must always be installed on-site. (DIN EN 1717)

> See installation diagram. (Page 4)

### Water connection

- Connections for the water supply and drains must be in compliance with the currently valid standards and local regulations.
- Set coupling bush flush to mounting surface.

### Electrical installation, bathtubs for coloured LED light/sound/white LED light under the edge of the tub



All work associated with the electrical connection may only be undertaken by a licensed electrician. The installation must comply with country-specific standards, local regulations and low-voltage guidelines.

### Electrical data

#### Power supply

- Sound:
  - #791851 00 0 00 0000: 220-240V AC, 50/60Hz, 80W
- Coloured LED light with remote control for bathtubs
  - #790840 00 0 XX00: 110-240V AC, 50/60Hz, 30W
- Coloured LED light with remote control for Blue Moon bathtub
  - #790846 00 0 XX00: 110-240V AC, 50/60Hz, 60W
- White LED light under the edge of the tub
  - #791847 00 0 0000,
  - #791848 00 0 0000,
  - #791849 00 0 0000: 220-240V AC, 50/60Hz, 50W

#### Circuit breaker

I<sub>N</sub> = 16 A

#### RCCB

I<sub>ΔN</sub> ≤ 30 mA

### Pre-installation

- > Lay a fixed feed cable for power supply:
  - install separate circuit breaker and residual-current circuit breaker (RCCB) upstream
  - connect all pole disconnector mains switch upstream located outside specified protection zones (0 - 2)
  - leave 3000 mm of feed cable exposed
- > Lay equipotential bonding cables:
  - leave 3000 mm of cable exposed

### Protection zones

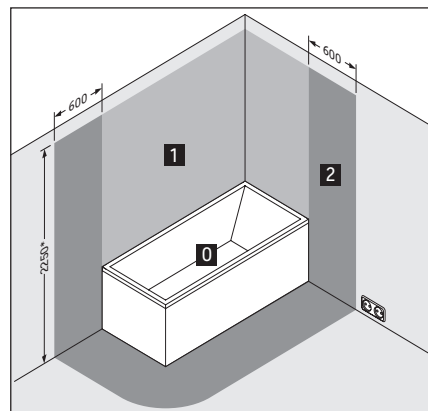

\* or the height of the highest fixed-location shower head/water outlet, whichever is higher

## Important planning tips for whirltubs

### Transport

- > Wear suitable protective clothing.
  - > Keep the tub only at the marked points. Not at the whirlsystem.
  - > Avoid collisions.
- Improper transport could cause leaks.

### Installation location

- Check width of doors. Make sure that there will be no problems bringing the tub into the bathroom.
- There must not be any underfloor heating under the tub.
- The floor must be absolutely flat and horizontal.
- Install tubs **after** the tiles. (Top edge of finished floor)
- Depending on the combination of tub and whirltub system it is possible that system components may protrude beyond the edge of the tub. We therefore recommend installation in a supporting frame.
- **Tolerances for bathtubs:** As a result of the manufacturing process, deviations from the nominal dimensions may occur within the limits specified in the DIN 198 standard. Please take this into account in your planning.

### Maintenance openings and air supply

#### NOTICE

Due to the improved revision possibility installation is recommended with a removable panel.

#### Tiling the tub

- The following maintenance openings must be provided:
  - Drain and overflow fittings           200 x 200 mm
  - Equipment                                 500 x 500 mm
- For locations, please see the section on "Maintenance openings".
- Provide an opening in the panel for the air supply with an effective area of approximately 15 cm<sup>2</sup> (e.g. 3 x 5 cm or 2 x 7.5 cm).

#### Tub with removable panelling from Duravit

- It must be possible to remove the panelling for maintenance purposes. Your plans should therefore include clearance in front of the panelling.
- For the air supply is an opening pre-installed in the panel or is to provide a gap of min. 2 mm between the floor and around the bathtub. This opening must remain unobstructed.

#### Tub with integrated/ seamless panel

- It must be possible to remove the tub for maintenance purposes. Your plans should therefore include clearance in front of the tub.
- For the air supply is an opening pre-installed in the panel or is to provide a gap of min. 2 mm between the floor and around the bathtub. This opening must remain unobstructed.

### Water installation

All work associated with the water connection may only be undertaken by a licensed plumber. The installation must be in accordance with country-specific standards and local regulations.

#### NOTICE

If the tray has a base inlet, a pipe interrupt must always be installed on-site. (DIN EN 1717)

- > See installation diagram.

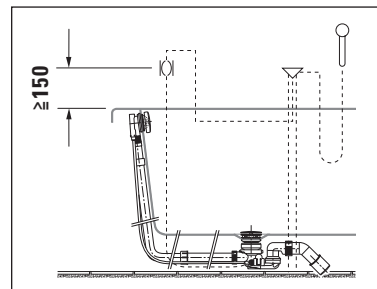

### Water connection

- Connections for the water supply and drains must be in compliance with the currently valid standards and local regulations.
- Set coupling bush flush to mounting surface.

## Electrical installation for whirltubs

 All work associated with the electrical connection may only be undertaken by a licensed electrician. The installation must comply with country-specific standards, local regulations and low-voltage guidelines.

### Electrical data

Whirl system	Rated power with standard equipment	Max. rated power, fully-equipped
Air-System (# 760XXX XX X AS 00XX)	0.76 kW	0.85 kW
Air-System (DuraSolid) (# 760XXX XX X AS 00XX)	0,58 kW	0,58 kW
Jet Project (# 760XXX XX X JP 10XX)	0,66 kW	0,66 kW
Jet-System (# 760XXX XX X JS 10XX)	0.59 kW	0.67 kW
Combi-System P (# 760XXX XX X CP 10XX)	1.89 kW	1.98 kW
Combi-System E (# 760XXX XX X CE 10XX)	1.91 kW	2.96 kW
Combi-System L (# 760XXX XX X CL 10XX)	1,59 kW	2,64 kW
Jet-System E (# 760XXX XX X JE 10XX)	1.14 kW	2.20 kW

### Power supply

# 76XXXX XX X XX XXX0: 220-240V AC, 50Hz  
 # 76XXXX XX X XX XXX6: 220-240V AC, 60Hz

**Circuit breaker**  $I_N = 16 \text{ A}$

**RCCB**  $I_{\Delta N} \leq 30 \text{ mA}$

### Pre-installation

- > Lay a fixed feed cable for power supply:
  - install separate circuit breaker and residual-current circuit breaker (RCCB) upstream
  - connect all pole disconnector mains switch upstream located outside specified protection zones (0 - 2)
  - leave 3000 mm of feed cable exposed
- > Lay equipotential bonding cables:
  - leave 3000 mm of cable exposed

## Protection zones

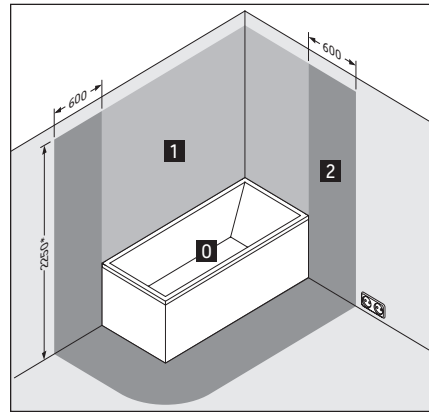

\* or the height of the highest fixed-location shower head/water outlet, whichever is higher

## Maintenance openings

### Revisability

The whirltub should be installed that way, that all important components (pump, blower and control panel) are still accessible. When an whirltub is equipped with a panel, this should be accessible and removable.

### Locations of the whirltub system components

The illustrations show the standard configuration for the components of the whirl system\* with the location of the operating unit. The back massage is located at the head end (depending on the whirl system). Custom-made designs available on request. In such cases we will require a drawing showing the desired layout. Duravit will confirm whether the desired layout can be implemented.

#### 2x3

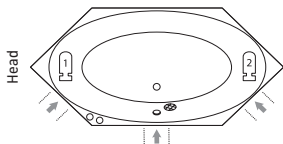

# 760023, # 760024

#### 2nd floor

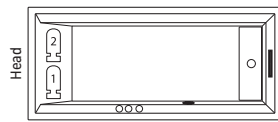

# 760074, # 760075

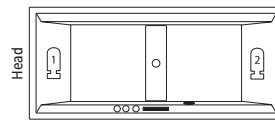

# 760076, # 760160, # 760161

#### Blue Moon

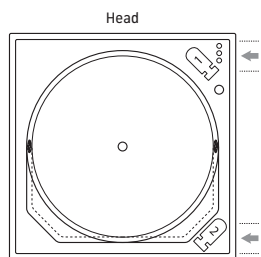

# 760143

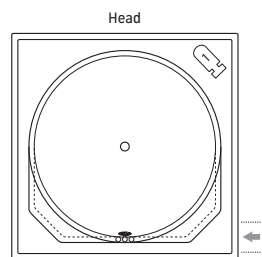

# 760402

#### Cape Cod

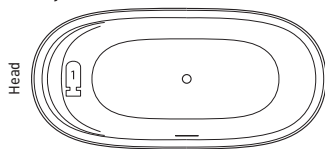

# 760330

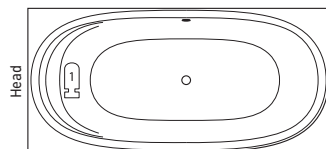

# 760362

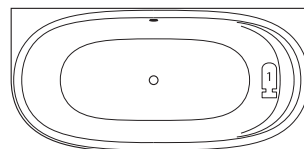

# 760363

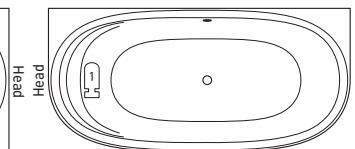

# 760364

#### Darling New

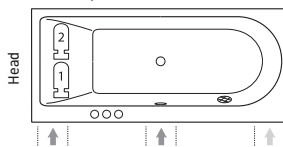

# 760238, # 760240, # 760242

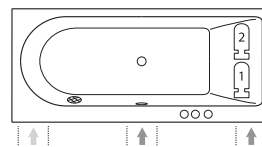

# 760239, # 760241, # 760243

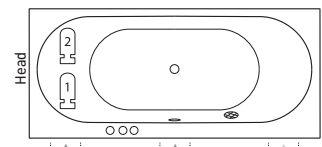

# 760244, # 760245

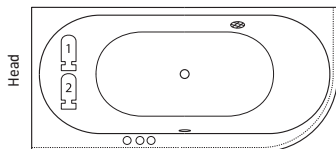

# 760246

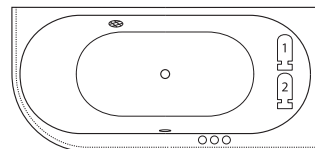

# 760247

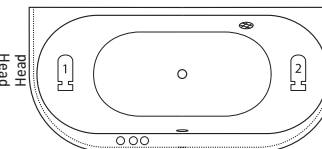

# 760248

#### Daro

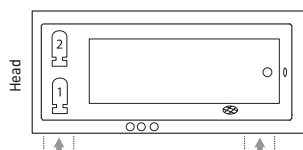

# 760027, # 760141

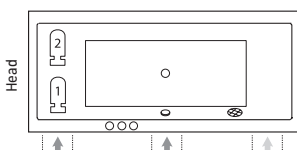

# 760028

\* Please note that depending on the combination of tub and whirltub system it is possible that system components may protrude beyond the edge of the tub. We therefore recommend installation in a supporting frame / Air-System, Air-System Cape Cod, Jet Project, Jet-System, Combi-System P, Combi-System E, Combi-System L, Jet-System E and Durapearl-System: 76...

**D-Code**

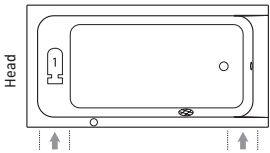

# 760095, # 760096,  
# 760098, # 760100

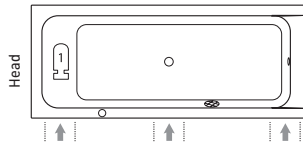

# 760097, # 760099

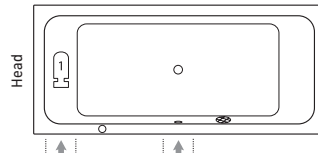

# 760101

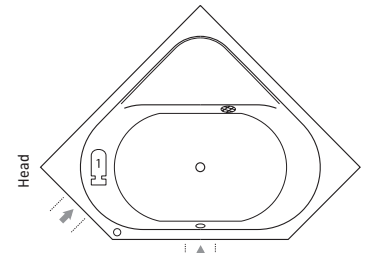

# 760137

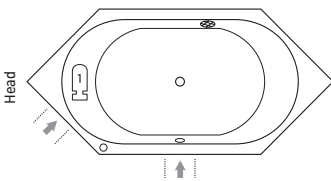

# 760138

**DuraStyle**

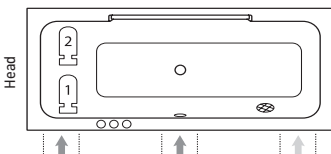

# 760292, # 760294, # 760296

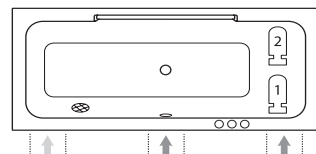

# 760293, # 760295, # 760297

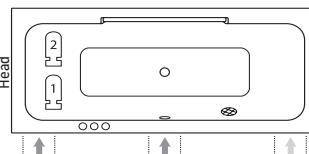

# 760298, # 760299

**DuraSquare**

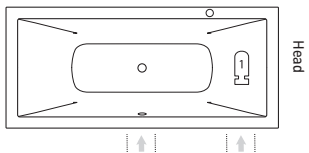

# 760426

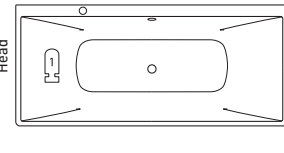

# 760427

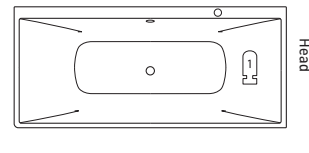

# 760428, # 760429

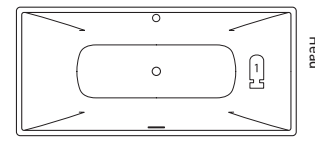

# 760430

**Happy D.2**

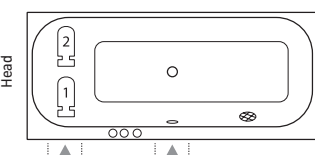

# 760308, # 760310, # 760312

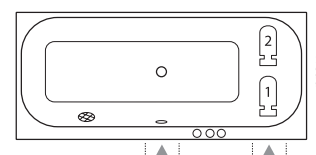

# 760309, # 760311, # 760313

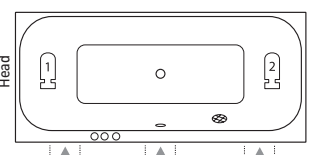

# 760314, # 760315

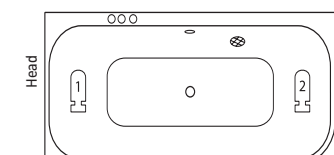

# 760316

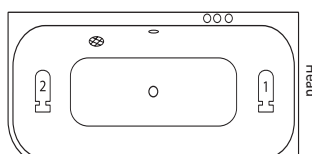

# 760317

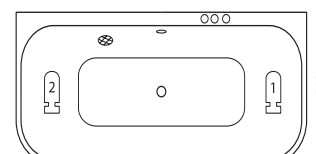

# 760318

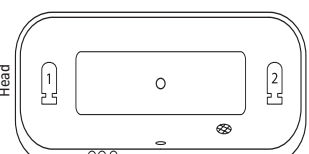

# 760319

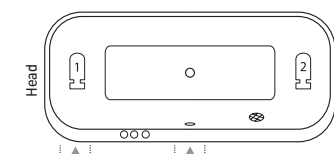

# 760320

**Luv**

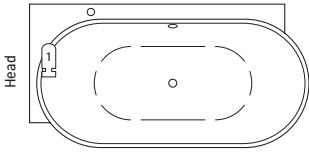

# 760431

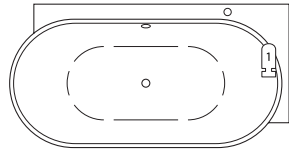

# 760432

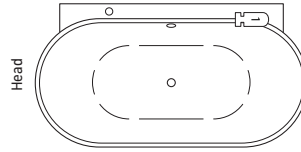

# 760433

**P3 Comforts**

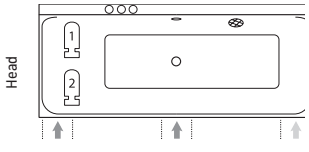

# 760371, # 760373, # 760375

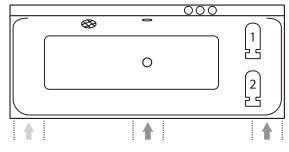

# 760372, # 760374, # 760376

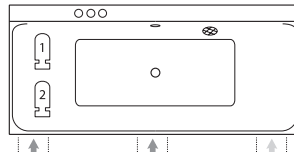

# 760377, # 760378

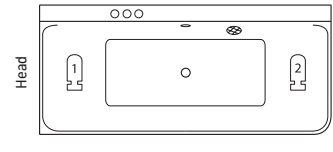

# 760379

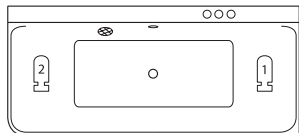

# 760380

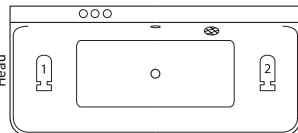

# 760381

**Paiova**

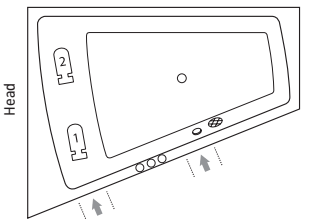

# 760212, # 760218  
# 760214, # 760220  
# 760216, # 760222

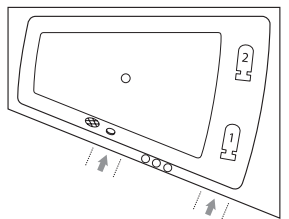

# 760213, # 760219  
# 760215, # 760221  
# 760217, # 760223

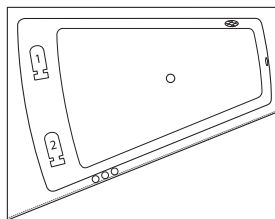

# 760264, # 760266, # 760268

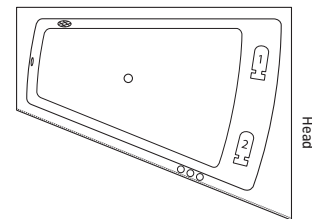

# 760265, # 760267, # 760269

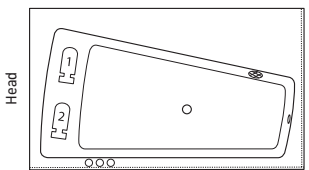

# 760270

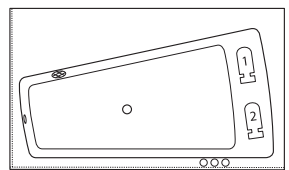

# 760271

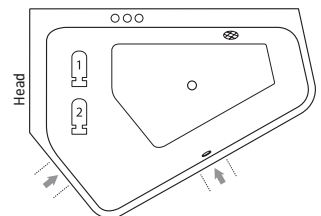

# 760390, # 760392

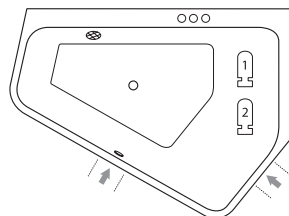

# 760391, # 760393

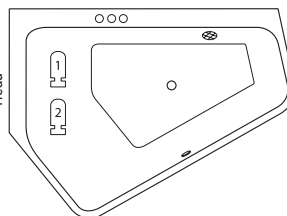

# 760394, # 760396

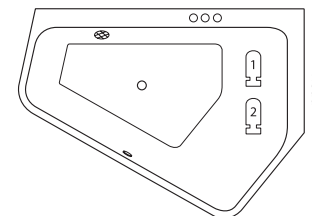

# 760395, # 760397

Air-System, Air-System Cape Cod, Jet Project, Jet-System, Combi-System P, Combi-System E, Combi-System L, Jet-System E and Durapearl-System: 76...



### Starck

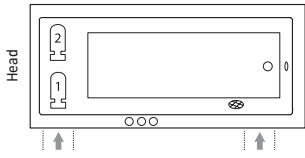

# 760050, # 760333, # 760334,  
# 760335, # 760336, # 760337

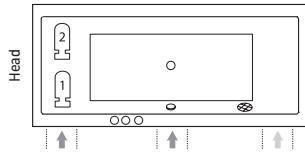

# 760052, # 760338, # 760339,  
# 760340, # 760341

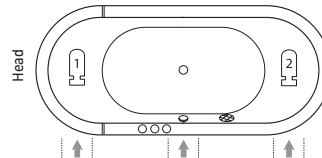

# 760009

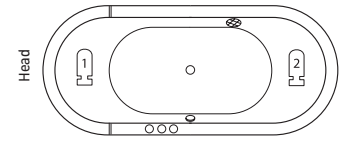

# 760010

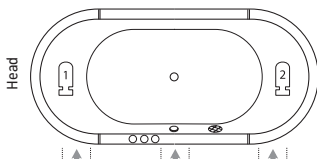

# 760011

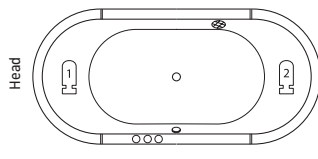

# 760012

### Vero

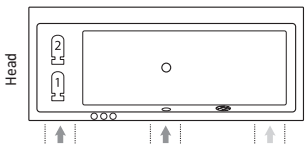

# 760133

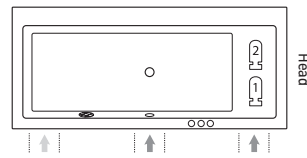

# 760134

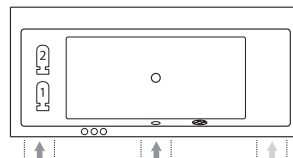

# 760135, # 760136

### Vero Air

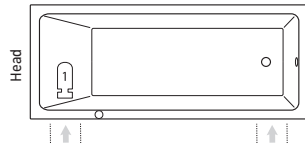

# 760411, # 760412

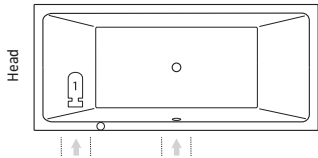

# 760413, # 760414

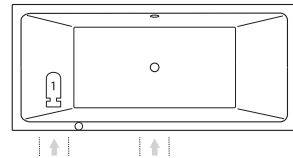

# 760415, # 760416, # 760417,  
# 760418

### Legend



Unit 1



Unit 2\*



Operating unit\*\*



Intake  
opening



Pull knob



Tap module



Required mainte-  
nance openings



Required mainte-  
nance openings\*\*\*

\* Only Combi-Systems / \*\* The number of operating elements is based on the whirltub system and the additional modules selected / \*\*\* Only necessary for Combi-System E/L in combination with sound and/or coloured LED light / Air-System, Air-System Cape Cod, Jet Project, Jet-System, Combi-System P, Combi-System E, Combi-System L, Jet-System E and Durapearl-System: 76...

## Data sheets for baths and whirltubs

---

# Pre-installation Luv # 7X0431

1850 x 950 x 610

Design by Cecilie Manz

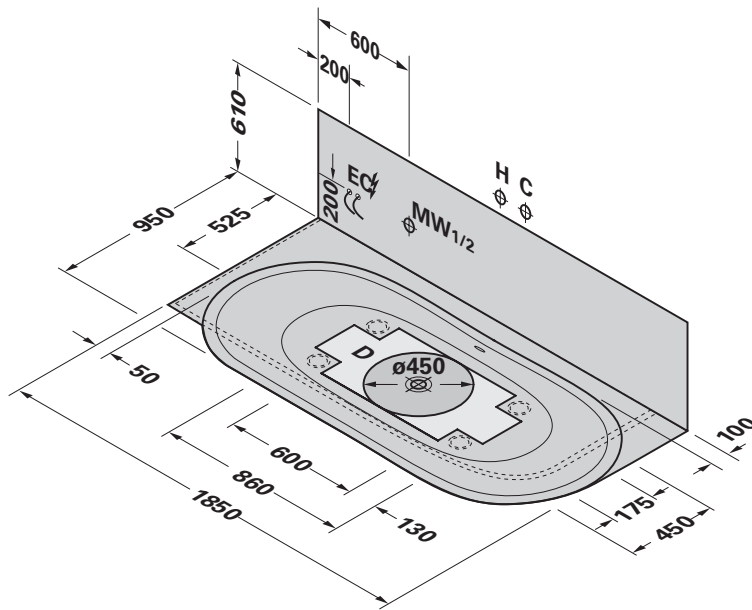

- H** Hot water connection
- C** Cold water connection
- D** Drain connection
- MW1** Mixed water connection for waste and overflow with water inlet
- MW2** Mixed water connection for waste and overflow with base inlet
- EC** Electricity connection

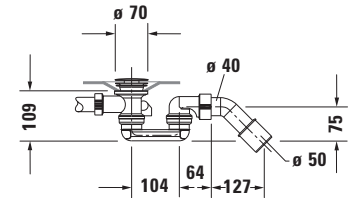

Siphon for bathtub # 700431

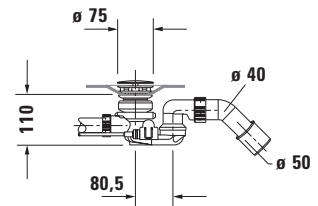

Siphon with base inlet for bathtub # 700431

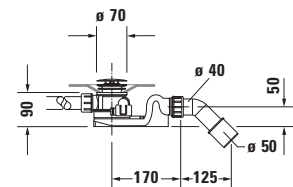

Siphon for whirltub # 760431

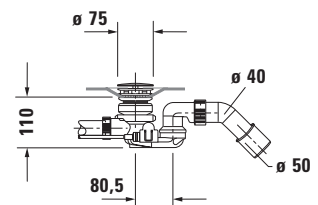

Siphon with base inlet for whirltub # 760431

## Technical specifications

Net weight kg	Floor load kg/m <sup>2</sup>	Shipping weight kg	Shipping dimensions l x w x h (cm)	Water inlet OD, ID	Whirlsystem	Model-No.
105,0	237	169,0	200 x 100 x 70	3/4", 1/2"		700431 00 0 00 0000
115,0	243	179,0	200 x 100 x 70	3/4"	Air-System	760431 00 0 AS 0000

# Pre-installation Luv # 7X0432

└ 1850 x 950 x 610 ┘

Design by Cecilie Manz

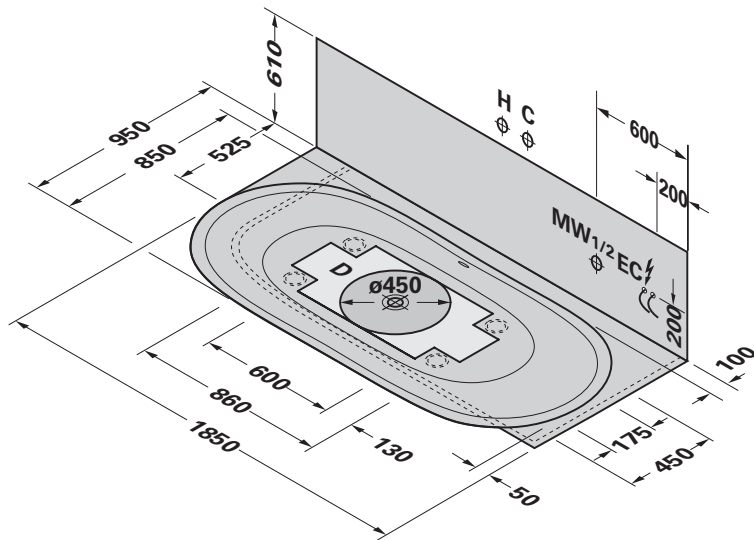

- H Hot water connection
- C Cold water connection
- D Drain connection
- MW1 Mixed water connection for waste and overflow with water inlet
- MW2 Mixed water connection for waste and overflow with base inlet
- EC Electricity connection

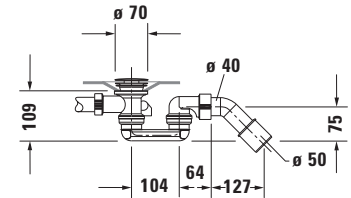

Siphon for bathtub # 700432

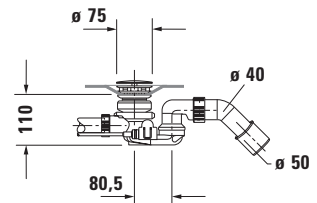

Siphon with base inlet for bathtub # 700432

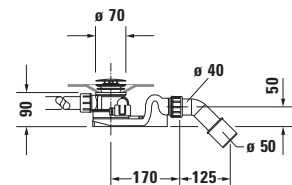

Siphon for whirltub # 760432

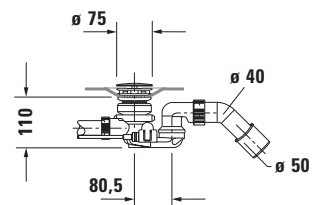

Siphon with base inlet for whirltub # 760432

## Technical specifications

Net weight kg	Floor load kg/m <sup>2</sup>	Shipping weight kg	Shipping dimensions l x w x h (cm)	Water inlet OD, ID	Whirlsystem	Model-No.
105,0	237	169,0	200 x 100 x 70	3/4", 1/2"		700432 00 0 00 0000
115,0	243	179,0	200 x 100 x 70	3/4"	Air-System	760432 00 0 AS 0000

# Pre-installation Luv # 7X0433

⊔ 1800 x 950 x 610 ⊔

Design by Cecilie Manz

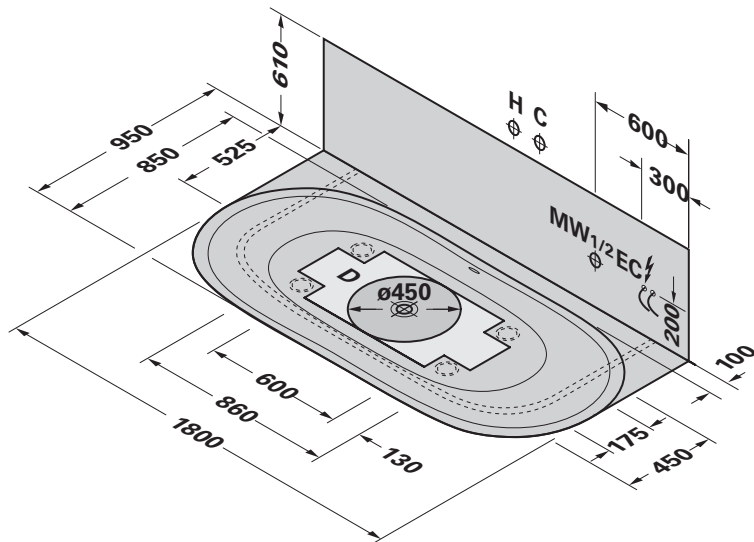

- H** Hot water connection
- C** Cold water connection
- D** Drain connection
- MW1** Mixed water connection for waste and overflow with water inlet
- MW2** Mixed water connection for waste and overflow with base inlet
- EC** Electricity connection

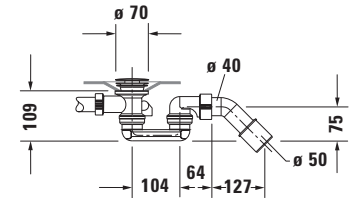

Siphon for bathtub # 700433

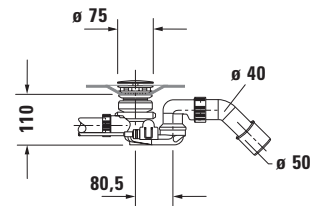

Siphon with base inlet for bathtub # 700433

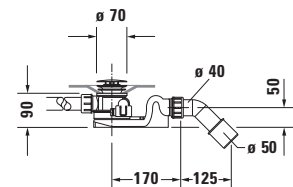

Siphon for whirltub # 760433

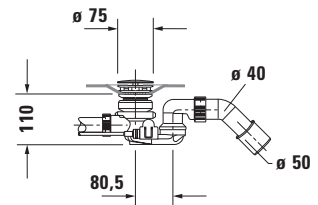

Siphon with base inlet for whirltub # 760433

## Technical specifications

Net weight kg	Floor load kg/m <sup>2</sup>	Shipping weight kg	Shipping dimensions l x w x h (cm)	Water inlet OD, ID	Whirlsystem	Model-No.
110,0	247	174,0	200 x 100 x 70	3/4", 1/2"		700433 00 0 00 0000
120,0	253	184,0	200 x 100 x 70	3/4"	Air-System	760433 00 0 AS 0000

# Pre-installation Luv # 700434

↳ 1800 x 850 x 610 ‹

Design by Cecilie Manz

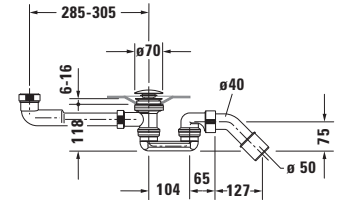
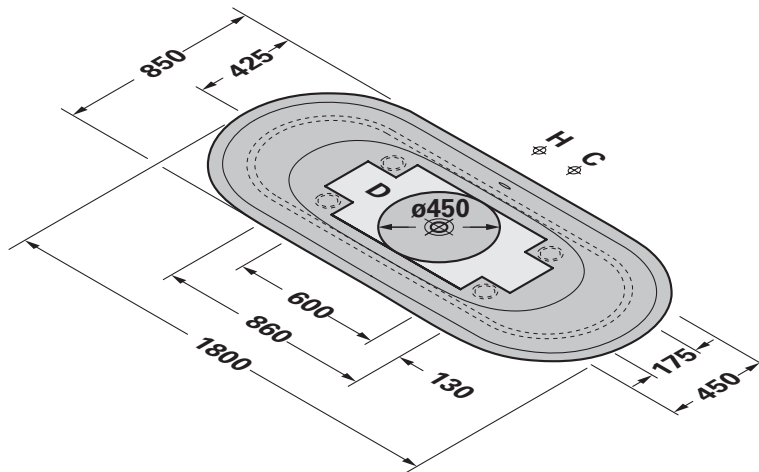

Siphon for bathtub # 700434

- H Hot water connection
- C Cold water connection
- D Drain connection

### Technical specifications

Net weight kg	Floor load kg/m <sup>2</sup>	Shipping weight kg	Shipping dimensions l x w x h (cm)	Water inlet OD, ID	Whirlsystem	Model-No.
114,0	278	178,0	200 x 100 x 70	-		700434 00 0 00 0000