

**GEBERIT AQUACLEAN TUMA
COMFORT**

GEBERIT

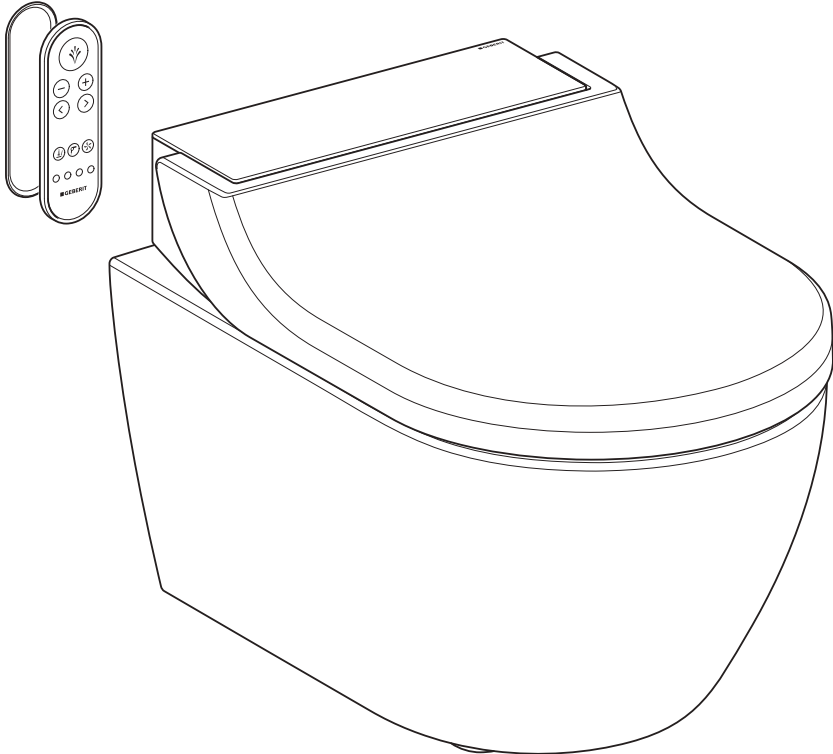

USER MANUAL

Table of contents

For your safety	5
Who is this product suitable for?	5
How is this product used?	5
What should you avoid?	5
Misuse	5
General safety notes	6
Overview of the alert levels and symbols in these instructions	8
Overview of symbols on the product	8
Register your device	9
Warranty registration	9
Getting to know your device	10
About Geberit AquaClean devices	10
Functional overview	10
Duration of shower procedures	10
Duration of the drying procedure	10
The device at a glance	11
Switching the device on and off	13
Operating concept	15
About the operating concept	15
Front side of the remote control	15
Rear side of the remote control	16
Lateral control panel	16
Special assignment of the buttons	17
Geberit AquaClean app	18
How to use the device	19
Your device settings	19
Additional device settings in the Geberit AquaClean app	19
Adjusting the shower procedure to your personal needs	20
Switch odour extraction run-on function on and off	21
Switch off the continuous flow heater	21
Switch WC seat heating on and off	22
Use the anal shower	22
Set the spray intensity	23
Set the spray arm position	23
Switching the oscillating motion of the anal shower on and off	24
Use the Lady shower	24
Switching the oscillating motion of the Lady shower on and off	25
Use the dryer	25
Quick saving of user profiles	26
Quick saving of the basic profile	26
Saving your personal user profile in the Geberit AquaClean app	27
What happens after I use it?	27

Cleaning and descaling the device.....	28
Cleaning coated WC ceramic appliances.....	28
Caring for and cleaning smooth surfaces.....	28
Removing the WC lid.....	28
Switching the device on and off.....	29
Automatic water replacement.....	31
General cleaning recommendations.....	31
Targeted disinfection.....	31
Suitable cleaning agents and cleaning equipment.....	31
Device descaling message.....	32
Descale the device.....	34
Cleaning the WC lid, WC seat ring and housing.....	36
Cleaning the flushing area of the WC ceramic appliance.....	37
Cleaning between the device and the WC ceramic appliance.....	37
Clean the spray nozzle.....	38
Replace the ceramic honeycomb filter.....	39
Troubleshooting.....	41
The shower toilet is not functioning.....	41
The remote control is without function.....	42
Replace the remote control battery.....	43
Re-assign remote control.....	44
Other functional errors.....	45
Sustainability.....	46
Geberit Group and sustainability.....	46
Ecodesign – ecobalance.....	46
Tips for reducing the ecological footprint.....	46
Constituents.....	46
Disposal of old electrical and electronic equipment.....	47
Conformity.....	47
Declaration of conformity.....	47
End user warranty.....	48
End user warranty.....	48
Technical data.....	49
Technical data.....	49

For your safety

Who is this product suitable for?

As a functioning toilet, the Geberit AquaClean shower toilet is suitable for all age groups. However, children must not carry out cleaning or maintenance work without supervision.

How is this product used?

The product is suitable for the following application purposes and areas of use:

- as a shower toilet:
 - for cleaning the anal area
 - for cleaning the outer vaginal area
 - for odour extraction
- for installation in heated indoor areas
- for connection to the drinking water system
- for operation with water from reverse osmosis systems

What should you avoid?

The product must be used as intended. Do not:

- leave the WC seat ring during the shower procedure
- place loads or objects on the WC lid
- immerse the remote control in liquid
- operate without plug for Geberit AquaClean descaling agent

Misuse

Geberit accepts no liability for the consequences arising from misuse.

General safety notes

The following safety notes apply for the entire duration of the product's life cycle:

- Read the user manual before the first use to familiarise yourself with the use of the product.
- Store the user manual for future reference.
- Impurities in the filter could lead to contamination of the breathing air. In order to preclude any health risks and ensure proper functioning, the filter must be replaced annually.
- Do not use the device if it is damaged. If possible, isolate the device from the supply system and contact Geberit customer service.
- Do not open the device. It does not contain any components for the user to service or repair.
- Do not perform any changes or additional installations. Modifying the device runs the risk of fatal danger.
- Repairs may only be carried out by authorised skilled persons using original spare parts.
- Only original accessories may be used.
- Operation and maintenance work may only be performed by the operator or user as described in this user manual.
- Always use the current version of the installation manual for installing the device if the Geberit AquaClean has been removed (e.g. if you move house).
- The Geberit AquaClean must only be connected to a mains voltage conforming to the specification plate.
- Observe the manufacturer information at all times regarding the use of cleaning and descaling agents.







This document contains warning notes at various points. Warning notes are usage and situation-specific safety notes. They provide warnings on specific hazards.





These instructions correspond to the state of the device technology at the time of printing. Geberit reserves the right to make changes in terms of further development.

A current version of this and other documents is available online. www.geberit.com

Overview of the alert levels and symbols in these instructions

Alert levels and symbols	
	DANGER Indicates an imminently threatening hazard which, if not avoided, will lead to death or serious injury.
	WARNING Indicates a potentially threatening hazard which, if not avoided, could lead to death or serious injury.
	CAUTION Indicates a hazard which, if not avoided, can lead to injury.
	ATTENTION Indicates a hazard which, if not avoided, can lead to material damage.
	Refers to important information.

Overview of symbols on the product

Symbol	Meaning
	Read the safety notes and operating instructions/ operation manual before commissioning the product.
	Danger of fatal electric shock

Register your device

Warranty registration

Extend the warranty period of your Geberit AquaClean for free. Register for this within 90 working days from the installation date.



In the third year of the warranty period, Geberit shall supply spare parts free of charge in the event of any material or manufacturing faults, provided the product has been installed and put into operation by an installation company.

By computer:

<http://www.geberit-aquaclean.com/registration>

By post:

Fill out the warranty card supplied and send it to us.

By smartphone or tablet:



Android:



iOS:



Via the Geberit AquaClean app:

Getting to know your device

About Geberit AquaClean devices

The Geberit AquaClean device is a WC with integrated shower function. The device fulfils all the functions of a conventional toilet. Additional functions are subject to the design of your product.

Functional overview

Hygiene functions:

- odour extraction unit with odour neutralisation through ceramic honeycomb filter
- optional odour extraction run-on function
- WhirlSpray shower technology with individual spray arm position
- optional spray arm oscillating function
- extendible Lady shower nozzle integrated into the spray nozzle with individual spray arm position
- automatic shower arm cleaning before and after each shower procedure
- optional dryer functionality via dryer opening

Comfort functions:

- confirmation sound when programming the shower toilet functions
- adjustable spray intensity and spray arm position
- WC seat with user recognition and WC seat heating
- WC seat and WC lid with SoftClosing
- main functions can be operated via a lateral ergonomic control panel
- can be operated entirely via remote control
- four individual user profiles and a basic profile can be stored

Cleaning and care:

- removable WC lid
- WC enhancement solution can be raised to clean between device and ceramic sanitary appliance
- descaling programme

Duration of shower procedures

Anal shower and Lady shower have different spray times.

- The spray time of the anal shower is 50 seconds. It can be stopped at any time by pressing the <Shower> button again.
- The spray time for the Lady shower is 30 seconds. It can be stopped at any time by pressing the <Shower> button again.

Duration of the drying procedure

The duration of the dryer functionality is 5 minutes. It can be stopped at any time by pressing the <Dryer> button again.

The device at a glance

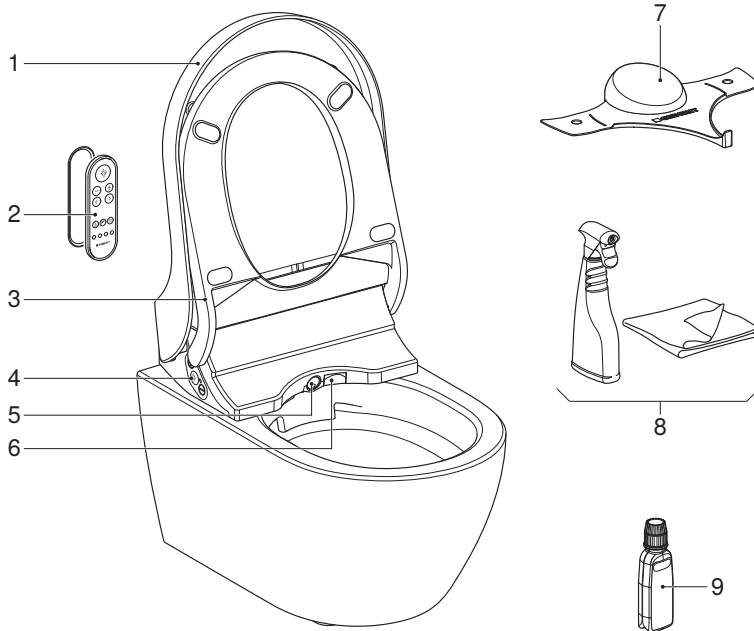

- 1 WC lid
- 2 Remote control with magnetic wall-mounted holder
- 3 WC seat ring with user recognition and WC seat heating
- 4 Lateral control panel with status LED
- 5 Spray arm with spray nozzle and Lady shower nozzle
- 6 Dryer flap
- 7 Spray shield
- 8 Geberit AquaClean cleaning set (art. no. 242.547.00.1)
- 9 Geberit AquaClean descaling agent (art. no. 147.040.00.1)

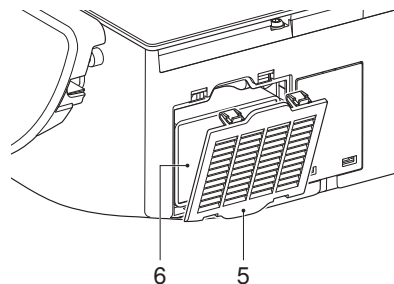
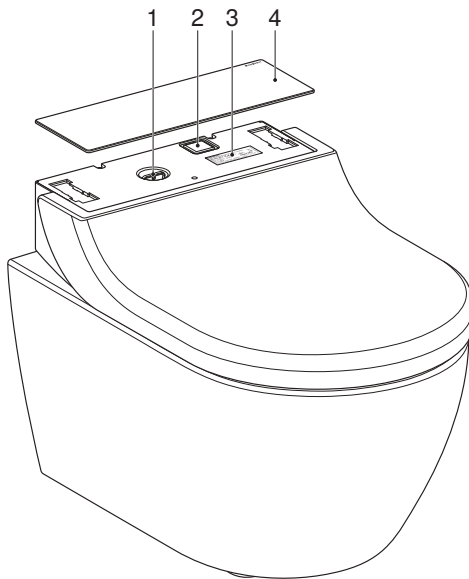
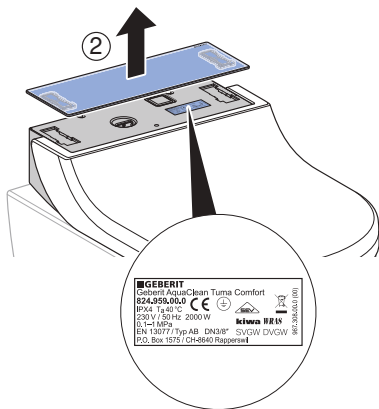
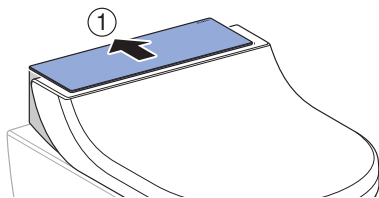

- 1 Filling opening with plug for Geberit AquaClean descaling agent
- 2 Power switch
- 3 Specification plate with serial number
- 4 Design cover
- 5 Filter compartment cover
- 6 Replaceable Geberit ceramic honeycomb filter, type 3 (art. no. 242.999.00.1)

Switching the device on and off

i A minimum of 30 seconds must be allowed between the switch-on procedure and the switch-off procedure in order for the electronics to be able to discharge completely.

1 Lift the WC lid.

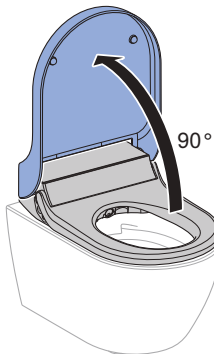

2 Remove the WC lid.

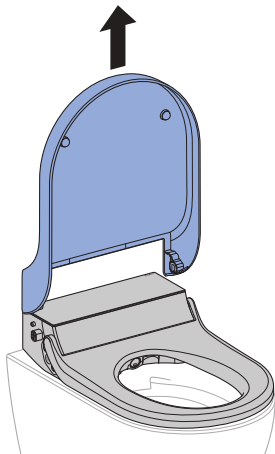

3 Remove the design cover.

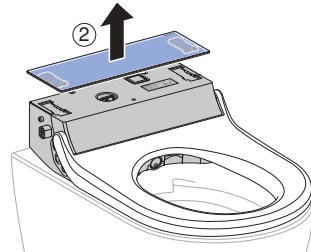
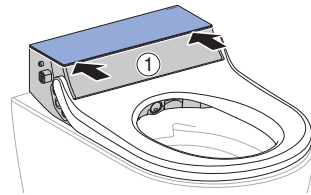

4 Press the power switch.

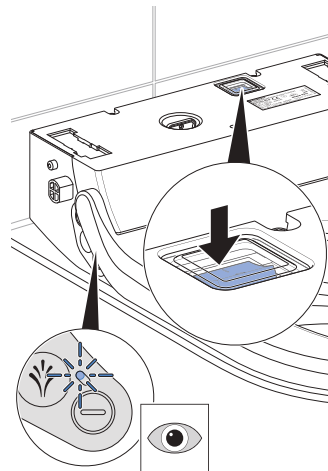

✓ The LED on the lateral control panel flashes/goes out.

5 Mount the design cover.

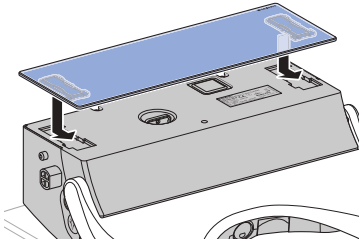

6 Mount the WC lid.

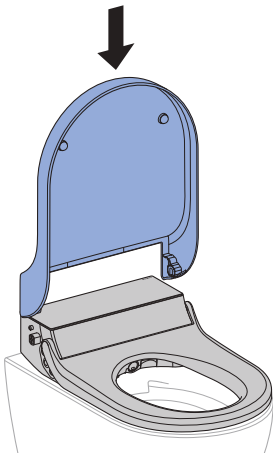

7 Close the WC lid.

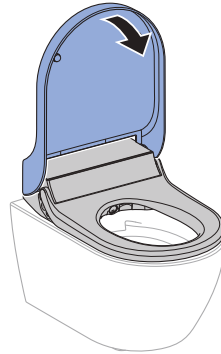

Result

- ✓ The device initialises again after switching on.

Operating concept

About the operating concept

The shower toilet can be operated via remote control, the lateral control panel and the Geberit AquaClean app.

Front side of the remote control

All shower toilet functions can be operated with the remote control.

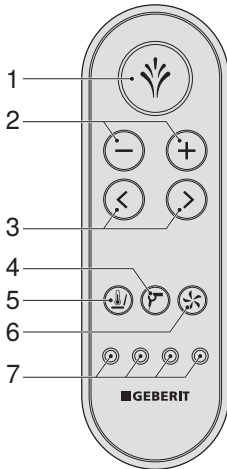

- 1 <Shower> button: start and stop the spray functionality/stop dryer functionality
- 2 <->/<+> buttons: decrease or increase the spray intensity
- 3 <left>/<right> arrow keys: set the spray arm position
- 4 <Dryer> button: start and stop the dryer
- 5 <WC seat heating> button: switch WC seat heating on/off
- 6 <Odour extraction> button: start and stop odour extraction
- 7 <User profile> buttons: activate the user profiles 1–4

Four user profiles can be stored via the <User profile> buttons on the remote control. → See "Quick saving of user profiles", page 26



User profiles allow you to access your personal settings directly. Select your user profile directly before or as soon as you sit down.

Rear side of the remote control

The battery compartment is located on the rear of the remote control.

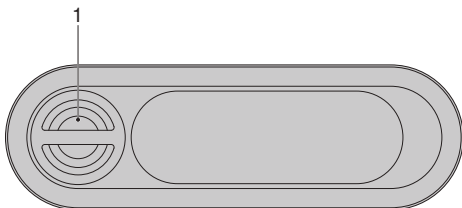

- 1 Battery compartment

Lateral control panel

The shower toilet functions of the device can be operated from the lateral control panel.

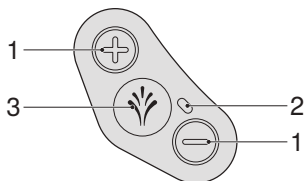

- 1 <+>/<-> buttons: increase or decrease the spray intensity
 2 Status LED
 3 <Shower> button: start or stop the anal shower or the Lady shower

Table 1: Status LED on the lateral control panel

LED	Description
Flashes blue	The device initialises after switching on. A system flush is performed.
Lights up blue	A user was recognised and water heating is activated in the basic settings. The LED switches off in economy mode.
Does not light up (no user)	Economy mode is active or the device is switched off.
Does not light up (during use)	Water heating and WC seat heating were deactivated in the basic settings.
Lights up red	The device must be descaled. → See "Descal the device", page 34
Flashes red	Malfunction message → See "The shower toilet is not functioning", page 41
Flashes red and lights up orange	The device is blocked and urgently needs to be descaled. The spray functionalities cannot be used when blocked. The block can be reset for 50 shower cycles. To implement this, the <Shower> button must be pressed for 5 seconds.

LED	Description
Lights up orange	The device is now descaling. It is not possible to use the shower toilet for the duration of the descaling procedure.
Flashes orange	Water replacement is being carried out. → See "Automatic water replacement", page 31
Flashes red/ orange	The device is in descaling mode and is waiting for a command from the user.

 The buttons of the control panel are designed ergonomically. Each button has an individual, tangible surface form.

Special assignment of the buttons

You can access advanced functions of your shower toilet using specially assigned buttons

Table 2: Remote control

Function	Button on the remote control	On	Off
Start the Lady shower	Press the <Shower> button for 2 seconds.	–	–
Save basic profile	Press <User profile 1> and <User profile 2> at the same time for 2 seconds.	Beep (1x)	–
Save user profile	Press the desired <User profile> button for 2 seconds.	Beep (1x)	–
Oscillating spray arm movement	Briefly press <left> and <right> at the same time.	–	–
Extend spray arm for cleaning	Briefly press <+> and <Shower> at the same time.	–	–
Re-assign remote control	Press <+> on the remote control and lateral control panel at the same time for 10 seconds.	Beep (1x)	–
Water heating	Press <+> and <WC seat heating> at the same time for 2 seconds.	Beep (1x)	Beep (2x)
Set the odour extraction run-on function	Press <Odour extraction> for 2 seconds.	Beep (1x)	Beep (2x)

 Four user profiles can be stored via the <User profile> button on the remote control. → See "Quick saving of user profiles", page 26

Table 3: Lateral control panel

Function	Button on the lateral control panel	On	Off
Start the Lady shower	Press the <Shower> button for 2 seconds.	–	–
Extend spray arm for cleaning	Briefly press <+> and <Shower> at the same time.	–	–
Re-assign remote control	Press <+> on the remote control and lateral control panel at the same time for 10 seconds.	Beep (1x)	–
Start the descaling function	Press <-> and <Shower> at the same time for 5 seconds.	–	–
Hide the descaling message for a further 50 shower cycles	Press the <Shower> button for 5 seconds.	Beep (1x)	–
Switch the demonstration mode on/off	Press <+> and <-> at the same time for 5 seconds.	Beep (1x)	Beep (2x)

Geberit AquaClean app

The following shower toilet functions can be executed via the Geberit AquaClean app:

- remotely controlling the Geberit AquaClean shower toilet
- displaying and adjusting the settings

The Geberit AquaClean app offers the following additional benefits:

- saving your personal settings on your smartphone
- support for care and maintenance of the device
- easy registration of your Geberit AquaClean shower toilet
- function films
- service and contact information

The Geberit AquaClean app is available free of charge for Android and iOS smartphones in the respective App Store.

Android:



iOS:



How to use the device

Your device settings



If a user is recognised, the basic profile is activated automatically with the basic settings.

During the shower procedure, you can adjust the shower procedure to your personal needs at any time. You can assign your individual settings to one of the four user profile buttons and specifically retrieve them from the next use.

Setting	Adjustment range	Factory setting of the basic profile
Spray intensity of the anal shower	level 1–5	level 3
Spray intensity of the Lady shower	level 1–5	level 1
Spray arm position of the anal shower	level 1–5	level 3
Spray arm position of the Lady shower	level 1–5	level 4
Oscillating function of the spray arm on the anal shower	on/off	on
Oscillating function of the spray arm on the Lady shower	on/off	off
Hot water of the spray functionality	on/off	on
WC seat heating function	on/off	on
Dryer functionality following shower procedure	on/off	on
Odour extraction function with user recognition	on/off	on
Odour extraction run-on function	on/off	off

Additional device settings in the Geberit AquaClean app

Setting	Adjustment range	Factory setting of the basic profile
Shower water temperature	level 1–5	level 4
Dryer temperature	level 1–5	level 5
Temperature of the WC seat heating	level 1–5	level 4
Water hardness	soft/medium/hard	hard

Adjusting the shower procedure to your personal needs

Getting started



The functions can be deactivated, activated or adjusted via the remote control or the Geberit AquaClean app.

- The device beeps (1x) when a function is activated.
- The device beeps (2x) when a function is deactivated.

The device is fitted with user recognition that responds to contact. The user must sit on the WC seat ring to activate it.

When you sit down on the WC seat ring,

- the device enables the spray functionality.
- WC seat heating starts.
- the odour extraction unit starts.

When you get up from the WC seat ring,

- the spray functionality deactivates.
- the dryer functionality deactivates.
- WC seat heating deactivates.
- the odour extraction unit deactivates.



The shower toilet automatically switches to economy mode as soon as a user is no longer recognised and no device functions are active.

Switch odour extraction run-on function on and off

Prerequisite

- You are sitting down on the WC seat ring.

- ▶ Press the <Odour extraction> button on the remote control for 2 seconds.

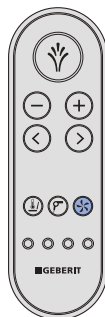

Result

- ✓ The odour extraction run-on function is activated when the device beeps (1x). The run-on time is 2 minutes and starts at the end of the final spray or dryer functionality.



By pressing the button again for 2 seconds, you can deactivate the function again.
The device beeps (2x).

Switch off the continuous flow heater

Prerequisite

- You are sitting down on the WC seat ring.

- ▶ Press the <WC seat heating> and <+> buttons on the remote control at the same time for 2 seconds.

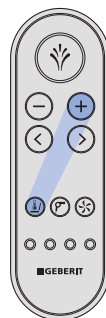

Result

- ✓ The device beeps (2x). The continuous flow heater is switched off.
- ✓ The shower procedure is performed with cold water.



By pressing the buttons again for 2 seconds, you can reactivate the function. The device beeps (1x).

Switch WC seat heating on and off

Prerequisite

- You are sitting down on the WC seat ring.

- ▶ Briefly press the <WC seat heating> button on the remote control.



Result

- ✓ WC seat heating is switched off.



It takes some time for a fully heated WC seat to cool down to the ambient temperature again.

Use the anal shower

Prerequisite

- You are sitting down on the WC seat ring.

- ▶ Briefly press the <Shower> button on the lateral control panel or on the remote control once.

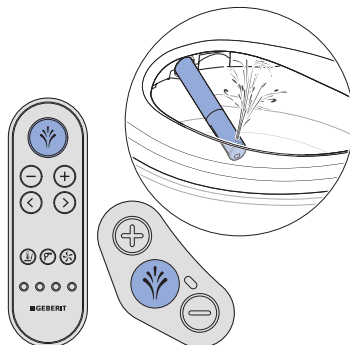

Result

- ✓ The shower procedure starts.
- ✓ The anal shower starts in oscillating function. A small amount of water drains into the WC ceramic appliance via the overflow. The anal shower is active for 50seconds.



You can stop the shower procedure early by pressing the <Shower> button once again.

Set the spray intensity

Prerequisite

- The shower procedure is running.

- ▶ Press the <+> button to increase the spray intensity. Press the <-> button to decrease the spray intensity.

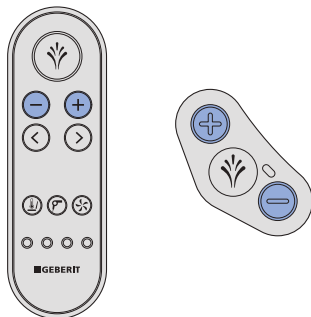

Result

- ✓ The shower spray becomes stronger/weaker.

- i** You can set the spray intensity in 5 stages.

Set the spray arm position

- i** Female users should set the spray arm position of the spray functionality to their ergonomic conditions so that it does not compromise the natural protection of the vaginal area.

Prerequisite

- The shower procedure is running.

- ▶ Press the arrow keys on the remote control to position the spray arm.

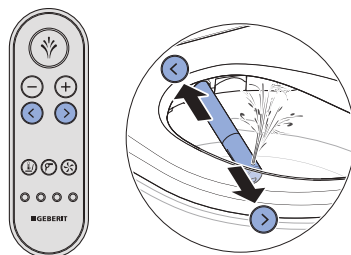

Result

- ✓ The spray arm is optimally positioned.

- i** You can set the spray arm position in 5 stages.

Switching the oscillating motion of the anal shower on and off

i The oscillating motion of the spray arm increases the cleaning effect.

Prerequisite

- The shower procedure is running.

- ▶ Press the <left> and <right> arrow keys at the same time to switch the oscillating motion off and on during the shower procedure.

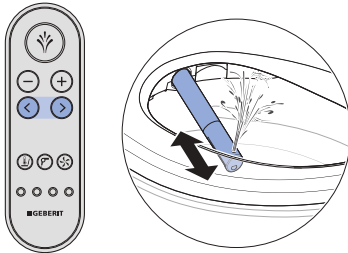

Use the Lady shower

i The woman's intimate area is a very sensitive zone and requires special and prudent care. The Lady shower must be set to your ergonomic conditions to achieve an optimal cleaning result. The position of the spray nozzle and the spray intensity must be selected so that the shower spray cannot penetrate the vagina.

Prerequisite

- You are sitting down on the WC seat ring.

- ▶ Press the <Shower> button on the lateral control panel or on the remote control for 2 seconds.

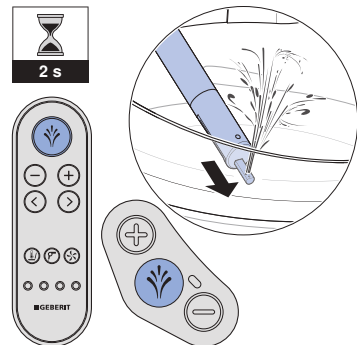

Result

- ✓ The Lady shower starts.

i You can stop the shower procedure early by pressing the <Shower> button once again.

Switching the oscillating motion of the Lady shower on and off

i In certain cases, using the oscillating motion of the spray arm with Lady shower function can cause germs to be spread from the anal area.

Prerequisite

- The Lady shower is running.

- ▶ Press the <left> and <right> arrow keys at the same time to switch the oscillating motion off and on during the Lady shower procedure.

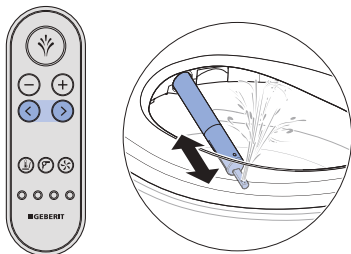

Use the dryer

Prerequisite

- The shower procedure is running.

- ▶ Stop the shower procedure.

Result

- ✓ The drying procedure will start automatically.

i The dryer is running for 5 minutes. The dryer functionality can be suspended with the <Dryer> button.

i The dryer functionality can be started during a shower procedure using the <Dryer> button. The drying procedure interrupts the spray functionality.

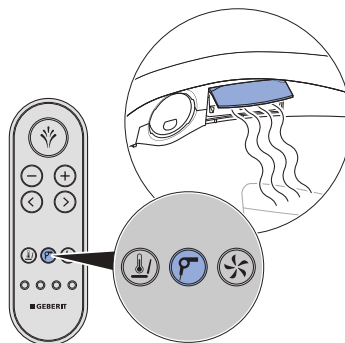

Quick saving of user profiles

Prerequisite

- You are sitting down on the WC seat ring.

- ▶ Press one of the four user profile buttons for more than 2 seconds during the drying procedure or at the end of the shower procedure to save the current settings.

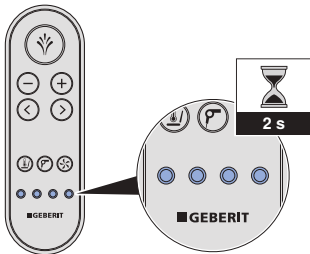

Result

- ✓ The device beeps (1x).

Quick saving of the basic profile

Prerequisite

- You are sitting down on the WC seat ring.

- ▶ Press the first two user profile buttons at the same time for more than 2 seconds during the drying procedure or at the end of the shower procedure to save the current settings to the basic profile.

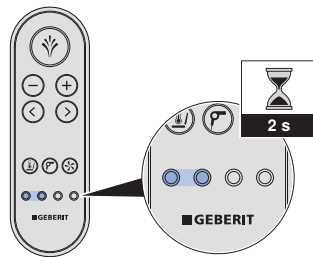

Result

- ✓ The device beeps (1x).

Saving your personal user profile in the Geberit AquaClean app



As long as you are in the detection range of the shower toilet, you do not need to activate the user recognition in order to save your user profile in the Geberit AquaClean app.

Prerequisite

- The current version of the Geberit AquaClean app is installed on your smartphone.
 - The Geberit AquaClean app is running.
 - You are in the detection range of the shower toilet.
-



Save your settings in the Geberit AquaClean app.

Result

- ✓ Your personal user profile is saved onto your smartphone.
- ✓ The settings apply to all connected shower toilets.

What happens after I use it?

After use, the device automatically prepares for the next use:

- The spray nozzle and Lady shower nozzle are rinsed thoroughly.
- The shower toilet automatically switches to economy mode as soon as a user is no longer recognised and no device functions are active.

Cleaning and descaling the device

Cleaning coated WC ceramic appliances

The WC ceramic appliance has a special coating. This coating draws water drops together to form spheres which drip away very effectively. Residue such as limescale and dirt is taken up by the water drops and simply flushed away with them. This effect is very environmentally friendly, as no aggressive WC cleaning agents are required.

Caring for and cleaning smooth surfaces

All smooth surfaces can be cleaned hygienically with water and a mild, liquid cleaning agent that is kind to the skin.



Aggressive and scouring cleaning agents can damage the surface. Only use mild, liquid cleaning agents that are kind to the skin. The Geberit AquaClean cleaning set (art. no. 242.547.00.1) includes a ready-made cleaning agent that is optimal for cleaning all Geberit AquaClean surfaces.

Removing the WC lid

1 Lift the WC lid.

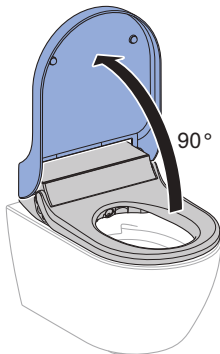

2 Remove the WC lid.

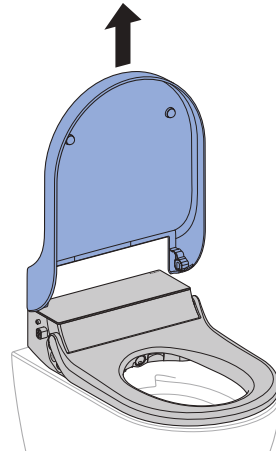

Switching the device on and off

i A minimum of 30 seconds must be allowed between the switch-on procedure and the switch-off procedure in order for the electronics to be able to discharge completely.

1 Lift the WC lid.

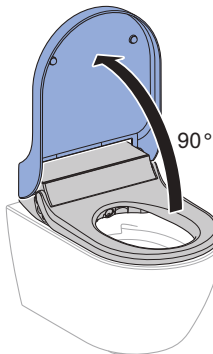

2 Remove the WC lid.

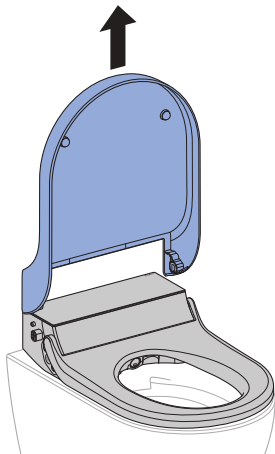

3 Remove the design cover.

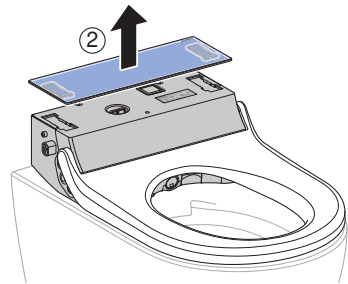
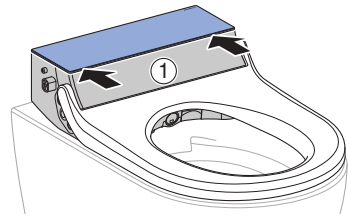

4 Press the power switch.

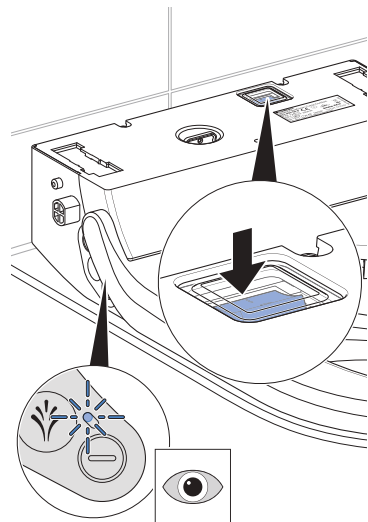

✓ The LED on the lateral control panel flashes/goes out.

5 Mount the design cover.

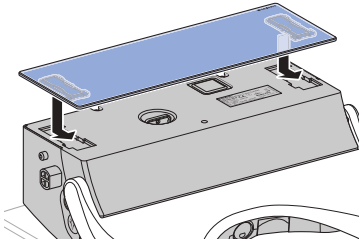

6 Mount the WC lid.

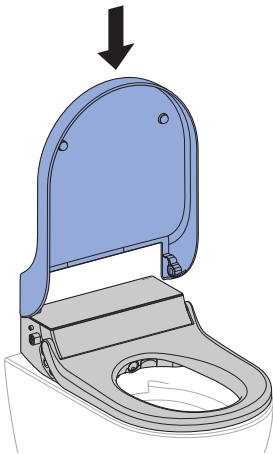

7 Close the WC lid.

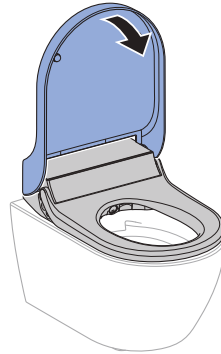

Result

- ✓ The device initialises again after switching on.

Automatic water replacement

If the shower toilet has been restarted or has not been used for more than 2 weeks, the device is rinsed with fresh water after it is switched on. This ensures optimum shower water quality before usage.

General cleaning recommendations

Cleaning interval	Cleaning activity
Daily	<ul style="list-style-type: none">Remove water drops with a soft, lint-free cloth to avoid limescale stains.
Weekly	<ul style="list-style-type: none">Clean all surfaces and corners thoroughly. → See "Cleaning the WC lid, WC seat ring and housing", page 36Test spray nozzle and clean if required. → See "Clean the spray nozzle", page 38
Monthly	<ul style="list-style-type: none">Rinse the spray nozzle under running water to remove foreign substances.Clean the WC ceramic appliance with Geberit AquaClean cleaning agent. → See "Cleaning the flushing area of the WC ceramic appliance", page 37

Targeted disinfection

Disinfection is only recommended if there is a definite risk of infection as a result of germs.

ATTENTION

Surface damage caused by aggressive disinfectants

- ▶ Only use alcohol-based disinfectants that are also suitable for hand and skin disinfection.
- ▶ Observe the safety notes from the manufacturer when handling hazardous substances.

Type of disinfection	Disinfection procedure
Wet wipe disinfection For use on smooth surfaces that can be rubbed	<ul style="list-style-type: none">▶ Moisten all surfaces with disinfectant.▶ Allow the disinfectant to take effect according to the manufacturer information.▶ Then rub the surfaces with single-use towels.
Spray disinfection Only for use on surfaces that are not easily accessible and cannot be rubbed	<ul style="list-style-type: none">▶ Spray the difficult-to-reach surface with disinfectant until wet.▶ Allow the disinfectant to take effect according to the manufacturer information.

Suitable cleaning agents and cleaning equipment

ATTENTION

Damage to the device from aggressive descaling agents





- ▶ Only use Geberit AquaClean descaling agent in the device.



ATTENTION

Surface damage caused by aggressive and scouring cleaning agents

- ▶ Use Geberit AquaClean cleaning agents.

The Geberit AquaClean cleaning set includes a ready-made cleaning agent that is optimal for cleaning all Geberit AquaClean surfaces.

Symbol	Characteristics of suitable cleaning agents
	Skin-friendly
	Cleaning agents are permitted to have a low acid content, e.g. heavily diluted citric acid
	Low-foaming
	Liquid
	Water-dilutable

Symbol	Suitable cleaning equipment
	Soft, fine-pored sponges
	Lint-free, soft cloths which are free of dust
	Toilet brush

Device descaling message

The device can be configured for the local water hardness in accordance with the following table via the Geberit AquaClean app. This adaptation prevents unnecessary descaling procedures and helps protect the environment. Nevertheless, regular descaling of the device is required.

Range	°fH	°dH	°eH
soft	≤ 15	≤ 8	≤ 11
medium	15–25	8–14	11–18
hard	> 25	> 14	> 18

 The device can continue to be used normally if the LED on the lateral control panel lights up red. Descaling should be carried out soon.

Frequency	Message	Fault clearance
At least once a year	<ul style="list-style-type: none"> The LED on the control panel lights up red. The Geberit AquaClean app displays the descaling message. 	<ul style="list-style-type: none"> ▶ Perform descaling.
Maximum number of shower cycles depending on the water hardness reached		
Double the maximum number of shower cycles depending on the water hardness reached	<ul style="list-style-type: none"> The LED on the control panel flashes red. The Geberit AquaClean app displays the descaling message. 	<p>Prerequisite</p> <ul style="list-style-type: none"> – A shower procedure is no longer possible without descaling. ▶ Perform descaling.

Descale the device

ATTENTION

Damage to the device from aggressive descaling agents

- ▶ Only use Geberit AquaClean descaling agent in the device.



- You will need to descale the device at least once a year, or more often depending on the number of shower cycles.
- During the descaling procedure, you can continue to use the WC without the spray functionalities.
- The descaling procedure lasts up to 30 minutes. Once the orange LED switches off, the spray functionality is once again ready for operation.
- Remove splashes of Geberit AquaClean descaling agent immediately with a damp cloth.

Prerequisite

- The LED on the control panel lights up red or it lights up orange and flashes red at the same time.
- The WC lid is removed.

- 1 Open the design cover.

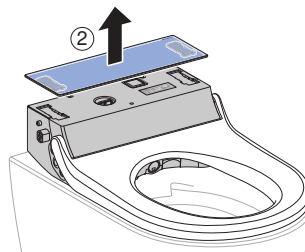
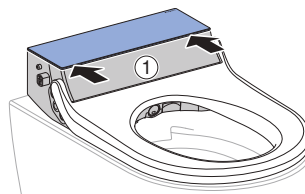

- 2 Remove the plug.

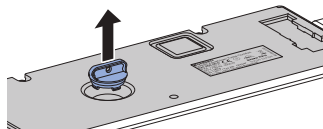

- 3 Press and hold the <-> and <Shower> buttons at the same time for more than 5 seconds on the lateral control panel.



- ✓ The LED on the lateral control panel flashes orange and red at the same time.

- 4** Pour around half a bottle of Geberit AquaClean descaling agent into the device.

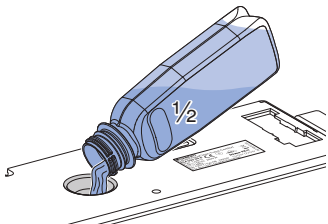

- 5** Press the <Shower> button on the lateral control panel.
- ✓ The LED lights up orange.
 - ✓ The device processes the descaling agent and a small quantity runs into the ceramic appliance. After around 15 seconds, the LED flashes orange and red on the lateral control panel at the same time.

- 6** Pour the remainder of the Geberit AquaClean descaling agent into the device.

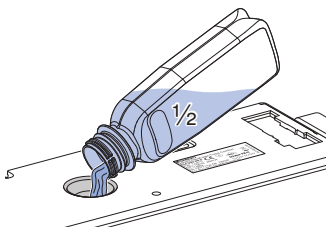

- 7** Re-insert the plug.

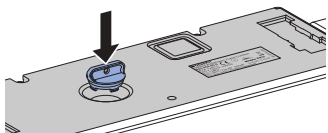

- 8** Close the design cover.

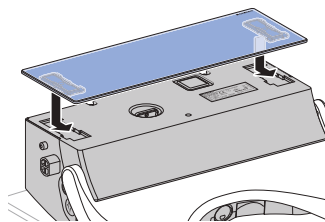

- 9** Mount the WC lid.

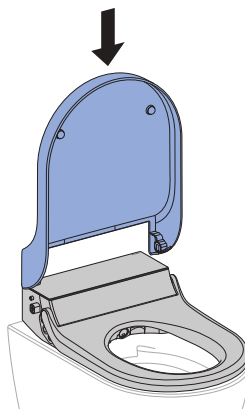

- 10** Press the <Shower> button on the lateral control panel.



- ✓ The LED lights up orange until the descaling programme is complete. Once the LED switches off, the device is once again ready for operation.

Cleaning the WC lid, WC seat ring and housing

i Be careful not to scratch the surface of the WC seat. Always place the components on a soft, non-scratching underlay.

1 Spray the surfaces with Geberit AquaClean cleaning agent. Wipe the surfaces with a soft, lint-free, damp cloth.

2 Open the WC lid.

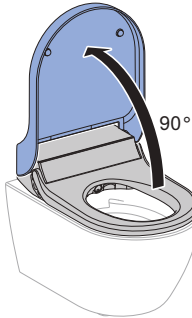

3 Remove the WC lid.

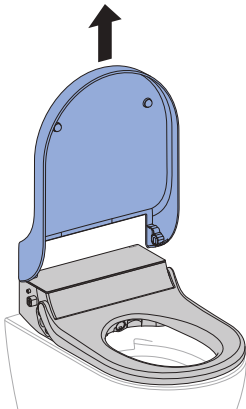

4 Remove the design cover for complete cleaning.

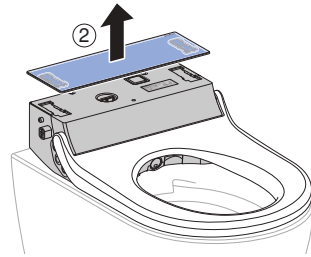
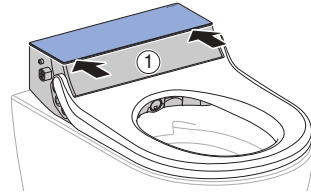

5 Spray the WC lid and the WC seat with Geberit AquaClean cleaning agent. Wipe the surfaces with a soft, lint-free, damp cloth.

6 Then dry all surfaces with a soft, lint-free cloth.

7 After cleaning is complete, re-assemble the device in reverse order of disassembly.

Cleaning the flushing area of the WC ceramic appliance

- 1 Spray the WC ceramic appliance with Geberit AquaClean cleaning agent and allow the cleaning agent a few minutes to take effect.
- 2 Finally, rinse the WC ceramic appliance with water.
- 3 Remove stubborn stains with a toilet brush.

Cleaning between the device and the WC ceramic appliance



WARNING

Danger of fatal electric shock
Water can flow into the device when it is moved without a removal limiter (safety line).

- ▶ Do not cut or damage the line of the removal limiter.
- ▶ Do not manipulate or remove the removal limiter.

- 1 Switch off the device.
- 2 Remove the device from the base plate.

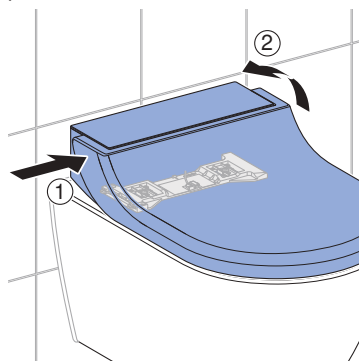

- 3 Lift the device as far as the removal limiter permits. Clean the gap between the shower toilet and ceramic sanitary appliance.

- 4** Mount the device on the base plate. Ensure that it is safely engaged.

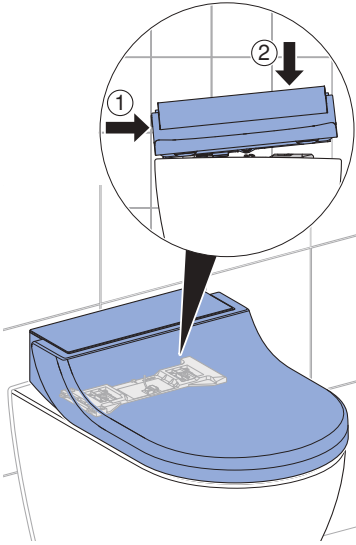

- 5** Switch on the device.

Clean the spray nozzle

- i**
- For cleaning, use a soft, lint-free cloth.
 - Geberit AquaClean cleaning agent is particularly suitable for all surfaces of the device.

- 1** Lift up the WC lid and the WC seat ring.
- 2** Press the <+> and <Shower> buttons at the same time.

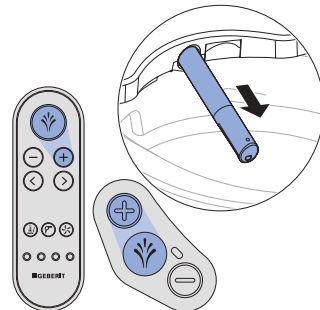

✓ The spray arm extends fully.

- 3** Hold the spray arm firmly and remove the spray nozzle from the front to clean and descale it. Always ensure that the spray nozzle moves parallel to the spray arm.

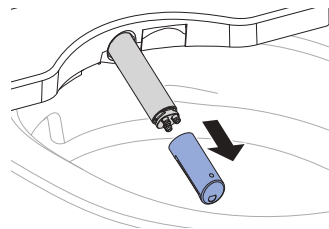

4 Replace the spray nozzle if it can no longer be completely cleaned and descaled.

5 Spray the spray arm with Geberit AquaClean cleaning agent. Then rinse it thoroughly with warm water.

6 Dry the spray nozzle carefully.

7 Mount the spray nozzle.

8 Press the <Shower> button.

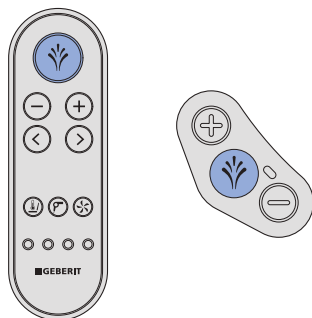

✓ The spray arm retracts fully. The cleaning procedure is now complete.

Replace the ceramic honeycomb filter



WARNING

Danger of fatal electric shock
Water can flow into the device when it is moved without a removal limiter (safety line).

- ▶ Do not cut or damage the line of the removal limiter.
- ▶ Do not manipulate or remove the removal limiter.



CAUTION

Possible health hazard
Impurities in the filter could lead to contamination of the breathing air.

- ▶ Replace the filter annually.



The ceramic honeycomb filter is located on the right rear side of the device below a cover. It is fastened with 2 catch springs.

1 Remove the device from the base plate.

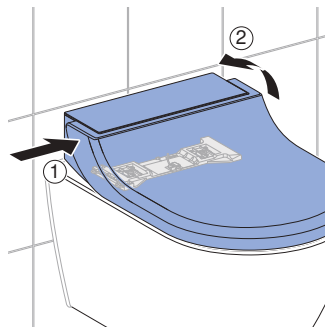

-
- 2** Turn the device a little in a clockwise direction until you have access to the filter cover.

-
- 3** Bend the catch springs of the filter cover slightly downwards and open the cover.

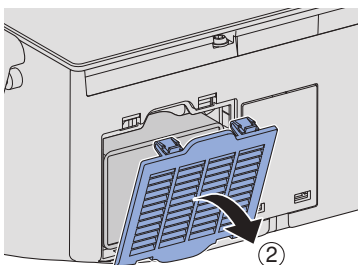
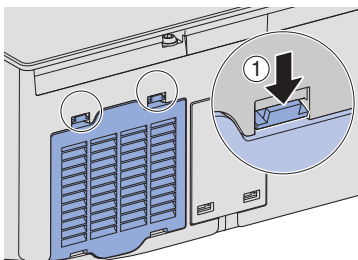

-
- 4** Remove the used filter from the opening. Then insert the new filter.

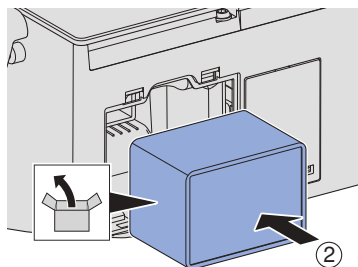
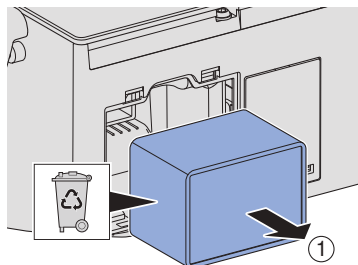

-
- 5** Close the cover again.

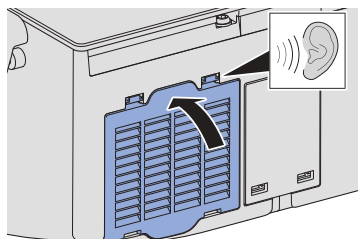

-
- 6** Mount the device on the base plate. Ensure that it is safely engaged.

Result

- ✓ Odour neutralisation will now function again.

Troubleshooting

The shower toilet is not functioning

The following table will help you with troubleshooting if the shower toilet is without function.



DANGER

Danger of fatal electric shock

- ▶ Do not open the device.
- ▶ Do not attempt to repair the device yourself.
- ▶ Do not modify the device.
- ▶ Do not replace damaged mains connection cables yourself.



The shower toilet can be used as a normal toilet even in the event of a malfunction. The spray arm must be fully retracted. You start the toilet flush as usual by pressing the buttons on the cistern.



If the device is defective, switch it off using the power switch.

Step	Description of problem	Fault clearance
1	The shower toilet and the status LED are without function.	<ul style="list-style-type: none">▶ Switch the device off and on again. → See "Switching the device on and off", page 29 Result ✓ The device re-initialises.
2	The fuse or residual-current device in the electrical distributor trips once.	<ul style="list-style-type: none">▶ Replace or reset the fuse in the electrical distributor.▶ Reset the residual-current device in the electrical distributor. Result ✓ The device initialises again after switching on. Using the device does not trip any fuses or residual-current devices.
3	The fuse or residual-current device in the electrical distributor trips repeatedly when the device is used.	<ul style="list-style-type: none">▶ Disconnect the mains plug (if available).▶ Replace or reset the fuse or residual-current device in the electrical distributor.▶ Contact customer service. Result ✓ The device is defective.

Step	Description of problem	Fault clearance
4	The product has an unknown technical defect.	<ul style="list-style-type: none"> ▶ Trip the fuse or residual-current device in the electrical distributor. ▶ Disconnect the mains plug (if available). ▶ Contact customer service. ▶ Have the power supply tested by a skilled person.

The remote control is without function

The following table will help you with troubleshooting if:

- the remote control is not functioning,
- the remote control is unable to control the shower toilet.



The remote control is inactive while the AquaClean app is in use.



Should the remote control fail to function, you can use the lateral control panel instead.



If the device should be defective, then it can be switched off using the power switch.

Step	Description of problem	Fault clearance
1	The shower toilet can only be operated using the lateral control panel and not using the remote control.	<ul style="list-style-type: none"> ▶ Re-assign the remote control. → See "Re-assign remote control", page 44 <p>Result</p> <ul style="list-style-type: none"> ✓ The device beeps (1x) and the blue LED on the lateral control panel lights up for 4 seconds.
2	The remote control is unable to control the shower toilet. The remote control has been re-assigned.	<ul style="list-style-type: none"> ▶ Replace battery (type CR2032). → See "Replace the remote control battery", page 43 ▶ Re-assign the remote control. → See "Re-assign remote control", page 44
3	The battery has been replaced and the remote control has been re-assigned. The shower toilet can only be operated using the lateral control panel and not using the remote control.	<ul style="list-style-type: none"> ▶ Contact customer service. <p>Result</p> <ul style="list-style-type: none"> ✓ Remote control is defective.

Replace the remote control battery

Prerequisite

- During the entire procedure, the remote control must be located in the reception range of the shower toilet.

- 1 Remove the used battery. Dispose of the used battery appropriately.

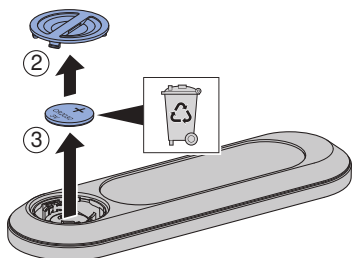
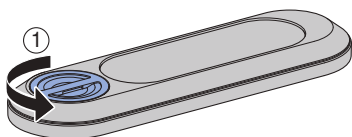

- 2 Insert a new CR2032 battery. The device beeps (1x) and the blue LED on the lateral control panel lights up for 4 seconds.

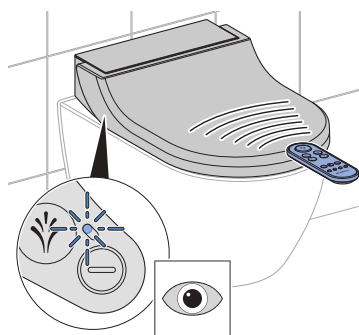
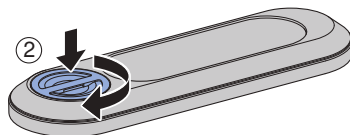
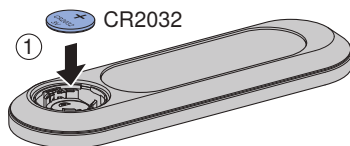

Re-assign remote control

- i** The device can only be operated with a single, assigned remote control.
-

- ▶ Press the <+> button on the remote control and the <+> button on the lateral control panel at the same time for approx. 10 seconds.

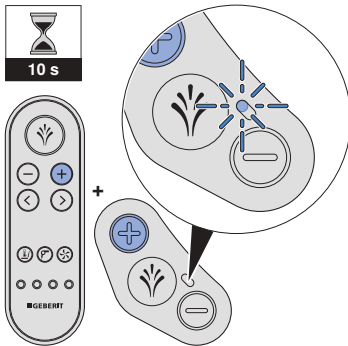

Result

- ✓ The device beeps (1x) and the blue LED on the lateral control panel lights up for 4 seconds.
- ✓ The shower toilet can be controlled by remote control.

Other functional errors

The following table will help you with troubleshooting if individual functions of the shower toilet have failed.



The shower toilet can be used as a normal toilet even in the event of a malfunction. The spray arm must be fully retracted. You start the toilet flush as usual by pressing the actuator buttons.



If the device is defective, switch it off using the power switch.

Step	Description of problem	Fault clearance
1	Odour neutralisation is weak or ineffective.	<ul style="list-style-type: none"> ▶ Replace the ceramic honeycomb filter. → See "Replace the ceramic honeycomb filter", page 39.
2	The device does not work at all or partly incorrectly.	<ul style="list-style-type: none"> ▶ Switch off the shower toilet at the power switch for 30 seconds. ▶ Switch on the shower toilet at the power switch again. <p>Result ✓ The device initialises again after switching on.</p>
3	The cleaning effect of the shower has weakened.	<ul style="list-style-type: none"> ▶ Clean or replace the spray nozzles. → See "Clean the spray nozzle", page 38. ▶ Descale the device. → See "Descale the device", page 34.
4	When using the shower function, the shower toilet no longer reaches the usual temperature.	<ul style="list-style-type: none"> ▶ Descale the device. → See "Descale the device", page 34. ▶ Switch off the shower toilet at the power switch for 30 seconds. ▶ Switch on the shower toilet at the power switch again. <p>Result ✓ The device initialises again after switching on.</p>

Sustainability

Geberit Group and sustainability

As the European market leader in the sanitary industry, Geberit stands for water saving, resource efficiency and sustainable building. The Group has proven for decades that long-term business success is compatible with environmentally friendly actions and social policies. A company management geared to sustainability helps to save costs while minimizing risks at the same time. Geberit aims to act as a role model and set standards for its customers, suppliers and other partners. This means creating water-saving and sustainable products, using safe, environmentally friendly and resource-efficient production practices, engaging in purchasing and logistics activities with high environmental and ethical standards, and offering excellent working conditions for more than 12 000 dedicated and highly qualified employees worldwide. One way in which the company is showing its awareness of social responsibility is by participating in water relief projects around the world.

Ecodesign – ecobalance

The basis for sustainable products is formed by a systematic innovation process in which product materials and functional principles are chosen that are as environmentally friendly as possible, risks are minimised and a high degree of resource efficiency is strived for. We can supply a detailed ecobalance for this product upon request.

Tips for reducing the ecological footprint

This product was developed with the utmost care, also with regard to the consumption of energy, water and resources (see also technical data). You can reduce the ecological footprint of the product by observing the following recommendations:

- Switch off the device when you go on holiday.
- Interrupt the spray functionality manually in order to save hot water.
- Use small amounts of paper for drying.
- Switch off the heating function of the water heater when you do not need warm shower water.
- Use environmentally friendly cleaning agents.
- Carry out regular maintenance on the device and handle it with care in order to extend the service life.
- Return defective devices to Geberit or a designated partner for appropriate disposal.

Constituents

This product conforms to the requirements of the directive 2011/65/EU:2011-06-08 (Directive on the Restriction of the Use of Certain Hazardous Substances in Electrical and Electronic Equipment) and is free from environmental pollutants such as lead, mercury, cadmium and chrome VI.

The European chemical regulation EC Regulation 1907/2006:2006-12-18 (Regulation on the Registration, Evaluation, Authorisation and Restriction of Chemicals (REACH)), which regulates the registration, assessment, approval and restriction of certain chemical substances, is also complied with.

Disposal of old electrical and electronic equipment



In accordance with Directive 2012/19/EU (WEEE - Waste Electrical and Electronic Equipment) manufacturers of electrical equipment are obliged to take back old equipment and to dispose of it appropriately. The symbol indicates that the product cannot be disposed of with non-recyclable waste. Old equipment should be returned directly to Geberit where it will be disposed of appropriately. Addresses to which equipment can be returned can be requested from the relevant Geberit sales company.

Conformity

Declaration of conformity

You can obtain a copy of the declaration of conformity from your responsible Geberit sales company.

End user warranty

End user warranty

The following end user warranty is provided in addition to and does not affect your contractual partner's liability for defective products.

The Geberit company ("Geberit") responsible for the place of installation of the Geberit AquaClean product ("product") shall provide the end user with a warranty for the product identified by the serial number on the warranty card. The scope of this warranty is as follows:

1. Geberit guarantees that the product shall be free from material defects and manufacturing faults for a period of 3 years ("warranty period") calculated from the installation date at the end user's premises. Warranty scope:
 - a) Within the first 2 years of the warranty period, a customer service representative authorised by Geberit shall rectify any material defects or manufacturing faults free of charge by repairing or replacing the defective parts.
 - b) In the third year of the warranty period, Geberit shall supply replacements for defective parts free of charge to the customer service representative authorised by Geberit and contracted by the end user to repair the product.
2. The end user shall not be entitled to assert more extensive claims against Geberit on the basis of this warranty.
3. Claims can only be made under the warranty if:
 - a) The product has been installed and put into operation by an installation company or by customer service personnel authorised by Geberit.
 - b) No modifications have been made to the product; in particular, no parts have been removed, replaced or added.
 - c) The product defect has not been caused by improper installation or use, nor can it be attributed to inadequate care or maintenance.
 - d) Claims shall only be made during the third year of the warranty period if the end user has completed the enclosed warranty card in full and returned it to the Geberit company responsible for the place of installation within 90 working days of the installation date.
4. This warranty applies solely to places of installation in countries in which Geberit has its own sales company or is represented by a sales partner.
5. The warranty is exclusively subject to the substantive law of the country in which Geberit has its place of business. The United Nations Convention on Contracts for the International Sale of Goods is expressly excluded. The exclusive place of jurisdiction for all disputes arising from or in connection with this warranty is the location of Geberit's headquarters.

Technical data

Technical data

Nominal voltage	230 V AC
Mains frequency	50 Hz
Power consumption	2000 W
Power consumption standby	≤ 0.5 W
Protection degree	IPX4
Protection class	I
Mains connection	Mains connection via system plug with flexible three-wire sheathed cable
Spray time	50 s
Number of shower pressure settings, shower spray	5
Water temperature	37 °C
Operating temperature	5-40 °C
Flow pressure	50-1000 kPa
	0.5-10 bar
Minimum flow pressure	0.5 bar
	50 kPa
Calculated flow rate	0.02 l/s
Maximum load, WC seat	150 kg

(CH) Geberit Vertriebs AG

Schachenstrasse 77
CH-8645 Jona
T 0848 882 982
www.geberit-aquaclean.ch

(DE) Geberit Vertriebs GmbH

Kundendienst/Servicestelle
Theuerbachstrasse 1
D-88630 Pfullendorf
T (075 52) 934 10 11
F (075 52) 934 866
www.geberit-aquaclean.de

(AT) Geberit Vertriebs GmbH & Co. KG

Geberitstrasse 1
A-3140 Pottenbrunn / St. Pölten
T +43 2742 401-400
F +43 2742 401-50
www.geberit-aquaclean.at

(AE) Geberit International Sales AG

Dubai Branch
B702-B705
Building No. 1
Dubai Design District
PO Box
UAE-282317 Dubai
T +971 4 204 5477
F +971 4 204 5497
www.geberit.ae

(BE) Geberit nv

Beaulieustraat 6
B-1830 Machelen
T +32 2 252 0111
F +32 2 251 0867
www.geberit-aquaclean.be

(BG) Юнитрейд Интернешънъл ЕООД

бул. "Черни връх" 161-А
1407 София
T 02/ 968 11 11
F 02/ 968 10 01
www.unitrade-bg.com

(CN) 吉博力(上海)贸易有限公司

地址: 上海市嘉定区南翔高科
技园区惠平路1515号
邮编: 201802

(CZ) Geberit spol. s r.o.

Sokolovská 2408/222
190 00 Praha 9
T +420 547 212 335
F +420 547 212 340
www.geberit.cz

(DK) Geberit A/S

Lægårdsvej 26
DK-8520 Lystrup
T +45 86 74 10 86
F +45 86 74 10 98
www.geberit-aquaclean.dk

(ES) Geberit, S.A.U.

Plaza Europa, 2-4, 6ª planta
ES-08902 L'Hospitalet del Llobregat
(Barcelona)
T +34 902 170 635
www.geberit-aquaclean.es

(FI) Geberit Oy

Tahkotie 1
FI-01530 Vantaa
P +358 9 867 8450
www.geberit.fi

(FR) Geberit France

ZA du Bois Gasseau - CS40252
Samoreau
FR-77215 Avon Cedex
Téléphone 01 60 71 66 61
T +33(0)825 801 603
F +33(0)825 801 604
www.geberit-aquaclean.fr

(GB) Geberit Sales Ltd.

Geberit House
Edgehill Drive
Warwick
CV34 6NH
T (0)1926 516 800
T (0)1926 516 809
In Eire T +44 1622 717 811
www.geberit-aquaclean.co.uk

(HR) Predstavništvo Geberit

prodaja d.o.o. Ruše
Samoborska cesta 218
10090 Zagreb, HR
T +385 1 3867 800
F +385 1 3867 801
www.geberit.hr

(HU) Geberit Kft

1117 Budapest,
Alíz utca 2.
T +36 1 204 4187
www.geberit.hu

(IT) Geberit Marketing e Distribuzione SA

Via Gerre 4
CH-6928 Manno
T +41 91 611 92 92
F +41 91 611 93 93
www.geberit-aquaclean.it

(LU) Geberit Luxembourg

61, avenue de la Libération
L-3850 Schifflange
T +352 54 52 26
F +352 54 54 91
www.geberit.lu

(NL) Geberit B.V.

Fultonbaan 15
3439 NE Nieuwegein
T +31 (0)3060 57700
F +31 (0)3060 53392
www.geberit-aquaclean.nl

(NO) Geberit AS

Luhrtoppen 2
N-1470 Lørenskog
T +47 67 97 82 00
www.geberit-aquaclean.no

(PL) Geberit Sp. z o.o.

ul. Postepu 1
02-676 Warszawa
T +48 22 843 06 96
www.geberit-aquaclean.pl

(PT) Geberit Tecnologia Sanitária, S.A

Rua Cupertino de Miranda, nº 12-2º A
PT-1600-485 LISBOA
www.geberit.pt

(RO) Geberit International Sales AG

Splaiul Unirii, Nr. 86, Et. 3
Sector 4, Bucharest
T +40 21 330 30 80/81
F +40 21 330 31 61
www.geberit.ro

(RS) Geberit - Predstavništvo za

Republiku Srbiju i Republiku Crnu Goru
Vojvode Skopljanca 24
SR-11000 Beograd
T + 381 11 30 96 430
F + 381 11 30 96 431
www.geberit.rs

(RU) ООО „ГЕБЕРИТ РУС“

Олимпийский пр., 16, стр.5, 5 этаж
129110 Москва
тел.: +7 495 783 83 30
www.geberit.ru

(SE) Geberit AB

Folketshusgatan 1
Box 140
295 22 Bromölla
T +46 40 680 89 30
www.geberit.se

(SI) Geberit prodaja, d.o.o.

Bežena 55
2342 Ruše
T 01 586 22 00
F 01 586 22 19
www.geberit.si

(SK) Geberit Slovensko s.r.o.

Karadžičova 10
821 08 Bratislava 2
F +421 2 49 20 30 71
www.geberit.sk

(TR) Geberit Tesisat Sistemleri Tic. Ltd. ti.

Içerenköy Mah. Engin Sok. No. 10,
34752 Ataşehir-Ystanbul, Turkey
T +90 216 340 82 73
F +90 216 340 82 79
www.geberit.com.tr

(ZA) Geberit Southern Africa (Pty.) Ltd.

6 Meadowview Lane,
Meadowview Business Estate,
Longmeadow,
Linbro Park
Johannesburg,
South Africa
T +27 11 444 5070
F +27 11 444 5992
www.geberit.co.za