

# FIXING INSTRUCTIONS FOR SHOWER TRAYS

**HANDLE WITH CARE - DO NOT DROP -  
READ INSTRUCTIONS CAREFULLY BEFORE INSTALLATION**

## GENERAL CARE

During installation, protect tray with cardboard, cloth or a soft cover. Strong chemicals such as polish and disinfectants can damage the surface as can blow lamps or hot metal from soldering.

## BEFORE INSTALLATION - CHECKLIST

1. Carefully remove outer packaging. Check colour/size of tray.
2. Remove the clear protective film from the tray and check that there is no visible damage/faults, (any defects must be reported to the manufacturer **before** installation). Claims for imperfections will only be accepted prior to installation.
3. Check surface on which tray will be installed is level.
4. Check there is sufficient access to waste and pipe work below floor level.
5. Shower tray should be installed **before** tiling to ensure that top of tray is either below bottom edge of tiles or behind tiles - see figure 1. This helps to create a watertight seal between tray and wall joints.
6. **Important** - when positioning tray ensure that, after tiling, there is sufficient space for the installation of the shower enclosure - **refer overleaf to enclosure adjustment sizes**.

## TIMBER FLOORS

7. Check floorboards are securely fixed. If in doubt cut a piece of green grade chipboard (18-20mm) to size of tray and position where it will eventually sit. **N.B. Before securing floorboards or chipboard make sure that there are no electrical connections or pipe work beneath floor level.**

8. Carefully place tray and drill hole in floor for waste. Diameter must accommodate entire waste coupling so that it falls below floor level.

## SOLID OR RESTRICTED ACCESS FLOORS

9. Utilise the KUDOS plinth or construct a plinth on which to rest the tray. This must accommodate waste trap. See figure 2 opposite.

## INSTALLATION

10. Use clear waterproofing agent to seal installation area.
11. Create watertight seal around waste using a silicone sealant or plumbers mate. Position and fit waste and trap to base. **N.B. Do not use putty or other mastics as they may damage the tray material.**
12. Using either tile adhesive-cement based & not ready mixed- or a weak cement mix (5 parts sand/ 1 part cement) apply sufficient to board to cover entire underside of tray. Apply a minimum of 5mm thickness to lowest point of tray. More may be required in places to ensure tray is level. When complete the whole of the tray should be supported by at least 5mm of cement.
13. Ensure that **top** of tray is level in all directions, in particular where the enclosure sits. Please note the standing area of the tray falls away slightly towards the waste to allow drainage.
14. **Before** tiling, any gap between the tray and the walls must be filled with silicone sealant flush with the top of the tray. After tiling, **but before fitting enclosure**, the tiles must be silicone sealed to the tray all of the way around in one continuous bead.

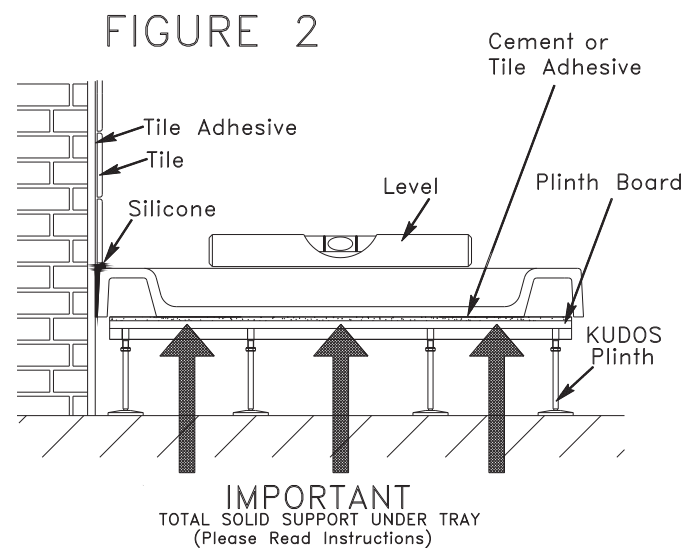
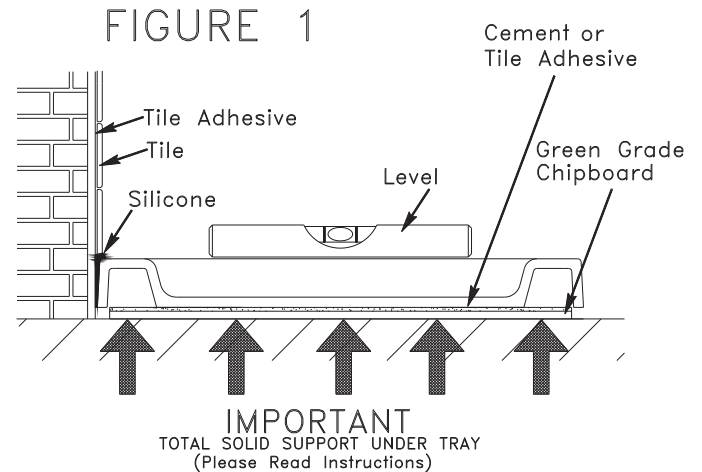

## WE RECOMMEND THE FOLLOWING WASTES

**For Concept 1** (95mm Tray) - Standard trap with 70mm flange and 90mm depth.

**For Concept 2** (55mm Tray) - Kudos waste available at time of purchase.

The KUDOS Concept 2 Plinth is designed to accommodate both trays and waste systems but if a timber support is built, it may be necessary to modify slightly for each option - to avoid interference with the underside of the green grade chipboard.

## CLEANING

**SHOWER TRAY:** Clean immediately after use to prevent a build up of scale or dirt. Warm soapy water should be used to clean the surface. Any crevices may be cleaned using a soft bristled brush. Rinse and wipe dry with a soft clean cloth or towel. Avoid all abrasives or harsh detergents.

**WASTE FITTINGS:** Warm soapy water and a few drops of washing up liquid. Do not use cream cleaners or scouring products on chrome as this may damage the surface and be a source of corrosion. Follow the manufacturers own recommendations for cleaning waste fittings etc.

**STRAIGHT PIVOT / BIFOLD DOORS**

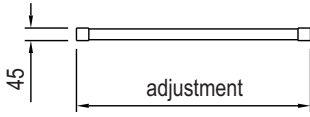

ADJUSTMENT mm		
PRODUCT SIZE	RECESS door only	CORNER door + 1 side panel
760 Pivot / Bifold	705 - 745	732 - 752
800 Pivot / Bifold	745 - 785	772 - 792
900 Pivot / Bifold	845 - 885	872 - 892
1000 Pivot-Wide	945 - 985	972 - 992
1100 Pivot-Wide	1045 - 1085	1072 - 1092
1200 Pivot-Wide	1145 - 1185	1172 - 1192

**STRAIGHT SLIDER DOORS**

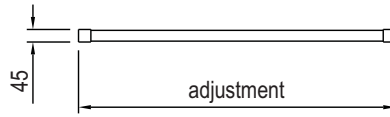

ADJUSTMENT mm		
PRODUCT SIZE	RECESS door only	CORNER door + 1 side panel
1000 Slider	945 - 985	972 - 992
1100 Slider	1045 - 1085	1072 - 1092
1200 Slider	1145 - 1185	1172 - 1192
1400 Slider	1345 - 1385	1372 - 1392
1500 Slider	1445 - 1485	1472 - 1492
1600 Slider	1545 - 1585	1572 - 1592
1700 Slider	1645 - 1685	1672 - 1692

**BOWED PIVOTS / SLIDER**

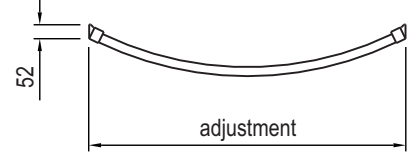

ADJUSTMENT mm		
PRODUCT SIZE	RECESS door only	CORNER door + 1 side panel
800 Pivot	755 - 785	775 - 790
900 Pivot	855 - 885	875 - 890
1200 Pivot / Slider	1145 - 1175	1165 - 1180
1500 Slider	1445 - 1475	1465 - 1480
1700 Slider	1630 - 1660	1650 - 1665

**STRAIGHT CORNER SLIDER**

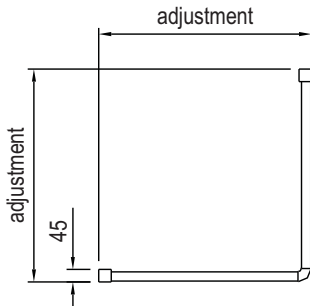

ADJUSTMENT mm	
PRODUCT SIZE	CORNER ENCLOSURE
760	725 - 745
800	765 - 785

**CURVED SLIDERS / PIVOTS**

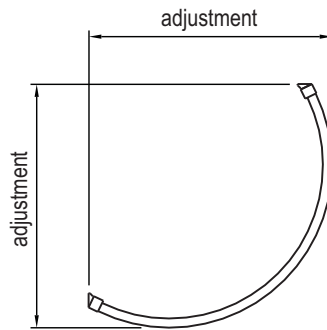

ADJUSTMENT mm	
PRODUCT SIZE	CORNER ENCLOSURE
810 Curved	780 - 795
910 Curved	880 - 895
1000 Curved	970 - 985
1000 x 810 Offset	970 - 985 / 780 - 795
1200 x 910 Offset	1170 - 1185 / 880 - 895

**OFFSET CURVED SLIDER / PIVOT**

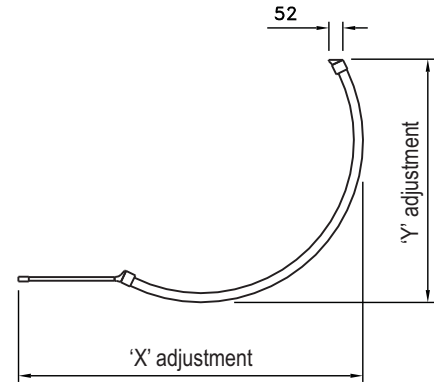

ADJUSTMENT mm	
PRODUCT SIZE	CORNER ENCLOSURE
1270 Offset Pivot	'X' 1240 - 1260
	'Y' 880 - 895
1270 Offset Slider	'X' 1245 - 1260
	'Y' 880 - 895

**PENTAGRA ENCLOSURE**

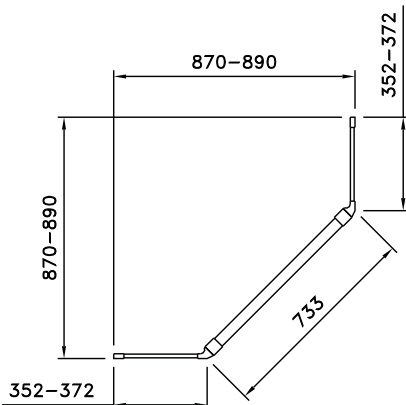

**CURVED QUADRANT PIVOT**

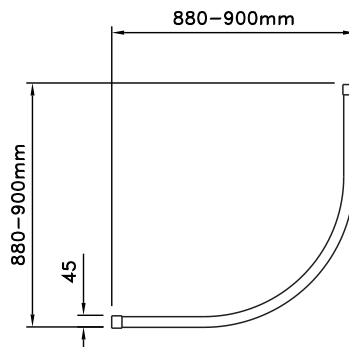

**ENCLOSURE PANELS**

STANDARD

SPECIAL

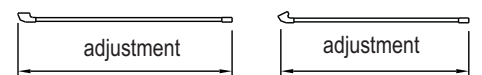

ADJUSTMENT mm	
PRODUCT SIZE	SIDE PANEL
700 Special Side Panel ( <i>Bowed Doors Only</i> )	685 - 700
800 Special Side Panel ( <i>Bowed Doors Only</i> )	785 - 800
700 Standard Side Panel	672 - 687
760 Standard Side Panel	732 - 747
800 Standard Side Panel	772 - 787
900 Standard Side Panel	872 - 887

**CENTRE FOLDING DOOR**

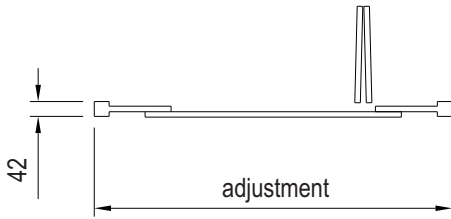

ADJUSTMENT mm			
PRODUCT SIZE	RECESS door only	CORNER door + 1 side panel	PENINSULAR door + 2 side panels
760	725 - 765	731 - 751	737
800	765 - 805	771 - 791	777
900	865 - 905	871 - 891	877
1000	965 - 1005	971 - 991	977
1200	1165 - 1205	1171 - 1191	1177

**STRAIGHT HINGED / SLIDER DOORS**

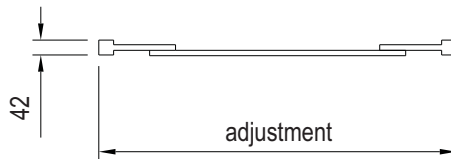

ADJUSTMENT mm			
PRODUCT SIZE	RECESS door only	CORNER door + 1 side panel	PENINSULAR door + 2 side panels
800 Hinged	765 - 805	771 - 791	777
900 Hinged	865 - 905	871 - 891	877
1000 Hinged	965 - 1005	971 - 991	977
1200 Hinged / Slider	1165 - 1205	1171 - 1191	1177
1500 Hinged / Slider	1465 - 1505	1471 - 1491	1477
1700 Slider	1665 - 1605	1671 - 1691	1677

**BOWED HINGED / SLIDER DOORS**

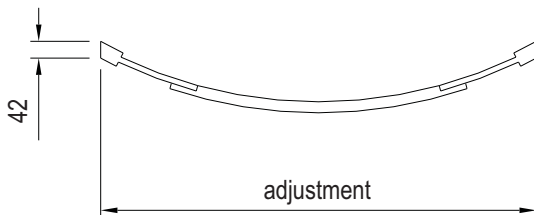

ADJUSTMENT mm			
PRODUCT SIZE	RECESS door only	CORNER door + 1 side panel	PENINSULAR door + 2 side panels
1200 Hinged / Slider	1170 - 1205	1172 - 1189	1174
1500 Slider	1470 - 1505	1472 - 1489	1474
1700 Slider	1655 - 1690	1657 - 1674	1659

**CURVED SLIDER ENCLOSURES**

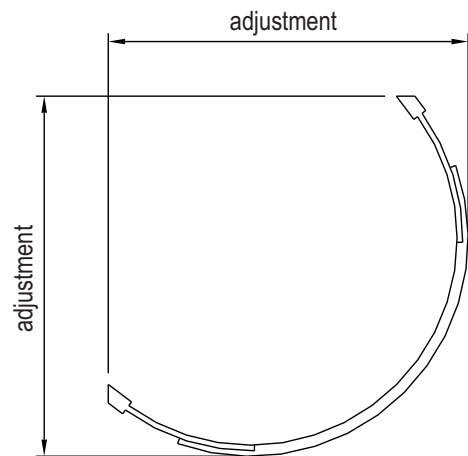

ADJUSTMENT mm	
PRODUCT SIZE	CORNER ENCLOSURE
910 Curved	880 - 897
1000 Curved	970 - 987
1000 Offset Curved	780 - 797 / 970 - 987
1200 Offset Curved	880 - 897 / 1170 - 1187

**1200 PENINSULAR SLIDER ENCLOSURE**

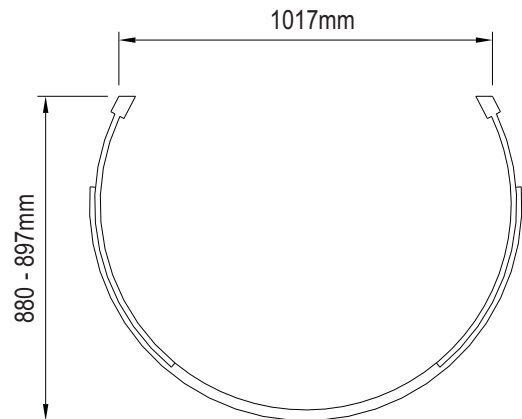

**ENCLOSURE PANELS**

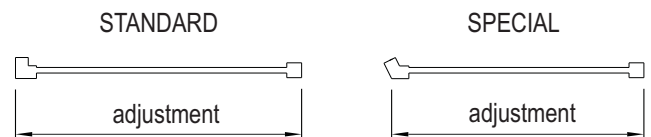

ADJUSTMENT mm	
PRODUCT SIZE	SIDE PANEL
700 Special Side Panel (Bowed Doors Only)	678 - 698
760 Standard Side Panel	731 - 751
800 Standard Side Panel	771 - 791
900 Standard Side Panel	871 - 891
1000 Standard Side Panel	971 - 991
1200 Standard Side Panel	1171 - 1191

PRODUCT Glass Panel (nominal size)	PRODUCT CODE	DIMENSIONS mm			
		A	B Actual Glass Width	C	D
600	5WP600	562 - 582	555	572 - 592	29
700	5WP700	662 - 682	655	672 - 692	29
760	5WP760	722 - 742	715	732 - 752	29
800	5WP800	762 - 782	755	772 - 792	29
900	5WP900	862 - 882	855	872 - 892	29
1000	5WP1000	962 - 982	955	972 - 992	29
1100	5WP1100	1062 - 1082	1055	1072 - 1092	29
1200	5WP1200	1162 - 1182	1155	1172 - 1192	29
1400	5WP1400	1362 - 1382	1355	1372 - 1392	29

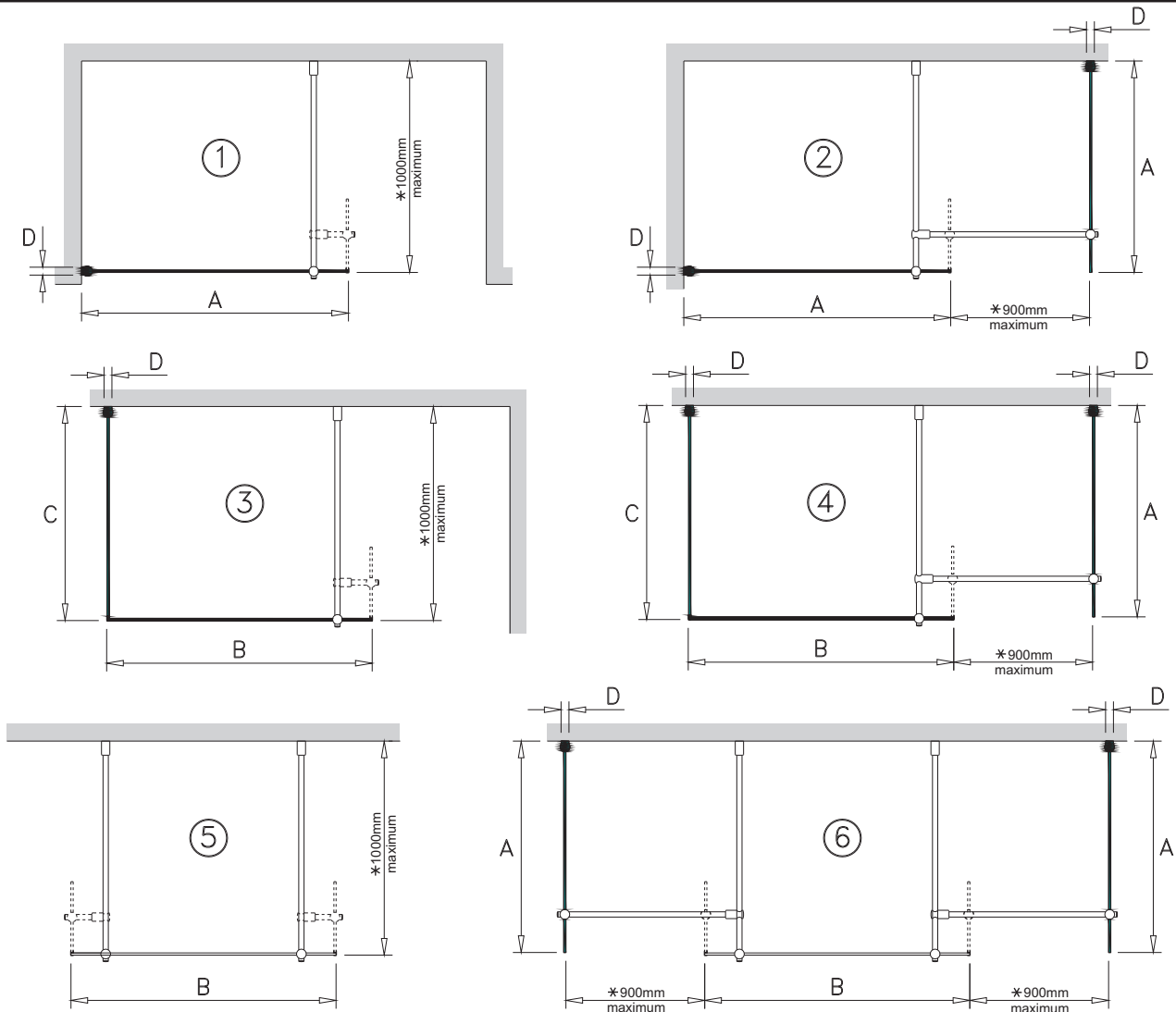

All panels are unhandled and can be installed to give left-hand and right-hand access.  
For clarity purposes, only right hand access configurations are shown, where applicable.

\* This dimension is based on using the standard 1000mm long stabiliser rail in the Front & Side Panel Component Packs.  
This dimension can be increased by a further 500mm by using the special 1500mm long stabiliser rail, 5WP1500SR, purchased separately through your retailer.

