

SS120 Hinged Panel Bathscreen

Installation & Maintenance instructions

Rev. 09.16

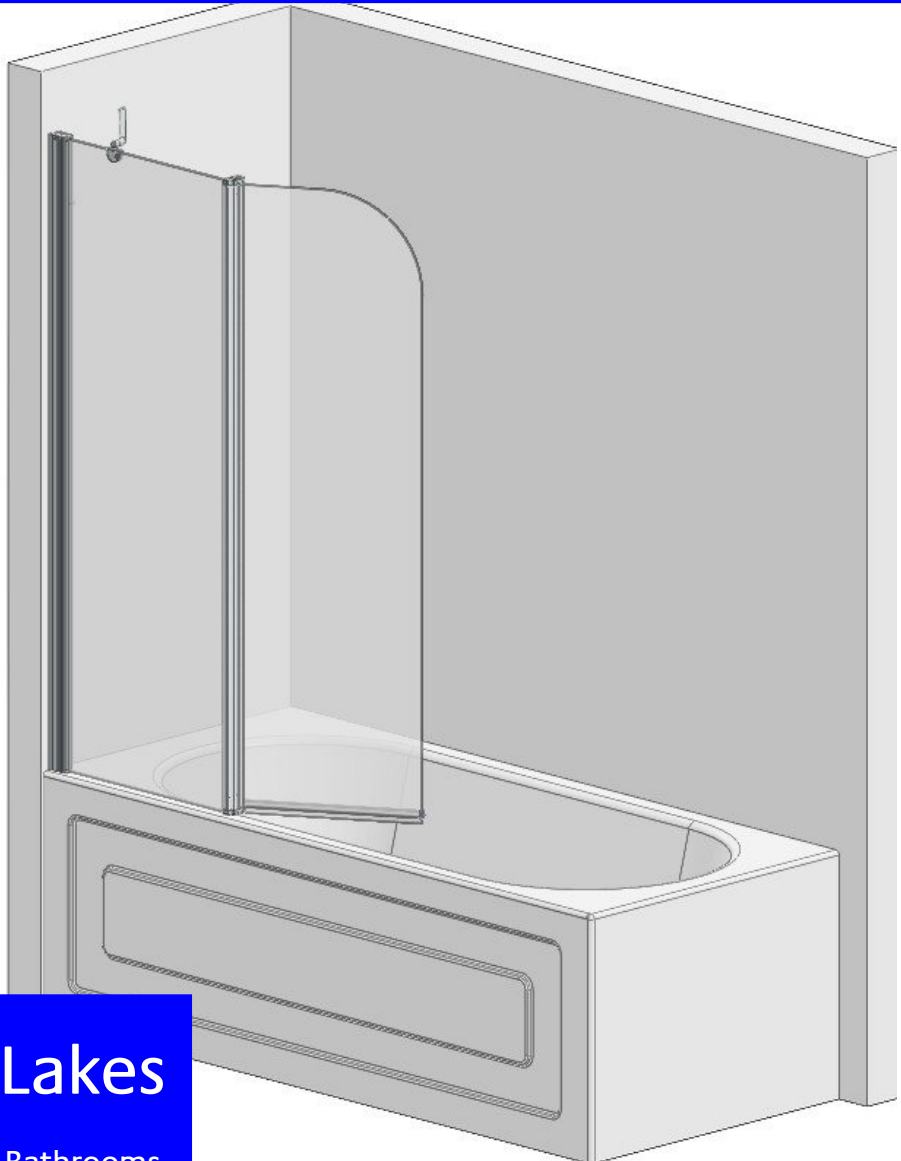

Lakes

Bathrooms

IMPORTANT NOTES :

Please Read Carefully & retain these instructions for Future Reference.

1. For ease & safety we advise that two persons assemble this product.
2. Protect bathtub surfaces at all times.
3. Check for cables, pipes etc before drilling walls.
4. Ensure all surfaces are dry, clean & free of loose debris / dust.
5. Unpack goods with care (small parts can become lodged in packaging & inadvertently discarded). Check parts supplied against parts & fittings listed herein. Damaged parts / omissions may be resolved by calling Lakes Bathrooms Helpline.
6. Whilst precautions are taken in manufacture, care must be taken when handling as rail ends may have sharp edges.
7. Before commencing, check :
 - a) bathtub is level & completely sealed to finished / tiled walls.
 - b) finished walls are sound & free of cracks loose tiles / grout.
8. AFTER INSTALLATION, DO NOT 'WET' ENCLOSURE FOR 48 HOURS (ENSURE FULL CURE OF SILICONE SEALANT).

USE :

General Care & Maintenance.

Provided this product is installed & operated in accordance with these instructions, problems should not arise. However should maintenance be required it should be carried out by a competent person with reference to these instructions. Before any work is carried out the root cause of the problem must be identified. Lakes Bathrooms service engineers are available if necessary to consult / carry out remedial work. Call Lakes Bathrooms HELPLINE.

Cleaning.

(Every one to two weeks depending on local water {hardness} conditions).

All glass panels in this product have a hydrophobic coating aiding 'runoff' of water droplets, reducing the need for frequent cleaning. For best appearance / product life however, regular cleaning is recommended.

Use ONLY mild soap / detergent solutions to clean. Rinse with water, squeegee glass panels & wipe frames dry with a soft cloth. Under no circumstances should abrasive, caustic or scouring products be used. DO NOT use 'spray & leave' type cleaning products.

Non compliance with these cleaning instructions may cause plated / painted finishes to deteriorate & could adversely affect safe operation of the enclosure.

Daily Care.

To prevent the build up of limescale, do not allow water droplets to dry on glass or frames. After showering, rinse with water, remove droplets from glass with a squeegee & wipe frame with a soft cloth.

Customer Service.

Quality Guarantee : Lakes Bathrooms Ltd guarantee Shower Doors & Enclosures against any manufacturing or material defects for the lifetime of the product. We will resolve defects free of charge by repairing / replacing parts as we feel necessary. To be 'free of charge' service work must be carried out by Lakes Bathrooms or approved agents.

Not Covered by this Guarantee : Damage or defects that result from improper installation, improper use, or lack of maintenance (including limescale buildup). Damage or defects that result from repairs / modifications undertaken by unauthorized persons. This guarantee is in addition to statutory & other legal rights.

What to do if something goes wrong : Should the product not function correctly on initial use, firstly, contact the installer to check that unit installation & commissioning are in accordance with these instructions. Should this not resolve difficulties or should performance decline, consult 'Troubleshooting' section to see if simple home maintenance is needed. Alternatively our HELPLINE staff can assist, or if necessary arrange for a service engineer to visit.

Spares : We maintain extensive spare part stocks. Spares can be ordered / purchased from your retailer in the first instance. Parts will normally be dispatched within two working days from order placement.

Pro Forma invoices will be sent for cheque payments.

Parts supplied:

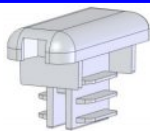

1x Top Plug

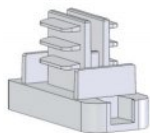

1x Bottom Plug



2x Glazing Gasket



2x Hinge Washer



2x Seal End Cap
(Handed Pair)



3x Wall Plug



3x 60mm M5 Screw



4x 30mm M4 screw



3x 10mm M3.5 Screw,
Washer & Cover cap

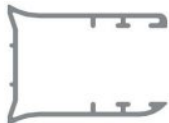

1x Wall Profile



2x Hinge (Handed
pair)

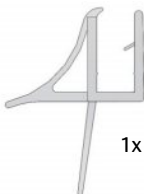

1x Bottom Seal



1x Hinge Seal

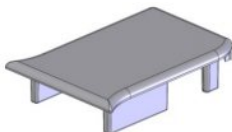

2x Wall Profile Cap
(Handed Pair)

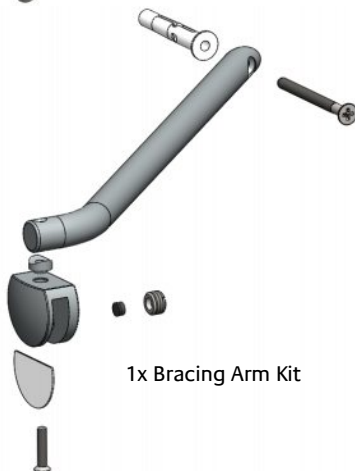

1x Bracing Arm Kit

Tools Required:



Spirit level with



Good quality silicone sealant and applicator



Power drill with 8mm



Pencil

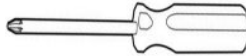

Pozidriv Screwdriver

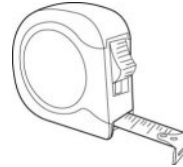

Tape measure



3mm HSS drill bit

Lakes fully reversible hinged panel bathscreen for fitting left or right handed to suitable bathtub. Ensure bath rim is level & that bath / wall (tile) joints are sealed & cured over entire length of bath sides as shown prior to fitting screen. **DO NOT SEAL BATH EDGES UP TO A FITTED SCREEN!**

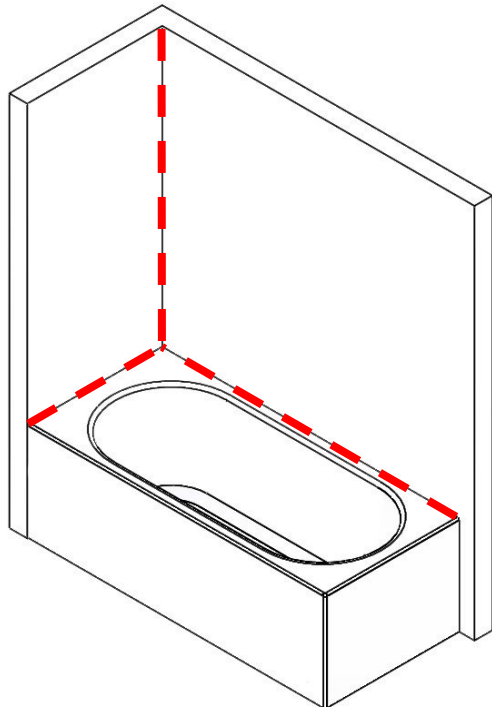

It is important to assess the fall of the bath rim and position the wall profile so that any water runs off into the bath and does not pool on the bath rim

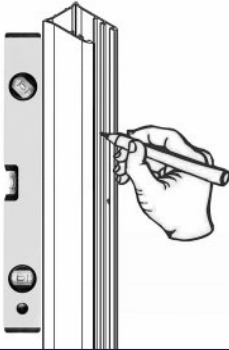
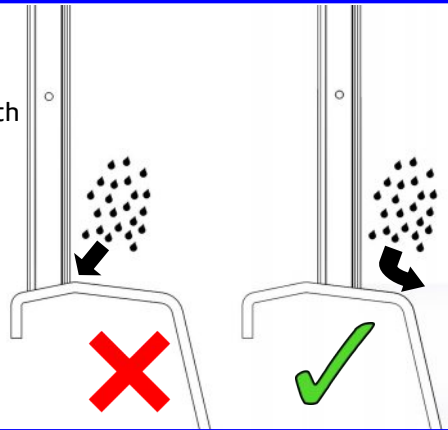

With the curved face of the wall profile facing outwards, use the spirit level to ensure wall profile is plumb, mark screw holes then drill the wall with the 8mm masonry bit, plug and affix the wall profile using 3x 60mm M5 screws

Determine the hand of the screen and insert the top & bottom plugs into the glass profile and making sure the glass gasket is in place, affix the bottom hinge using 2 of the 30mm M4 screws.

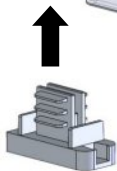
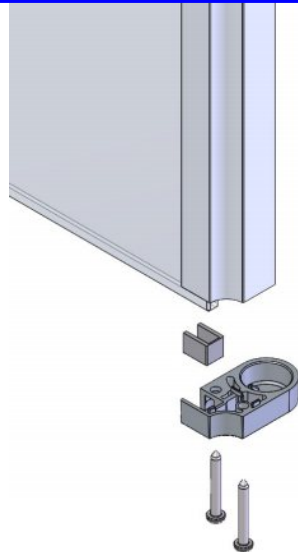

1

1. Fit the hinge seal into the groove on the hinge profile.

2. Slide the fixed panel assembly into the wall profile and position so that the bottom of the panel sits on the rim of the bathtub & is plumb.

2

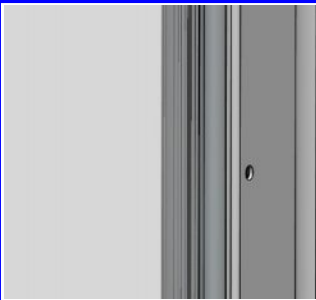
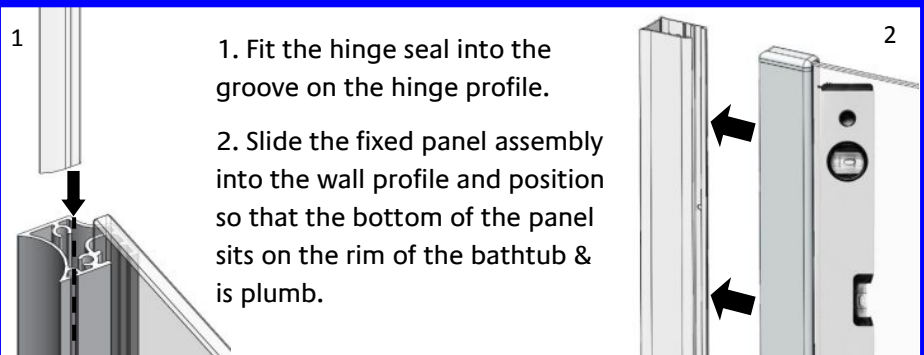

Using the wall profile holes as a guide, drill the 3mm holes and then secure the fixed panel using the 10mm M3.5 screws and washers then push on the cover caps.

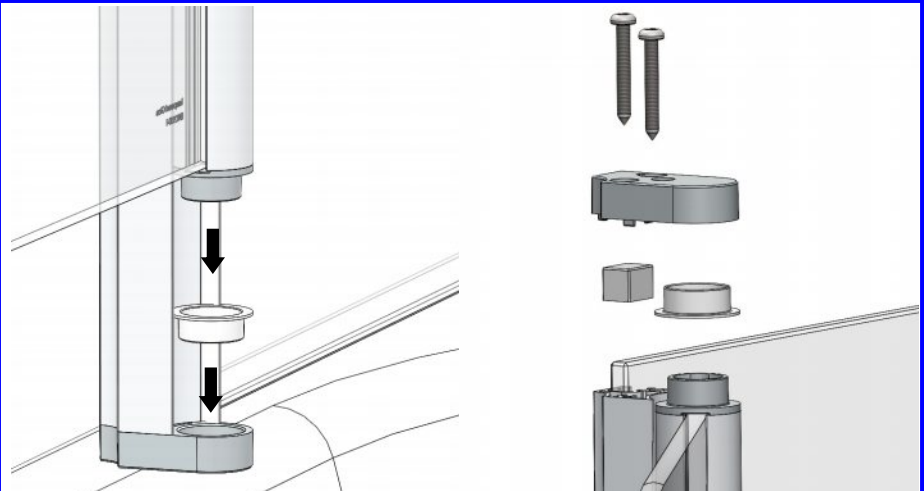

Ensuring the washer is in place, lower hinge panel into bottom hinge. Check glass gasket & top bearing washer are fitted as shown, hold panel upright in place & fit top hinge with 2x 30mm M4 screws.

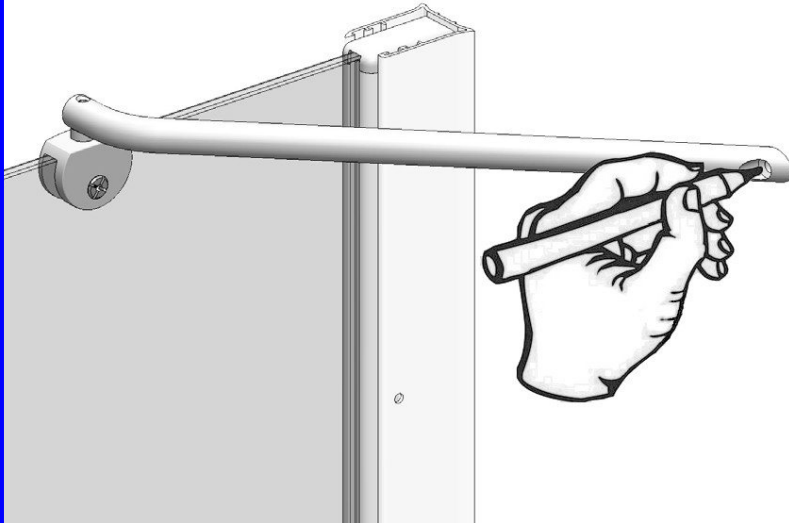

Loosen clamping screw then place bracing arm on glass as shown. Position arm so that the wall end sits flush with the wall the mark the hole position, drill (8mm), plug & affix to wall using 5mm x 60mm screw. Ensuring the gasket is in position in the bracing arm, tighten the clamping screw.

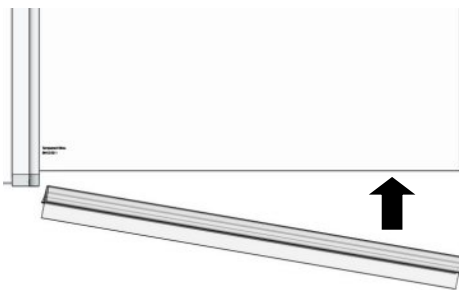

Fit the bottom seal to the hinge panel. Seal may be “wetted” to aid fitting.

Fit end cap to end of seal.
A small blob of silicone can be used to secure cap.

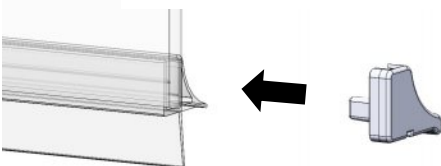

Fit wall profile top cap

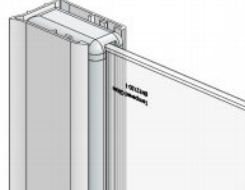

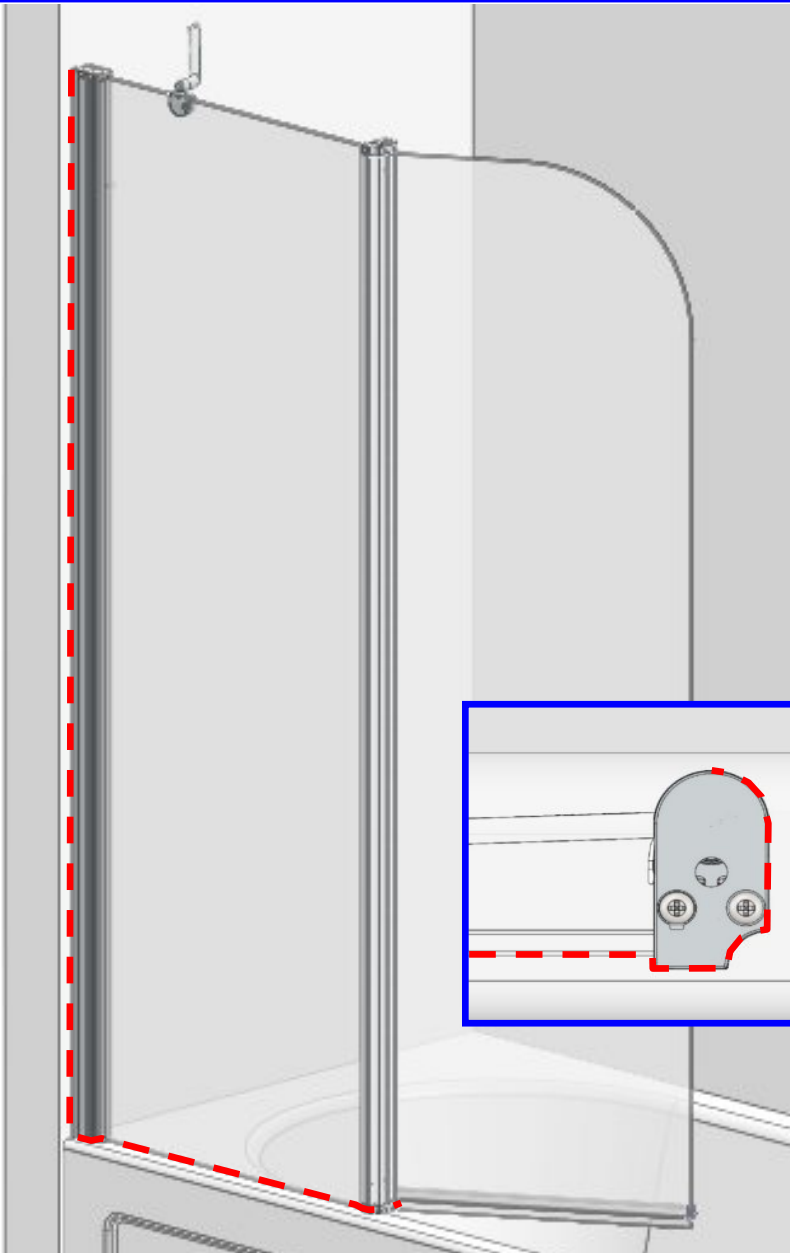

Use of good quality silicone sealant & cleaning / degreasing of all joint areas is recommended.

Apply continuous silicone sealant bead as indicated EXTERNALLY ONLY

BASIC TROUBLESHOOTING :

Screen hinges noisy / not moving smoothly : Apply sanitary silicone based grease to hinge bearing inner diameters. Check that hinge seal is not distorted or trapped in gap between profiles.

Leakage in area of bottom hinge : ensure bottom seal is pushed fully up to bottom hinge.

Water pooling on inside of screen :

Check 'fall' of bath rim is toward bathing area (certain bathtubs are unsuitable for screens of this type).

Leakage :

The sealing method described in these instructions relies on a continuous seal between walls & bathtub before installing the screen (see fig A), & positioning of the screen inside the 'high' point of the rim, then ensures a watertight seal around the perimeter, & prevents 'pooling' against the screen. Should 'pooling' be a problem it is likely due to incorrect screen / rim positioning. In the unlikely event of a screen leak, water will be visible on the outside of the screen itself or around the perimeter silicone seal ONLY. Water / moisture appearing outside this area (ie at floor level, or under bathtub) is normally due to incorrect bathtub / screen sealing.

Lakes Bathrooms Ltd

Alexandra Way
Ashchurch
Tewkesbury
Gloucestershire GL20 8NB

Service England, Scotland, Wales.

8.30am—5pm Mon ~ Thurs

8.30am—4.30pm Fri

Tel / HELPLINE : 01684 853870

Fax : 01684 857411

www.lakesbathrooms.co.uk

Email : admin@lakesbathrooms.co.uk

Service : Northern Ireland

Ian A Kernohan

Firtrees
Green Way Industrial Estate
Conlig

Northern Ireland BT23 7SU

8.30am—5pm Mon ~ Thurs

8.30am—4.30pm Fri

Tel : 02891 270233

Fax : 02891 270597

Email : info@iakonline.com