

90mm Shower Waste Installation & Assembly Instruction

1. Trap Assembly

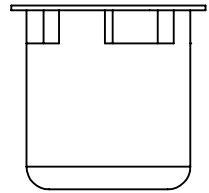
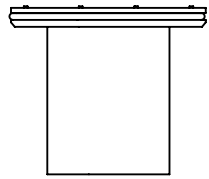
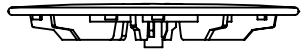

This waste provides a flow rate greater than 32L per minute when tested in accordance with EN274-2:2002. The flow rate can be seriously impaired if an adequate fall is not maintained throughout the length of the waste pipe.

Install the trap into the shower tray by assembling A, B, C & D as illustrated.

Connect the trap outlet (D) to waste pipe ensuring that the pipe is adequately supported. Test the installation.

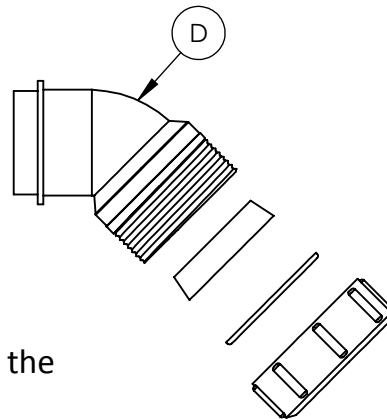
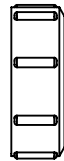
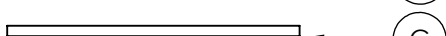
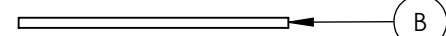
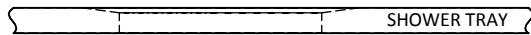
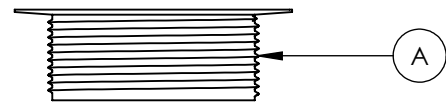

Please Note: The order and position of the sealing washer (B). Failure to do so can result in water leakage.

2. Trap Fitting

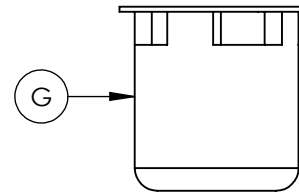
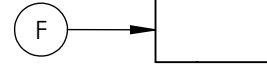
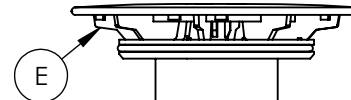

Insert the cup and trap (F&G). Push down firmly to ensure the trap is in the the bottom position.

Note: If silicone sealant is used, it should be a neutral sealant and not an acetoxy sealant.

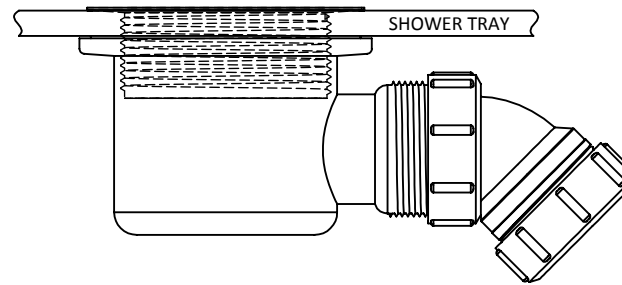

3. Completed Assembly

After Care: Regular maintainance is essentail to retaining a high performance flow rate. Remove flange (E) and trap assembly (F&G) and thoroughly clean all the parts. Flush through the trap body with clean water and carefully replace the parts.

