

Installation Manual

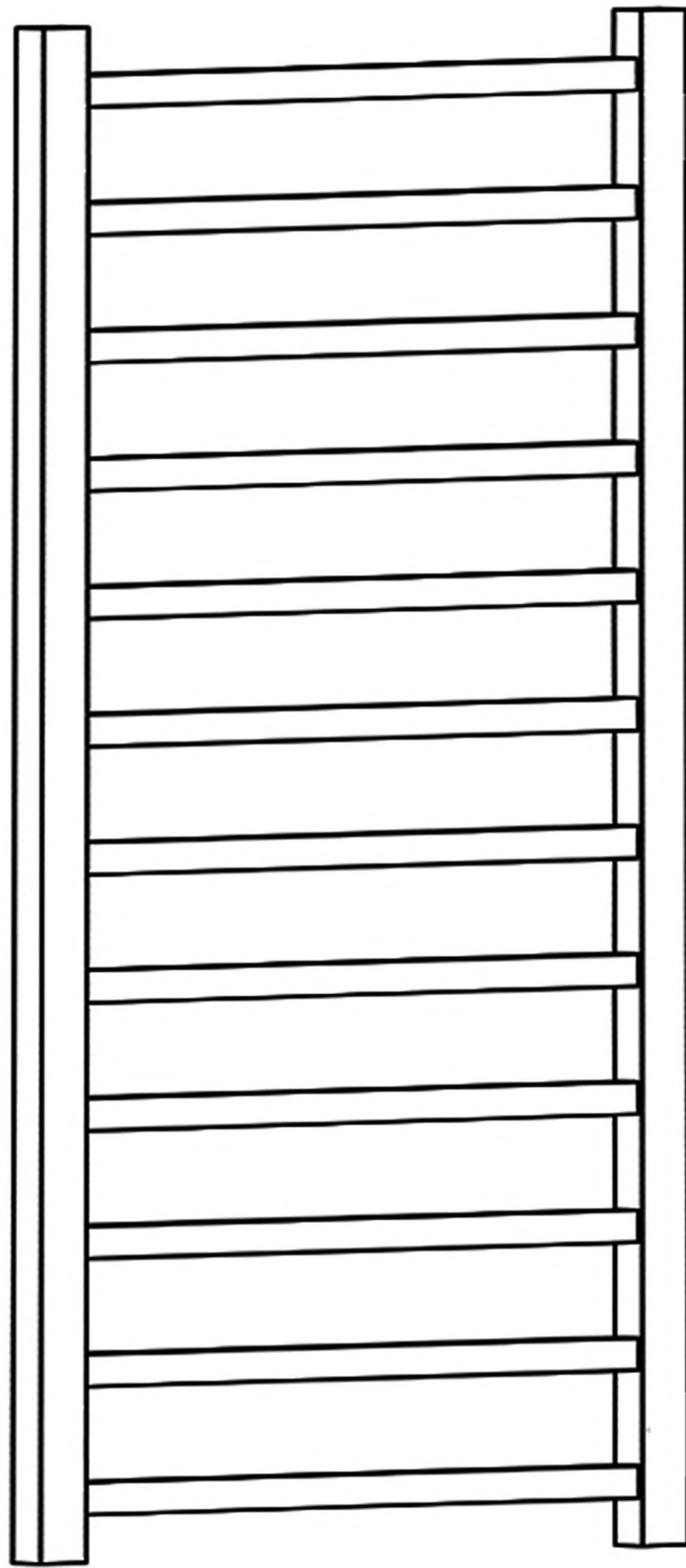

Please keep these instructions for future reference.

NO. IS0306005V1.2



WARNING



CAUTION

1. Follow installation instructions carefully to ensure unit is properly attached to the wall.
2. To avoid a possible fire hazard, it is essential unit is mounted in accordance with guidelines stated in the instruction.
3. Radiator is intended for indoor use only, do not place radiator inside a shower, steam room, or wherever unit would be exposed to water.

IMPORTANT CHILD SAFETY NOTE

Important: Please note that you are 100% legally responsible for your own child's safety at home. Once the radiator is installed, it can become a hazard for children as a) This radiator is not designed to support unreasonable extra weight, such as that of a child, and b) The radiator becomes hot during use. Due to this, we must stress that you should not allow children to climb/grab/play with the radiator or rails, as this can cause accident or injury for the child, from heat, falling, or the radiator being pulled off the wall.

TOOLS YOU MIGHT NEED



Adjustable Wrench

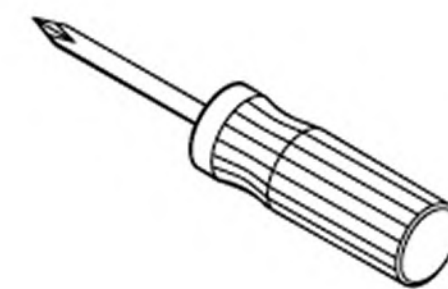

Screwdriver



Electric Drill



Pencil



Spirit Level

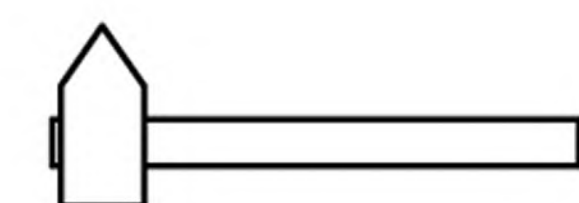

Rubber Hammer



Tape Measure

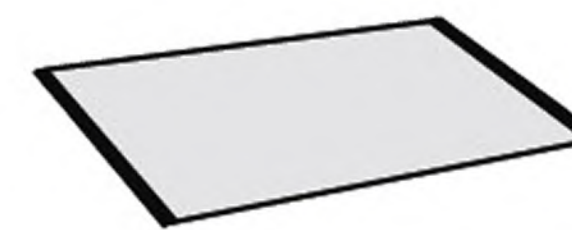

Clean cloth



Glove

TECHNICAL DATA

It should only be filled with water, and at a temperature below 100°C (212°F). See table below for installation requirements. If the temperature exceeds 48°C (or 120°F), please install a warning sign near the product to avoid burning and scolding accidents.

Temperature: $0^{\circ}\text{C} < t \leq 100^{\circ}\text{C}$

Comments: If ambient temperature drops below 1°C, drain out the water to prevent freezing.

Important







Wipe the surface clean with a soft, damp cloth. Never use abrasive cleaners on this product as they will damage the surface.

BEFORE INSTALLATION

- # Observe all local plumbing and building codes.
- # Shut off the main water supply.
- # Read these instructions carefully to ensure proper installation.
- # Check to make sure you have the following parts indicated below.

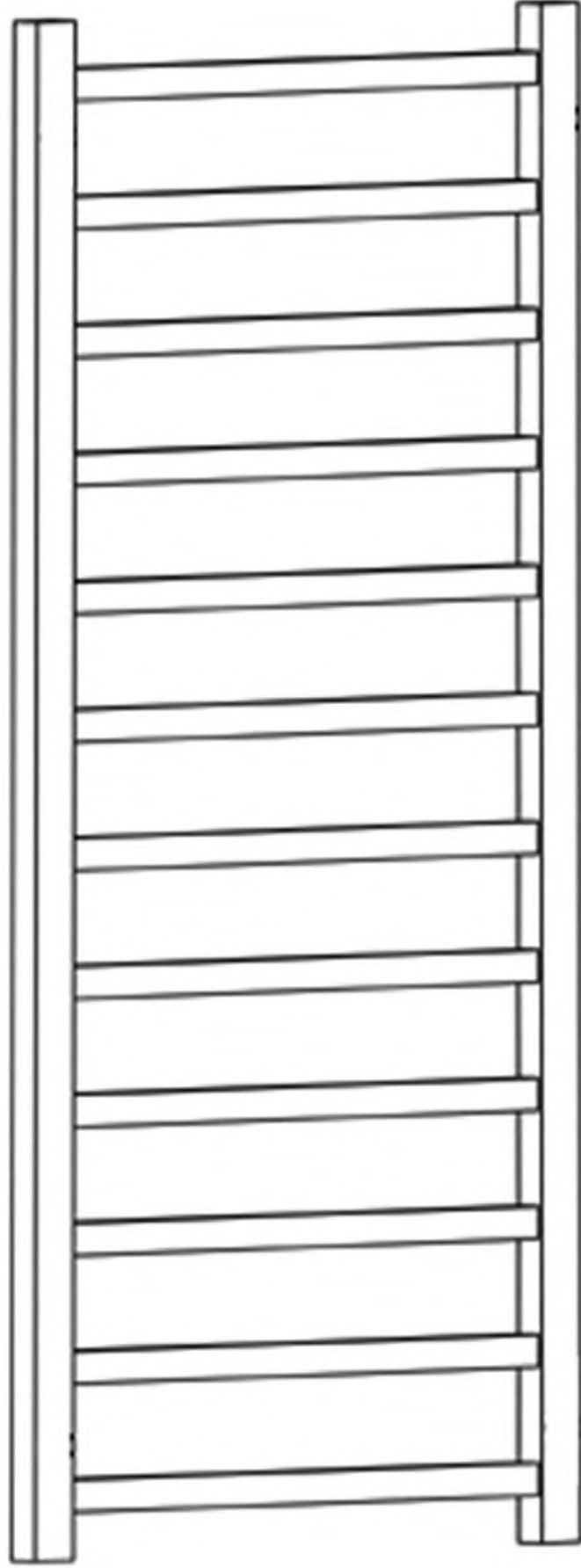
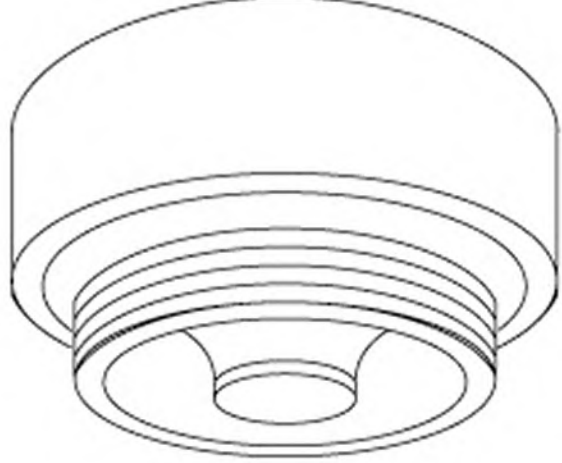
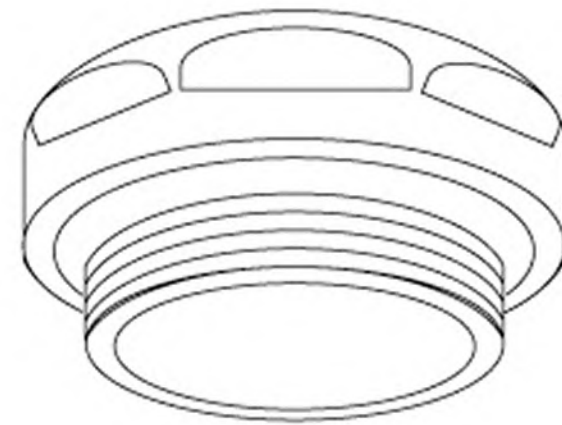
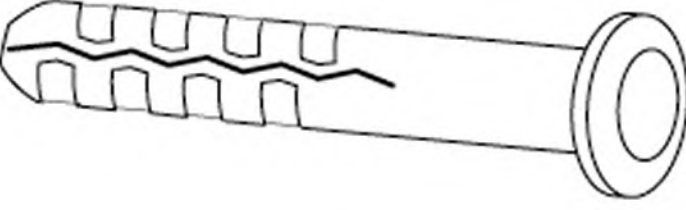

Please check you have all of these items in the box.

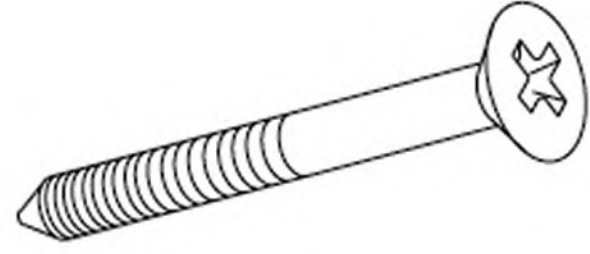
| | | | |
|---|---|---|--|
|  Wall Support X4 |  Bracket Body X4 |  Long Screw X4 |  Short Screw X4 |
|  Body X1 |  Airvent X1 |  Blanking plug X1 | |
| |  Wall plug X4 |  Washer X2 |  Long Screw X4 |

Required parts

- Option1: Thermostatic heating element(1pcs)+ Blanking plug(1pcs)+ Thermostatic controller(1pcs)
- Option2: Heating element(1pcs)+ Blanking plug(1pcs)
- Option3: Valve(2pcs)
- Option4 : Valves,T-piece,element and or thermostat and element(FOR DUAL FUEL OPTION)

INSTALLATION PROCEDURE

1

Assemble the 4 long screws & bracket bodies to towel radiator as below image.

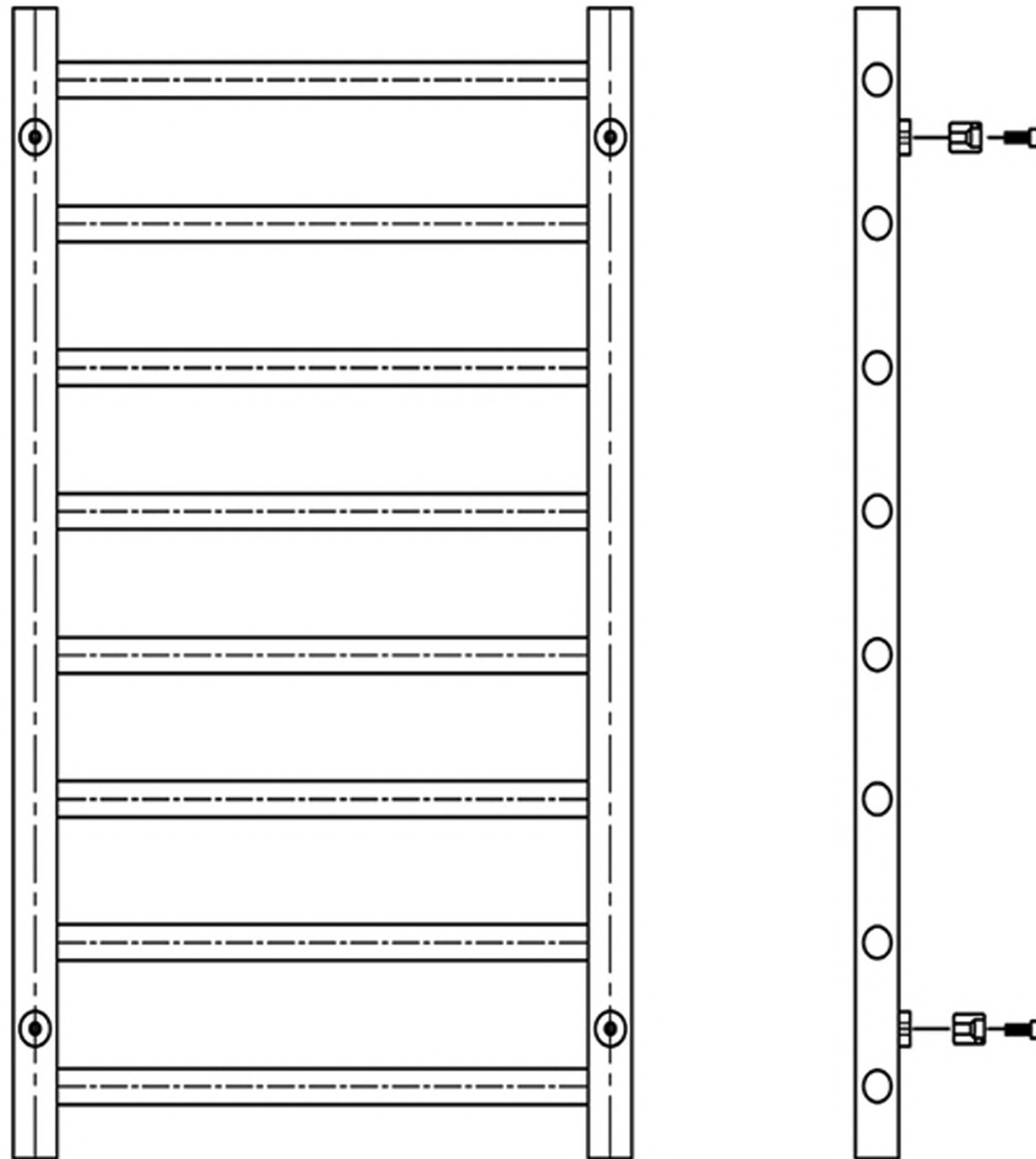

INSTALLATION PROCEDURE

2 Position the towel rail in desired location. Check for level and mark four equal positions for the brackets.

 Make sure the towel rail is installed vertically.

 Before installation place a dust sheet on the floor to prevent losing any small parts.

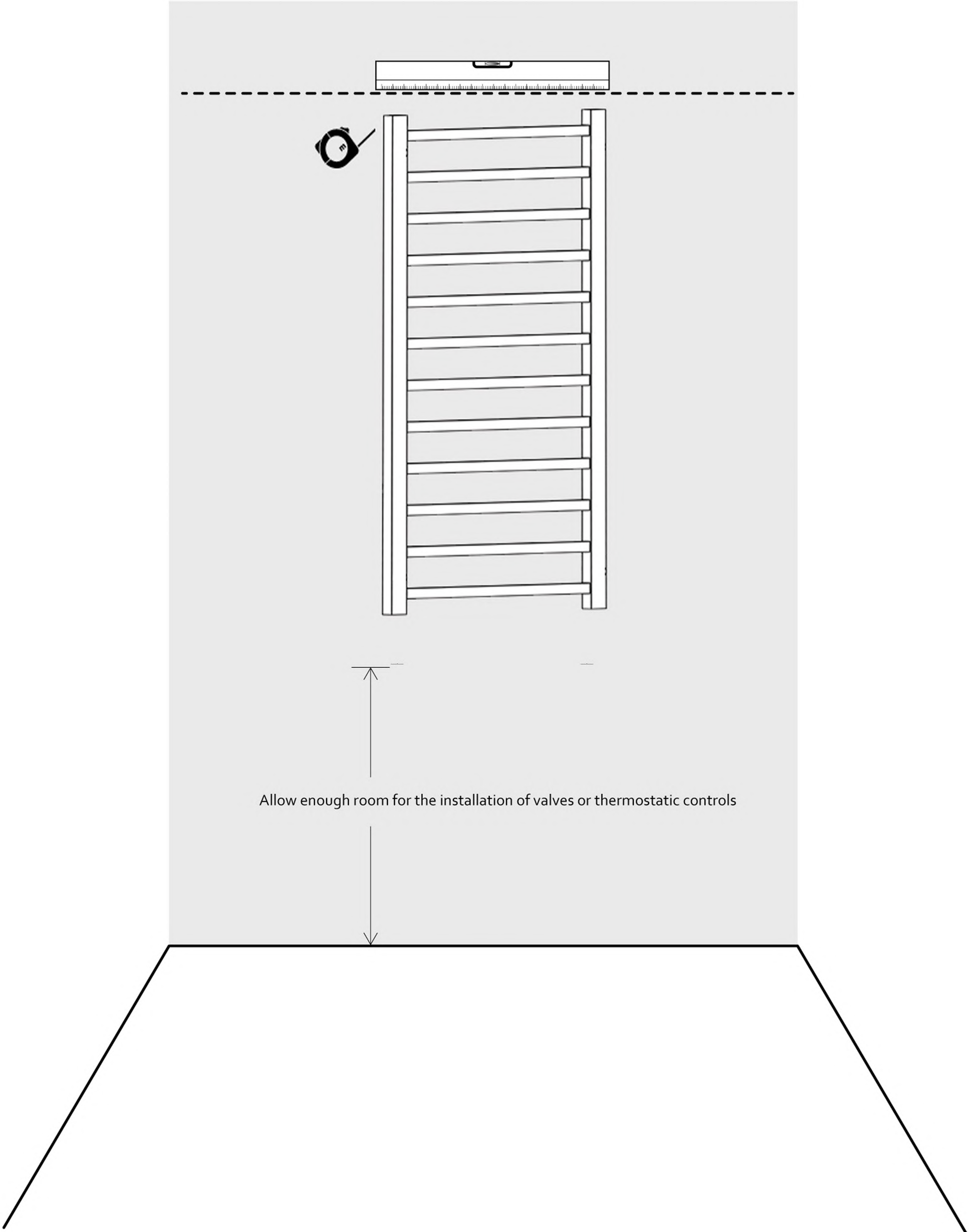

INSTALLATION PROCEDURE

3

Drill holes in wall and insert wall plugs.
N.B For false or studed walls different fixings can be purchased from your local DIY store.

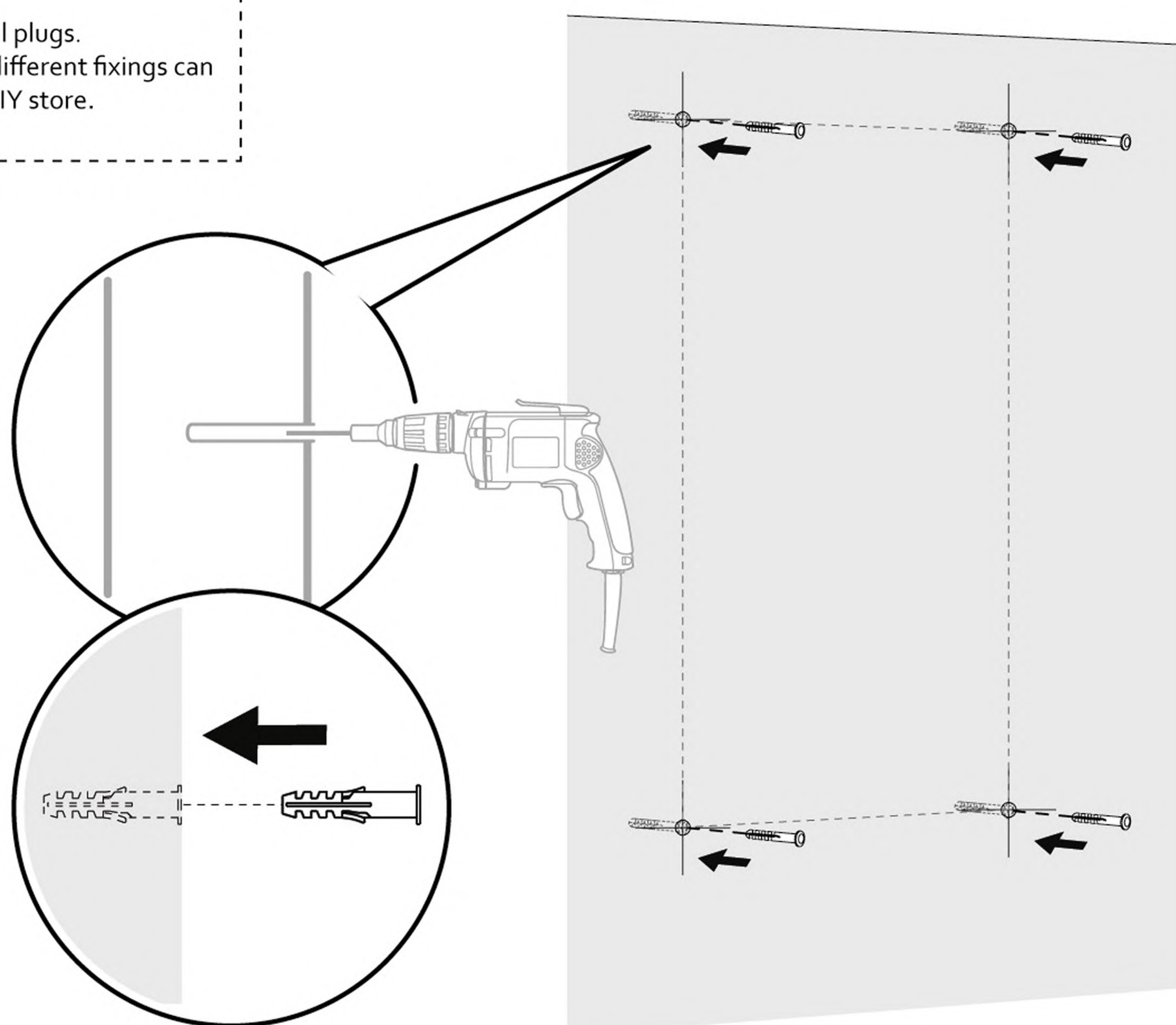

4

Fix all the wall supports to the wall as below image by using a screw driver

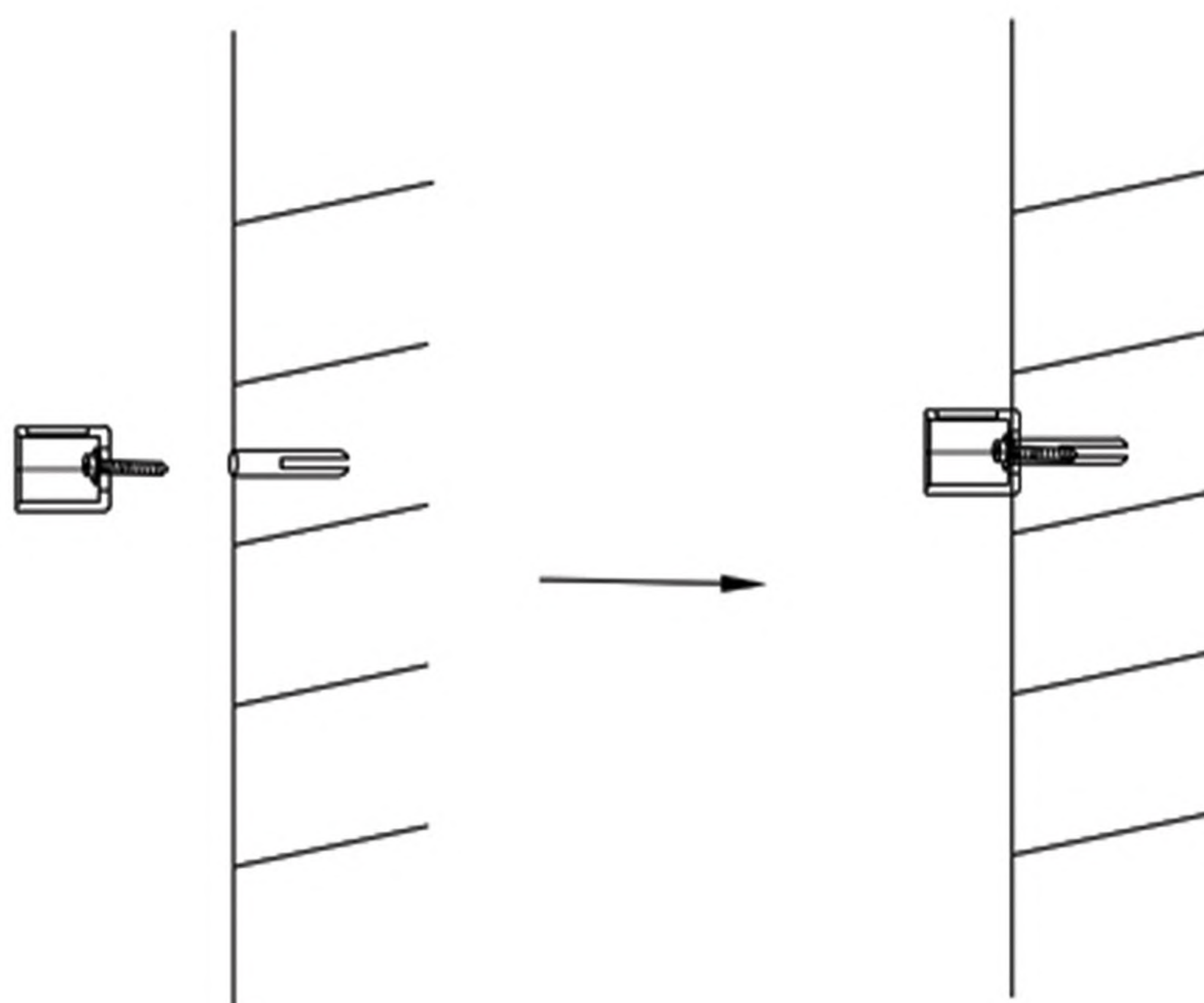

INSTALLATION PROCEDURE

5 Wrap PTFE tape around the blanking plug and bleed valve threads insert into the top of the radiator tighten with spanner.

! Before starting place a dust sheet on the ground to prevent damage and any spillage.

! Please ignore the following step if you are installing the radiator onto your central heating system.

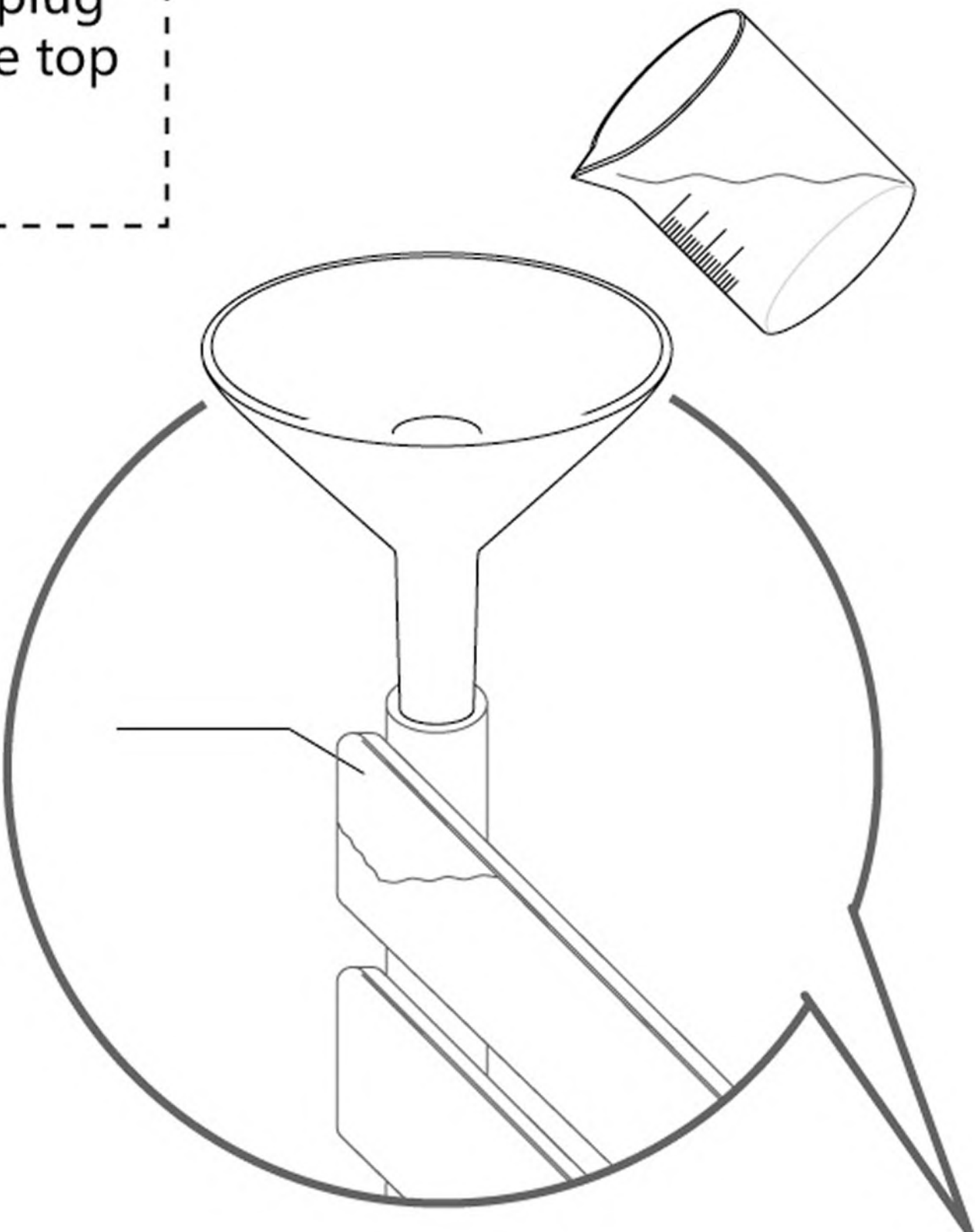

Turn radiator upside down and fill with a combination of water and a rust inhibitor 90% water 5% inhibitor allow 5% air for expansion.

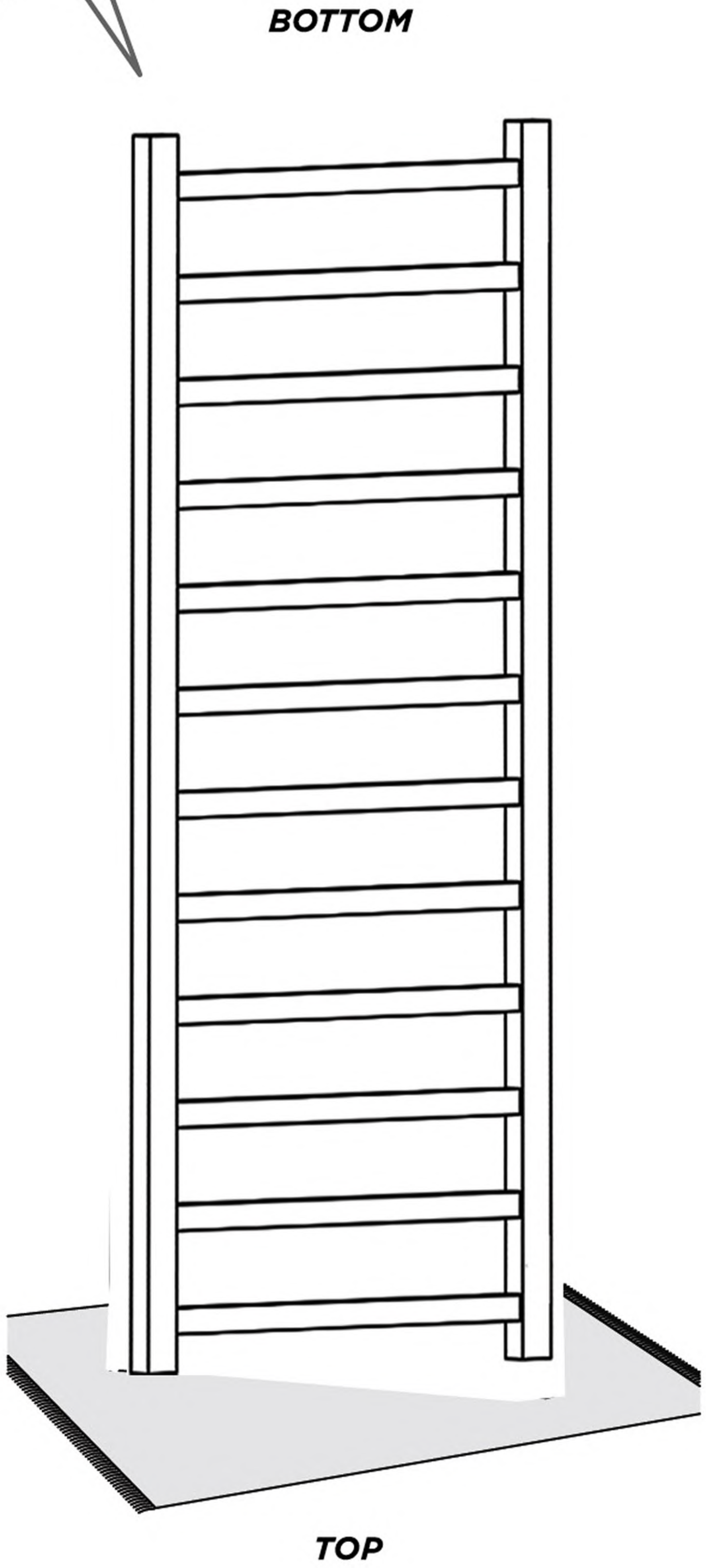
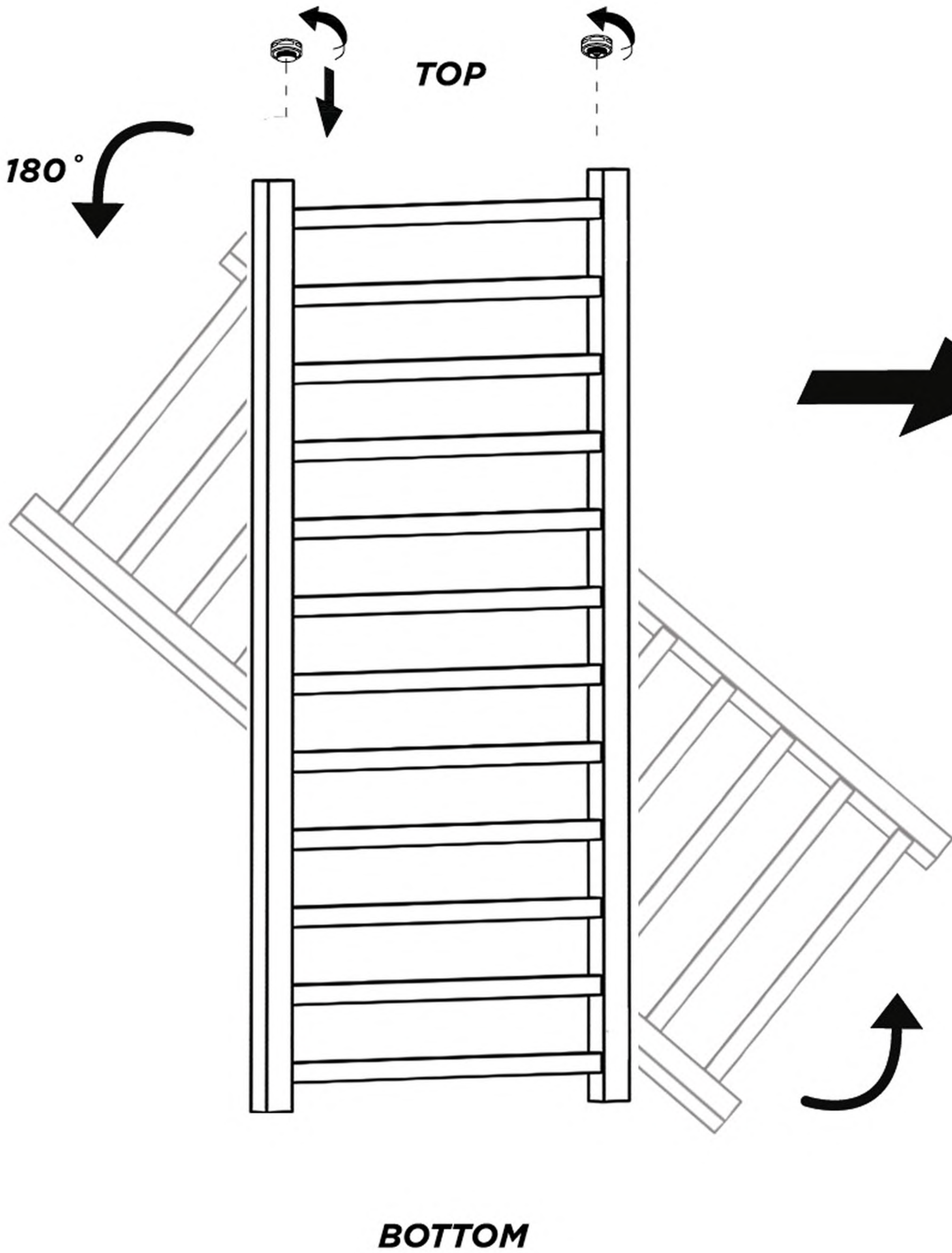

INSTALLATION PROCEDURE

Option1 Thermostatic Heating Element

6 Wrap PTFE tape around the blanking plug and element threads insert into the bottom of the radiator and tighten with spanner.

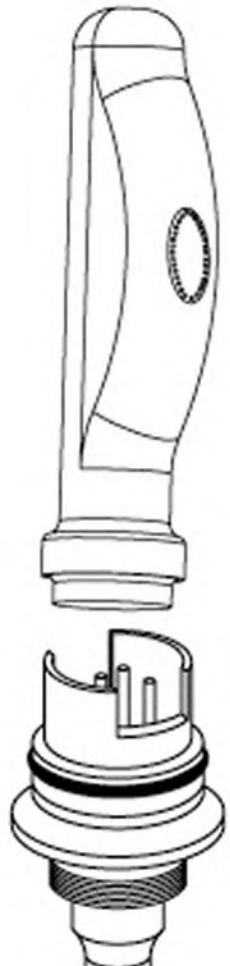

6a push on the thermostat and lock into place

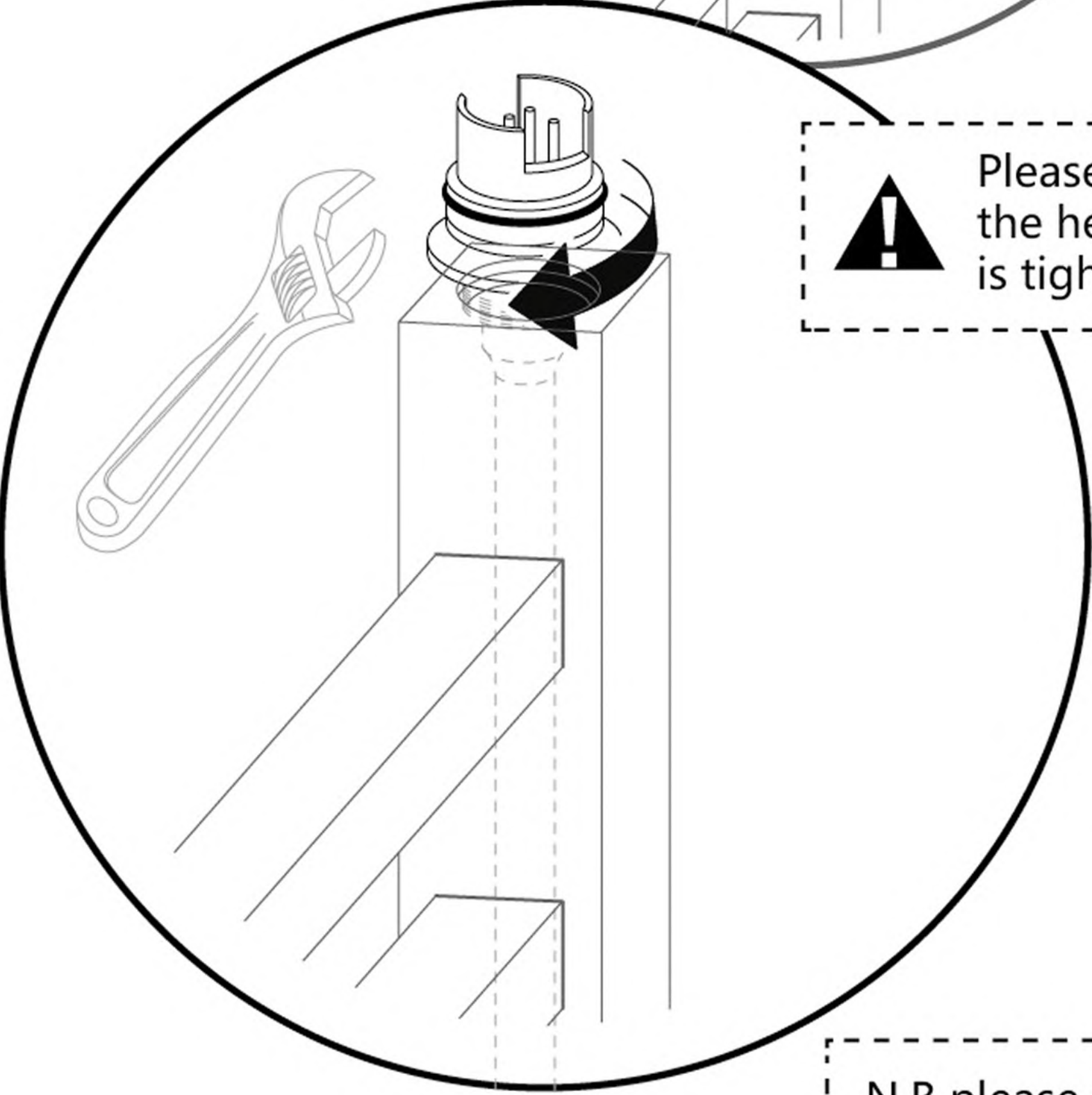
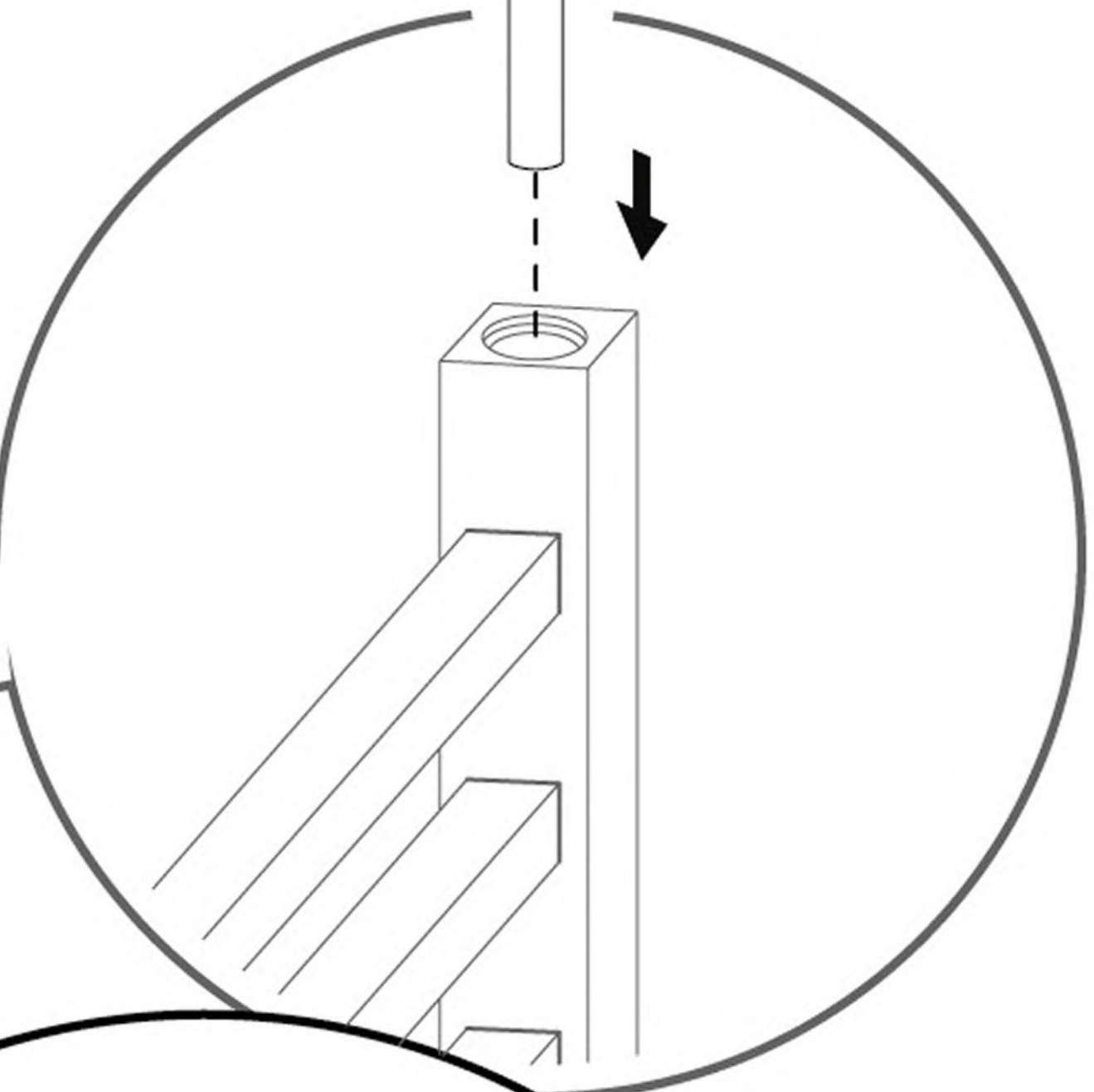
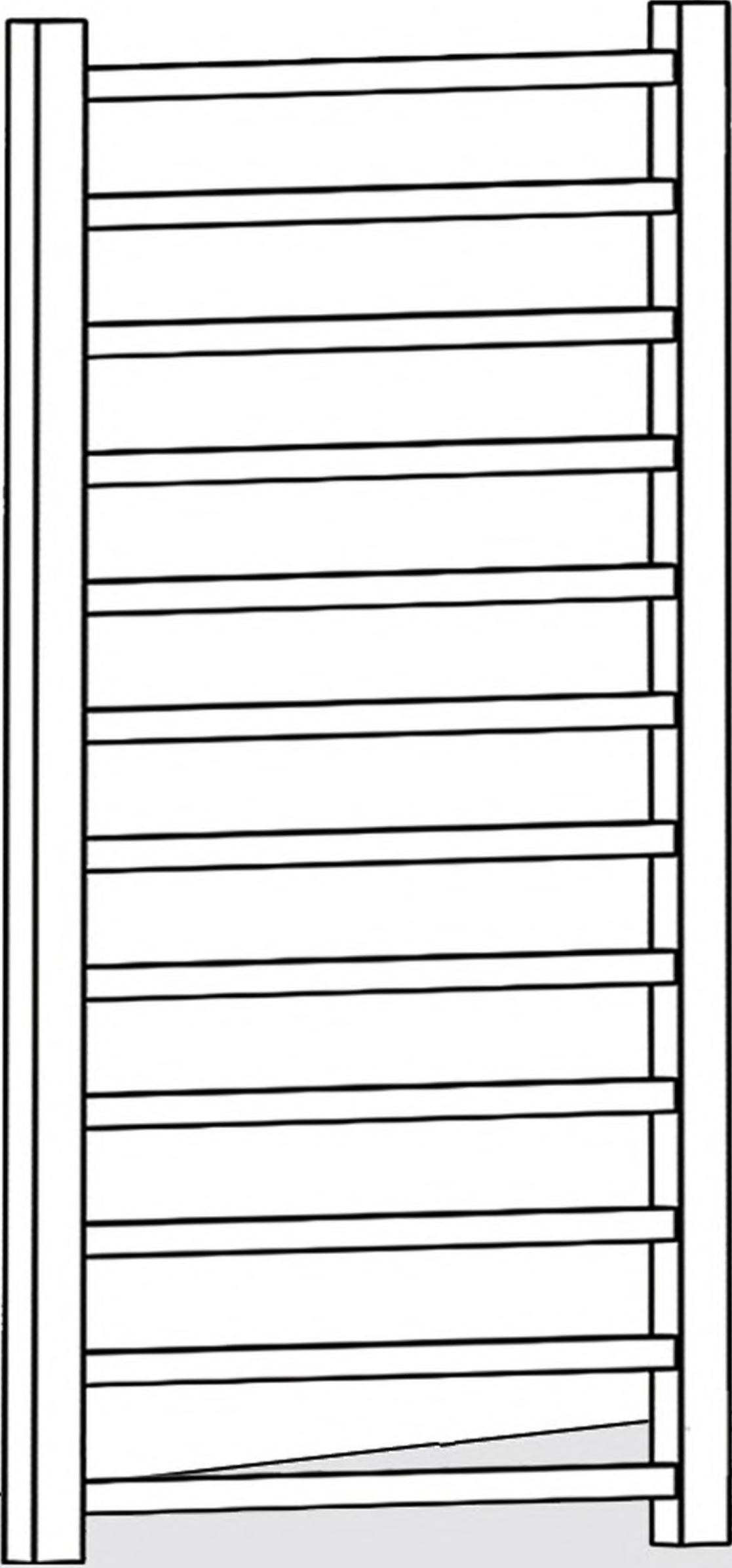

! Please make sure the heating element is tightened securely.

N.B please note the electrical wiring must be carried out by a qualified tradesperson.

INSTALLATION PROCEDURE

Option2 Heating Element

6 Wrap PTFE tape around the blanking plug and element threads insert into the bottom of the radiator and tighten with spanner.



Please make sure the heating element is tightened securely.

N.B please note the electrical wiring must be carried out by a qualified tradesperson.

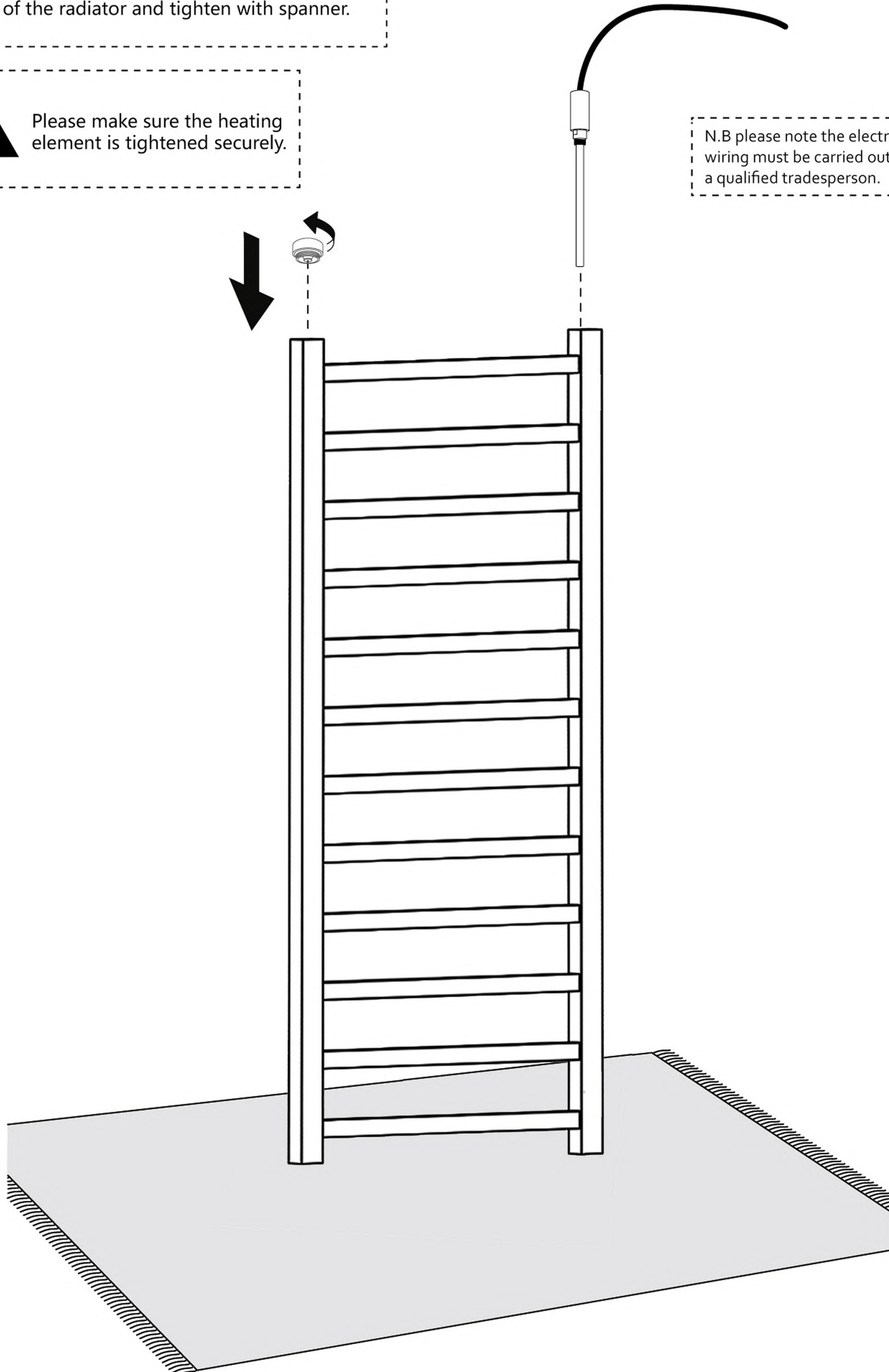

INSTALLATION PROCEDURE

Option3 Valve

6 Wrap PTFE tape around the blanking plug and element threads insert into the bottom of the radiator and connect to household supply.

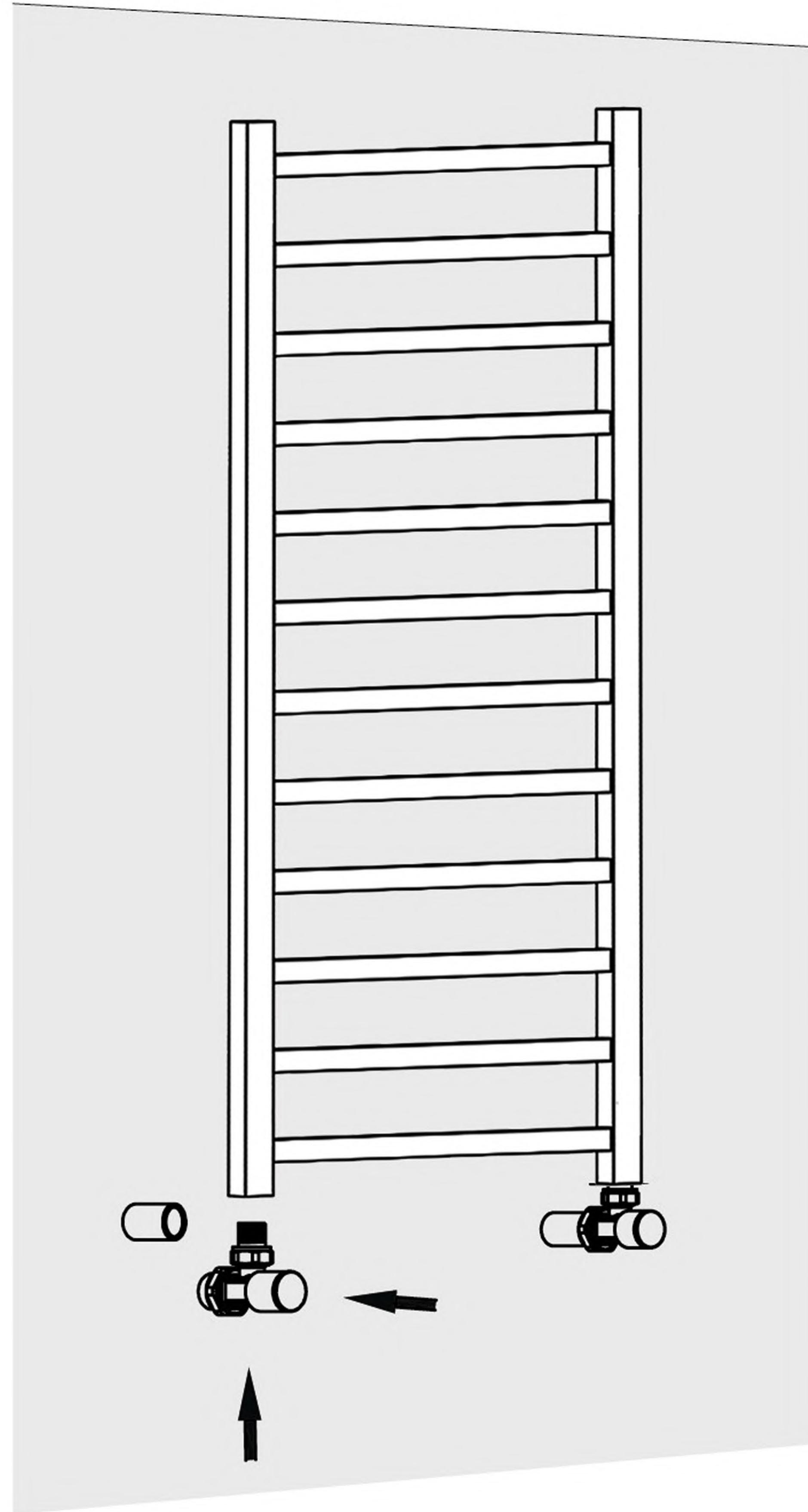

INSTALLATION PROCEDURE

Option4 Dual fuel

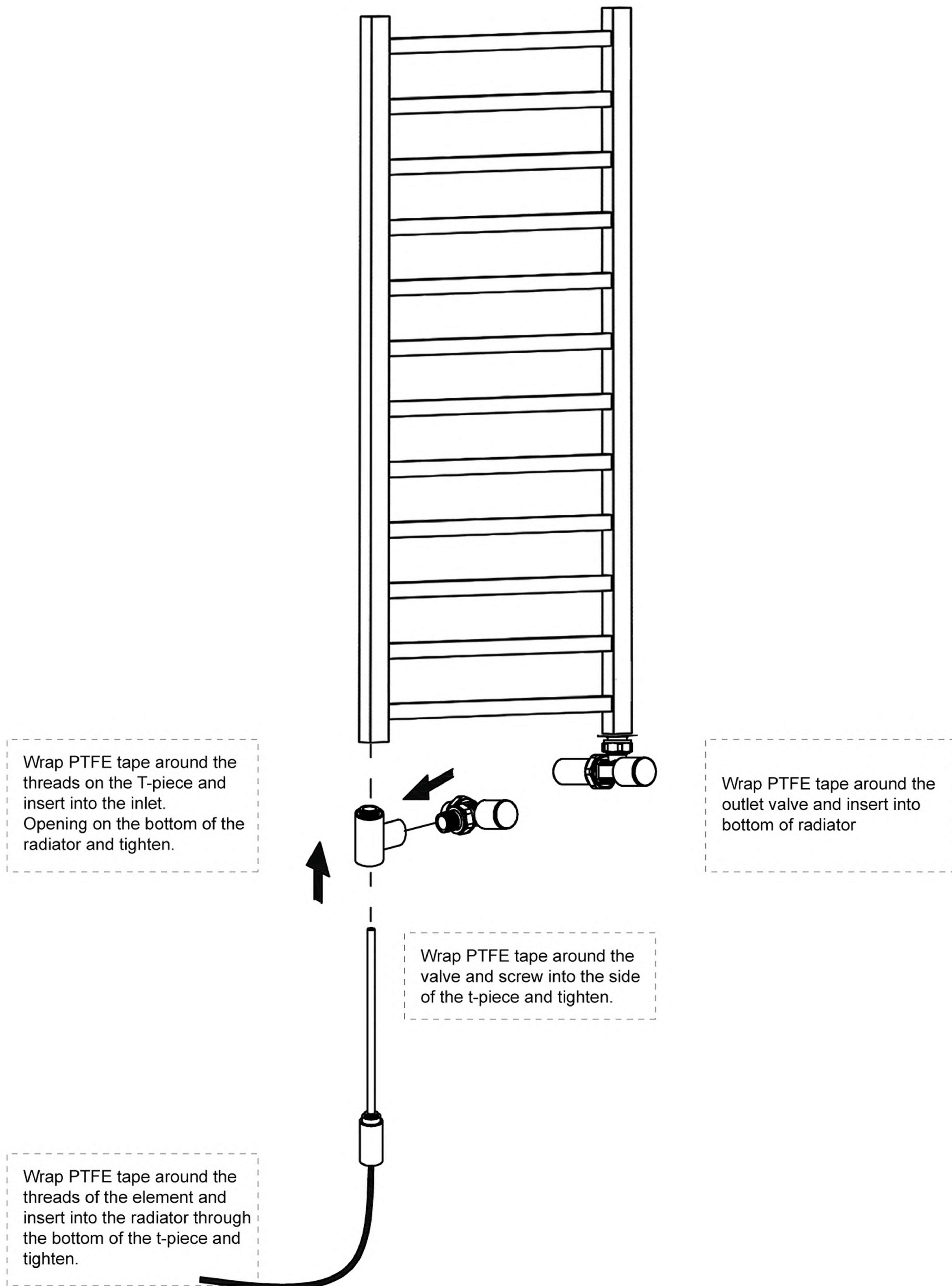

INSTALLATION PROCEDURE

- 7 Slide the brackets into the wall supports and tighten all the screws when in the desired location.

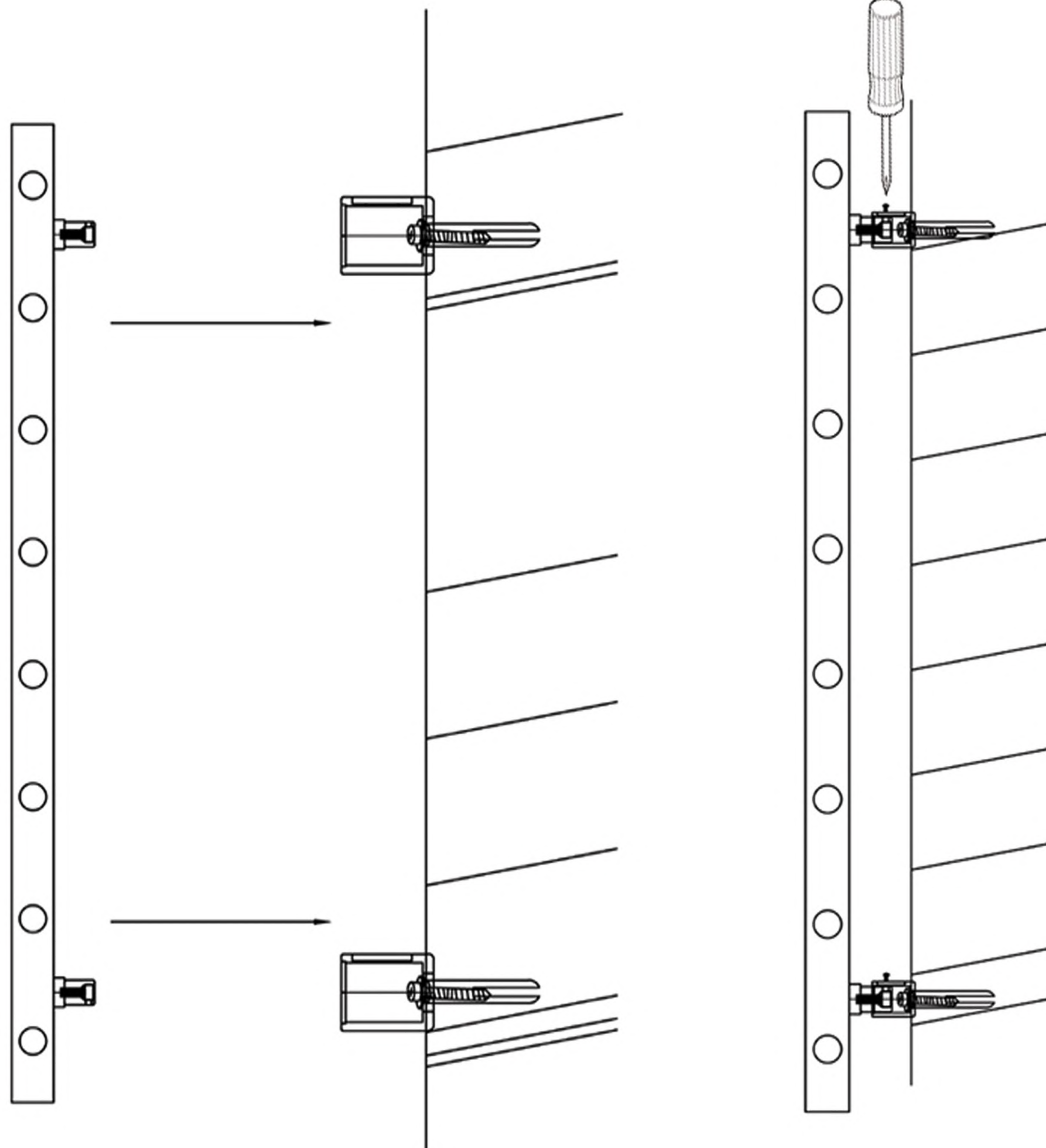

INSTALLATION PROCEDURE

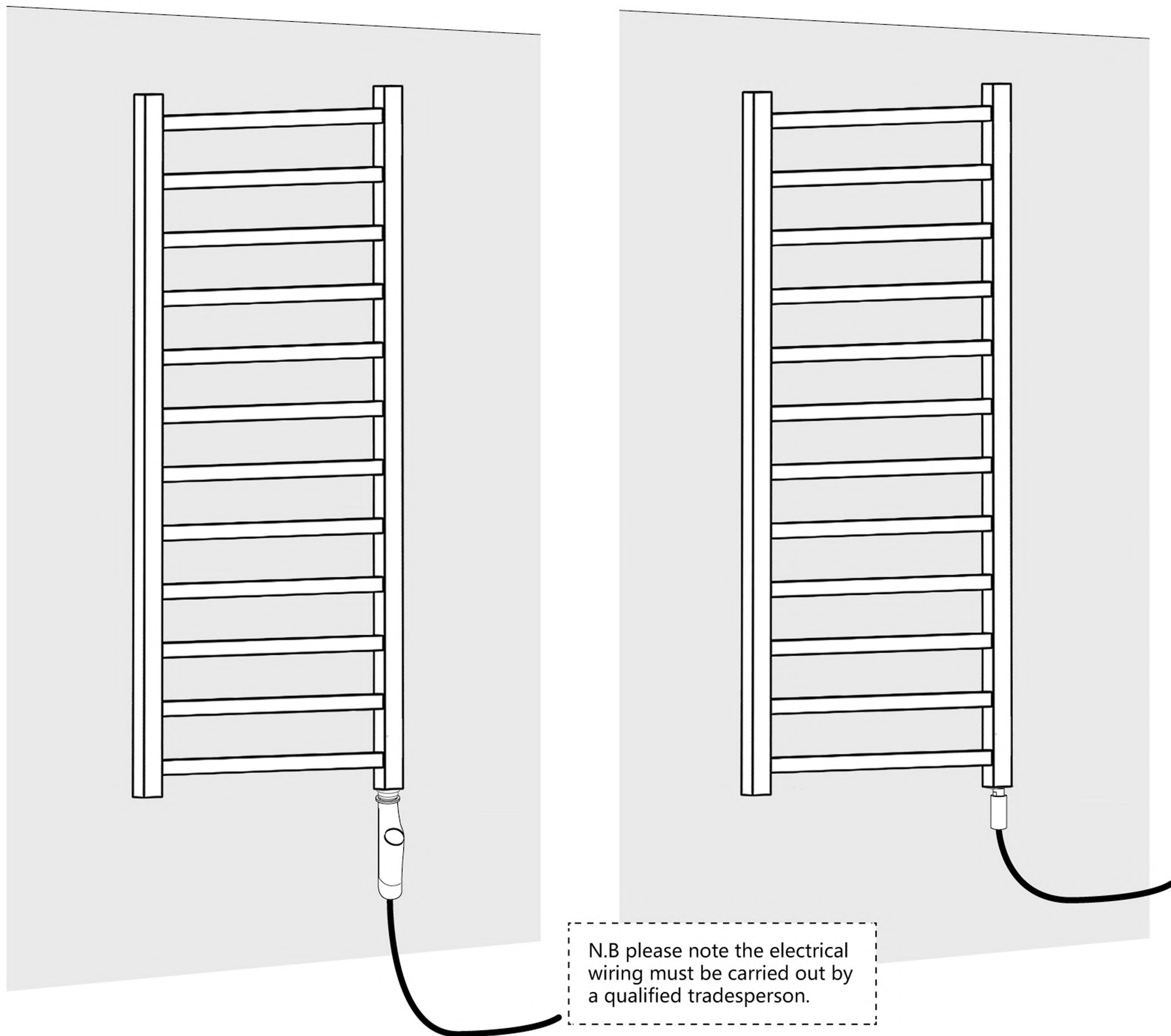

Option1 Thermostatic Heating Element

Option2 Heating Element

Option3 Valve

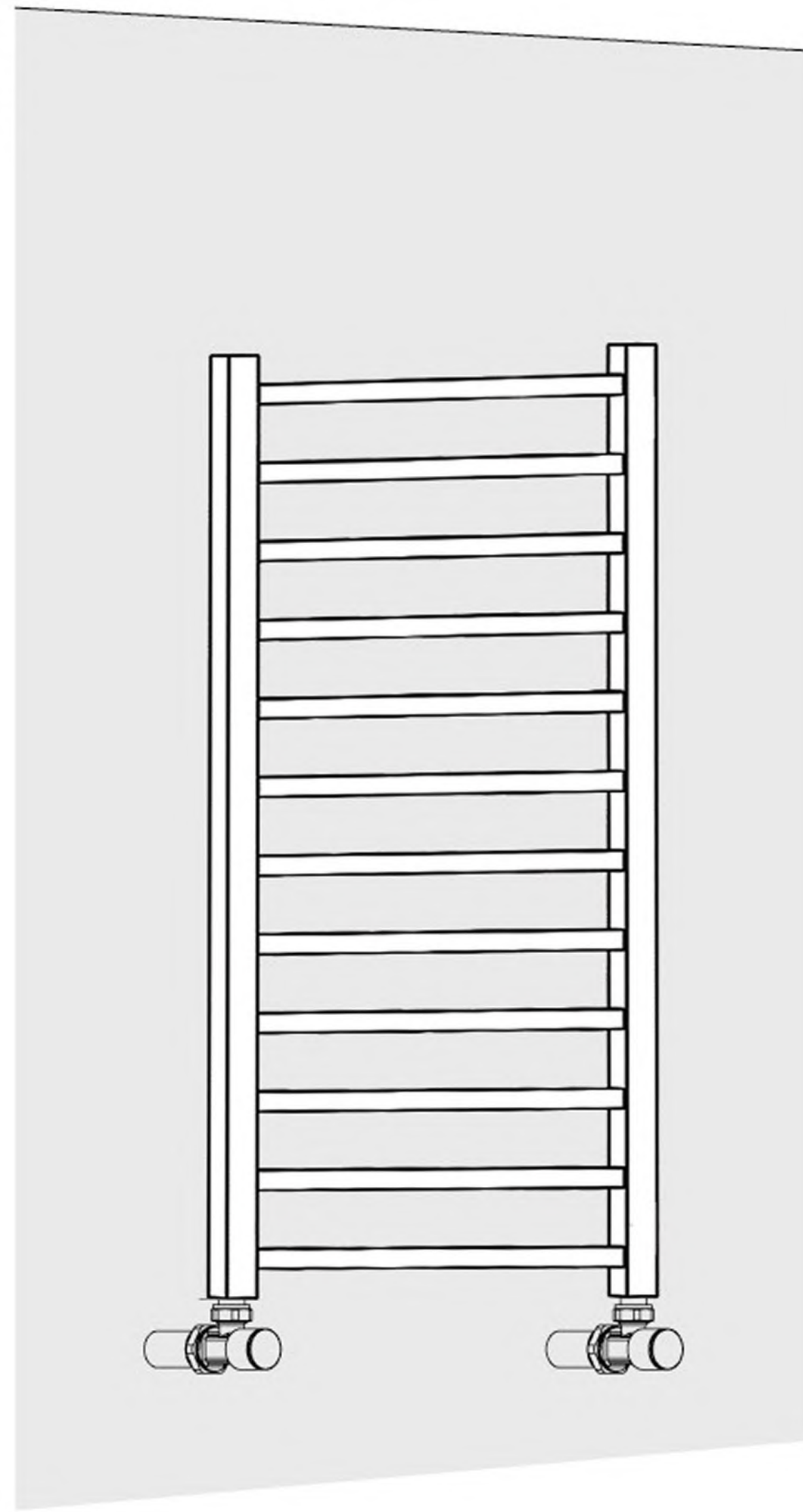

Option4 Dual fuel

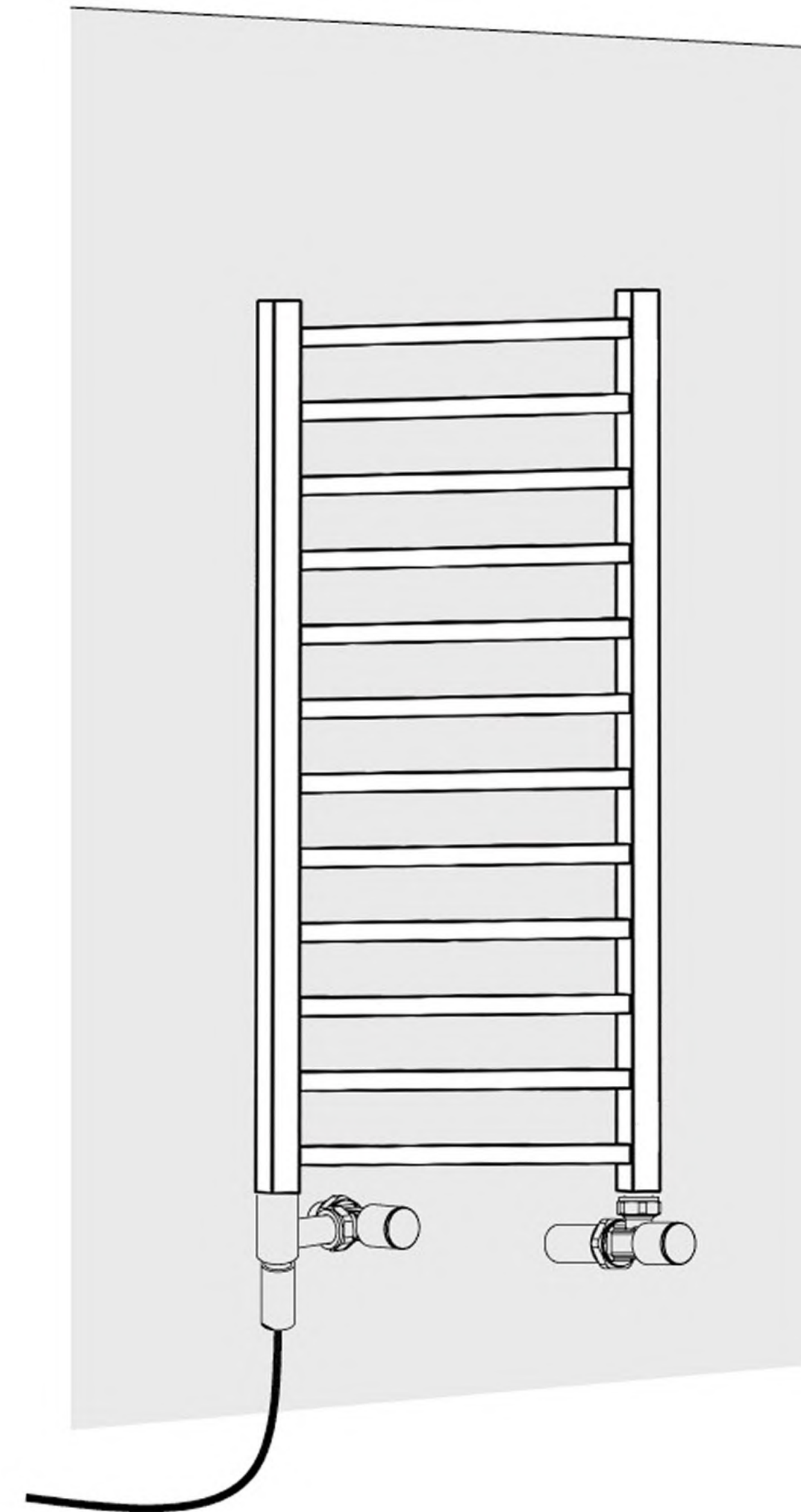

AFTER INSTALLATION (FOR OPTION 3&4 ONLY)

- Use a screwdriver to open the air vent, open the valve and let the water rush into the radiator .Check all connection for leaks.
- Once water overflows from the air vent, there is no air in the tube.
- Use a screwdriver to close the air vent, turn on the valve and the radiator is ready for use.

CARE & CLEANING

Radiators are made from steel with plating and should not be cleaned with corrosive or scouring cleaning agents.

TROUBLE SHOOTING

When your radiator doesn't function, knowing basic radiator troubleshooting can save you from the stress and the hassle of a non-functioning radiator. Here is a guide to solve the most common problems associated with these radiators.

| Problem | Cause | Action |
|---------------------------------------|---|--|
| Cold spots on the radiator unit | - Water is not flowing through radiator properly | - 1. Check to make sure there is no trapped air inside the radiator. "Bleed" the radiator to release trapped air. - 2. Make sure the valve is fully open to allow water to run freely. Some radiators may need diverter for water to flow properly around the unit. |
| Leak on the radiator | - Valve nut is loose - Welding problem | - Tighten the valve nut - Replace radiator |
| Sound of whistling or water whooshing | - Radiator was not properly balanced when it was installed | - Re-install |
| Clanking sound | - The radiator was installed in a space that doesn't allow for pipe expansion | - Re-install |