

# Installation Guide

# TOTO

## CW763Y





### Installation instruction

Please deliver the instruction to the end user.  
Please read this instruction carefully before installation.

#### I Installation Environment

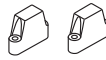
First, perform work according to the Installation Guide for the concealed cistern.  
Then follow the following steps to install the toilet. And the height of the water supply and drainage pipe according to the ceramic's dimension.

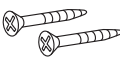
#### II Packing List

No.	Item	Quantity	Figure	No.	Item	Quantity	Figure		
1	Toilet	1		3	Fixation set	Floor fixation	2		
2	Decoration cap	2				Washer	4		
3	Fixation set	Fixation screw (Φ5.8x70)	2				Dowel	4	
							Screw (Φ6x50)	4	

#### III Installation dimensions

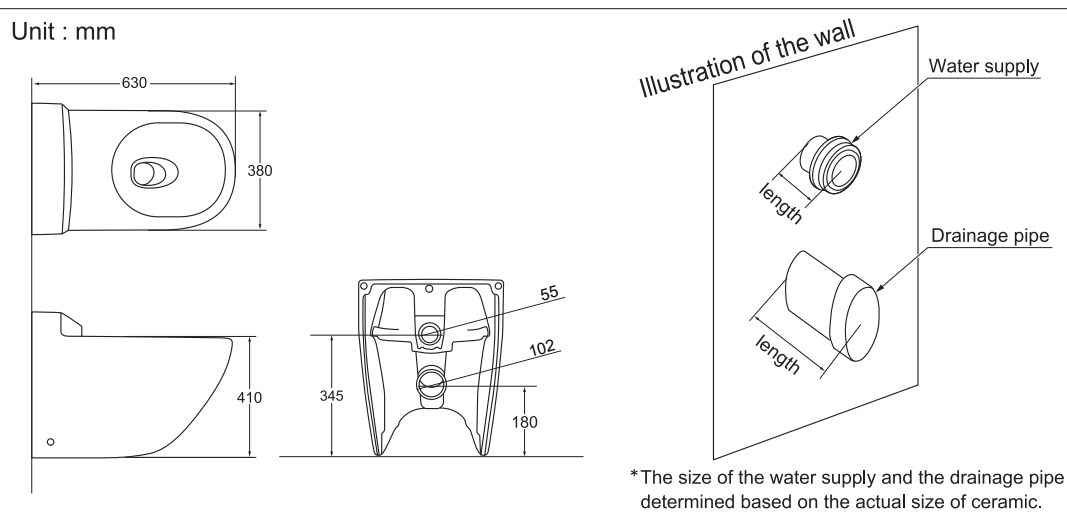

#### IV Installation the toilet

##### IV-1 Set the floor fixation position

Drill 4 holes according to the following figure, each with Φ8 mm.

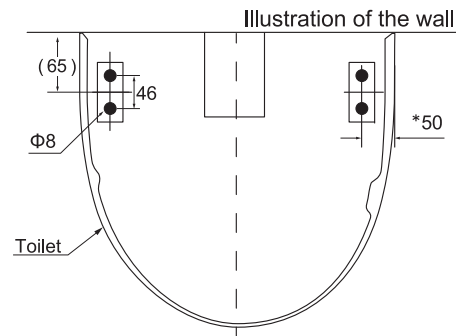

\*The position of the installation according to the outline of the toilet.

##### IV-2 Install the fixation set

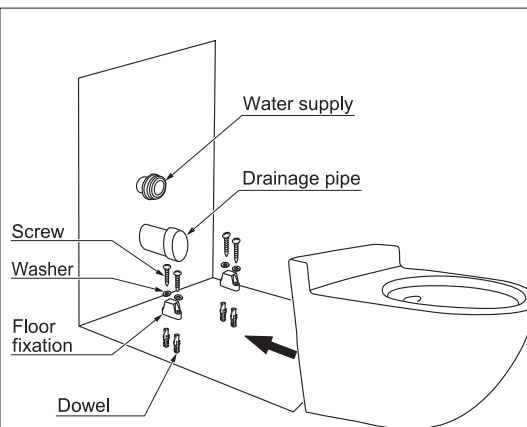

1. Fixate the floor fixation firmly as shown in the illustration using the dowels, washer and screws.
2. Push the ceramics towards the wall to connect it to the water supply and drainage.

##### IV-3 Installation the toilet

1. Screw the fixation screws through the mounting holes and fasten it.  
Make sure to fixate it firmly.
2. Then add the decoration cap.
3. The contact surface between the toilet base and ground surface should be sealed with silicone.

Note: Do not use epoxy resin

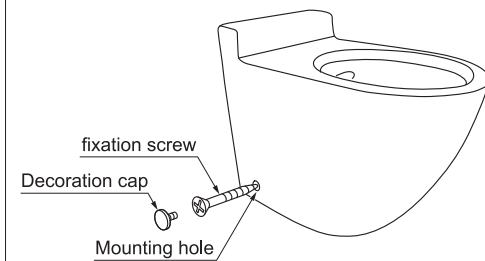

#### \* Important Toilet Using Information

1. If the water quality at your area is hard, clean the bowl regularly. Use a proper toilet cleaner and a toilet brush to prevent minerals from accumulation.  
The majority of toilet detergent will not damage the glaze of toilet.  
Please follow the instruction of the manufacturer of toilet detergent. Do not use corrosive agents or solvents.
2. Ceramic toilets are fragile, to prevent the damage and water leakage, please do not hit the ceramic hard.
3. To prevent cracking, do not use or install the toilet in the environment of below zero in temperature.

All the information in this instruction is based on the latest product information when printing this instruction. TOTO limited reserves the right to change of product features, packaging and supply any time without special notice.

# Installationsanleitung

# TOTO

## CW763Y





### Montageanleitung

Liefere Sie die Anleitung bitte dem Endbenutzer.  
Lesen Sie diese Anleitung vor der Montage aufmerksam durch.

#### I Montageumgebung

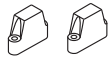
Befolgen Sie für die Montage zunächst die Installationsanleitung für den Unterputzpülkasten. Befolgen Sie dann die unten stehenden Schritte, um die Toilette zu montieren. Legen Sie die Höhe des Wasserzulaufs und des Ablaufrohrs entsprechend den Abmessungen der Toilette fest.

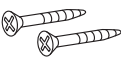
#### II Verpackungsliste

Nr.	Artikel	Menge	Abbildung	Nr.	Artikel	Menge	Abbildung
1	Toilette	1		3	Bodenhalterung	2	
2	Abdeckkappe	2			Unterlegscheibe	4	
3	Befestigungssatz Befestigungsschraube (Φ5,8x70)	2			Dübel	4	
					Schraube (Φ6x50)	4	

#### III Montageabmessungen

Einheit : mm



Abbildung der Wand



\*Die Größe des Wasserzulaufs und des Abflussrohrs basierend auf der tatsächlichen Größe der Toilette.

#### IV Montage der Toilette

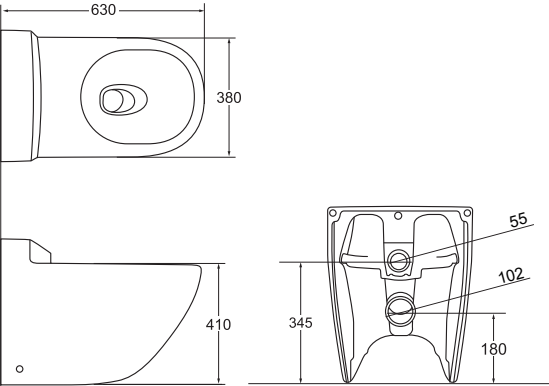
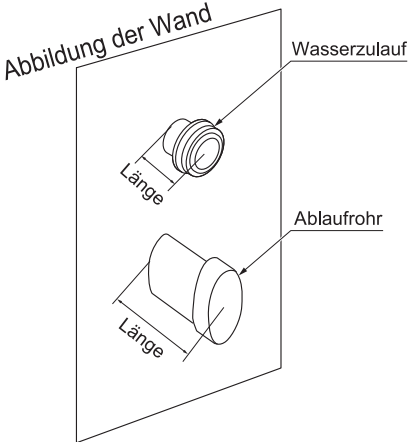
##### IV-1 Position der Bodenhalterung festlegen

Bohren Sie wie unten abgebildet vier Löcher mit jeweils 8 mm Durchmesser.

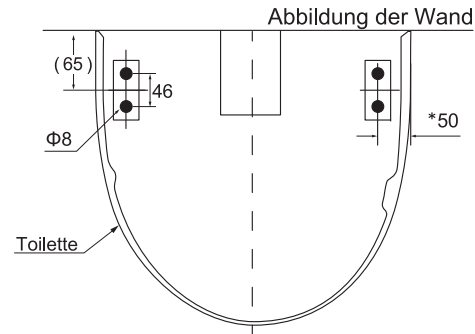

\*Die Montageposition anhand des Toilettenumrisses.

Einheit : mm

##### IV-2 Montage des Befestigungssatzes

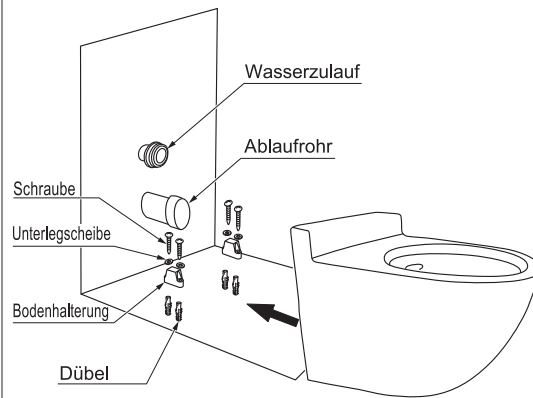

1. Bringen Sie die Bodenbefestigung unter Verwendung der Dübel, Unterlegscheiben und Schrauben wie in der Abbildung gezeigt fest an.
2. Setzen Sie die Toilette an die Wand, um sie mit dem Wasserzulauf und dem Ablaufrohr zu verbinden.

##### IV-3 Montage der Toilette

1. Führen Sie die Befestigungsschrauben durch die Montageöffnungen und ziehen Sie sie fest. Vergewissern Sie sich, dass sie richtig festgezogen sind.
2. Setzen Sie dann die Abdeckkappen darauf.
3. Dichten Sie die Kontaktfläche zwischen Toilette und Boden mit Silikon ab.

Hinweis: Verwenden Sie kein Epoxydharz.

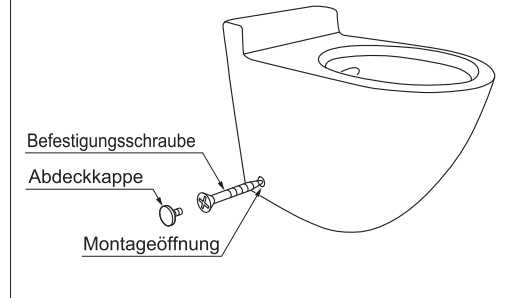

#### \* Wichtige Informationen zur Toilettennutzung

1. Wenn das Wasser in Ihrer Gegend hart ist, reinigen Sie die Schüssel regelmäßig. Verwenden Sie einen angemessenen Toilettenreiniger und eine Bürste, damit sich keine Mineralien ansammeln. Beschichtung der Toilette wird durch die meisten Toilettenreiniger nicht beschädigt. Befolgen Sie bitte die Anweisungen des Herstellers des betreffenden Toilettenreinigers. Verwenden Sie keine Scheuer- oder Lösungsmittel.
2. Keramiktoiletten sind zerbrechlich. Vermeiden Sie harte Stöße, um Schäden und Wasseraustritt vorzubeugen.
3. Um Rissen und Sprüngen vorzubeugen, verwenden oder montieren Sie die Toilette nicht in Umgebungen mit Temperaturen unter dem Gefrierpunkt.

Sämtliche in dieser Anleitung enthaltene Informationen basieren auf den zum Zeitpunkt des Drucks dieser Anleitung aktuellsten Produktinformationen. TOTO limited behält sich das Recht vor, Produktmerkmale, -verpackung und -angebot jederzeit ohne besondere Benachrichtigung zu ändern.

## Instructions de montage

# TOTO

## CW763Y

### Instructions d'installation

Veillez fournir les instructions à l'utilisateur final.  
Avant de procéder à l'installation, veuillez lire attentivement les présentes instructions.

#### I Environnement d'installation

Commencez par suivre les Instructions de montage pour installer la cuvette.  
Suivez ensuite la procédure décrite ci-après pour installer le WC. Ajustez la hauteur de l'alimentation en eau et du tuyau d'évacuation en fonction des dimensions de la cuvette.

#### II Contenu de l'emballage

N°	Élément	Quantité	Illustration	N°	Élément	Quantité	Illustration
1	Cuvette	1		3	Fixation au sol	2	
2	Capuchon décoratif	2			Rondelle	4	
3	Kit de fixation	2			Cheville	4	
					Vis (Φ6x50)	4	

#### III Dimensions d'installation

Unité : mm

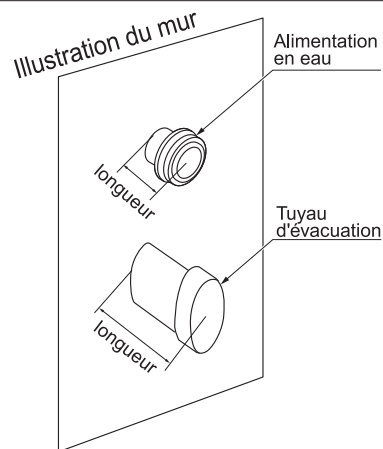
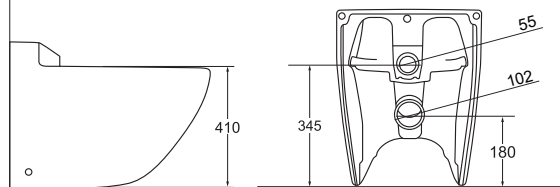
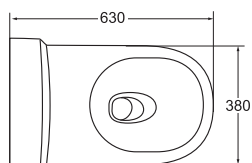

\*Taille de l'alimentation en eau et du tuyau d'évacuation déterminées sur la base de la taille réelle de la cuvette.

#### IV Installation de la cuvette

##### IV-1 Détermination de la position de fixation au sol

Percez 4 trous de 8 mm de diamètre chacun, comme indiqué sur la figure ci-dessous.

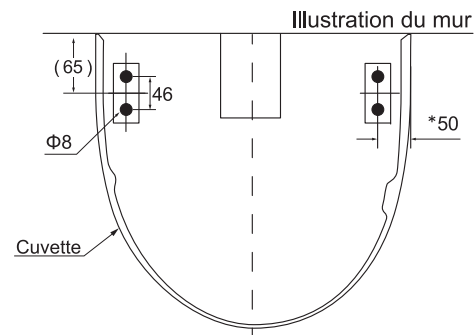

\*Position de l'installation en fonction du contour de la cuvette.

Unité : mm

##### IV-2 Installation du kit de fixation

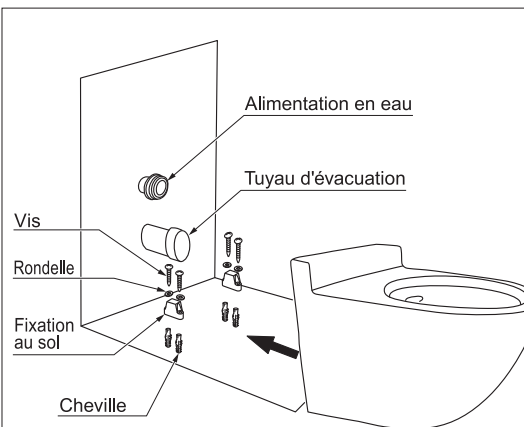

1. Attachez fermement la fixation au sol à l'aide des chevilles, des rondelles et des vis, comme indiqué sur l'illustration.
2. Poussez la cuvette en direction du mur pour la raccorder à l'alimentation en eau et au tuyau d'évacuation.

##### IV-3 Installation de la cuvette

1. Vissez les vis de fixation dans les trous de montage. Veillez à les attacher fermement.
2. Placez ensuite les capuchons décoratifs.
3. Un joint de silicone doit être appliqué au niveau de la surface de contact entre la base de la cuvette et le sol.

Remarque: n'utilisez pas de résine époxy.

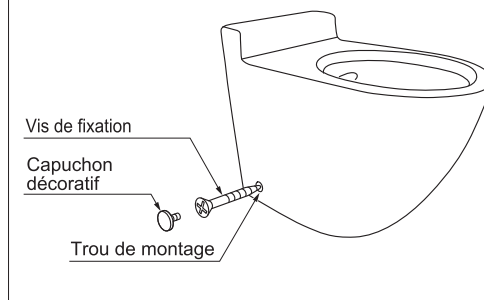

#### \* Informations importantes concernant l'utilisation du WC

1. Si l'eau dans votre région est dure, nettoyez la cuvette régulièrement. Utilisez un détergent pour WC adapté ainsi qu'une brosse pour éviter l'accumulation de minéraux. La plupart des détergents pour WC n'endommageront pas le vernis de la cuvette. Veillez suivre les instructions du fabricant du détergent. N'utilisez pas d'agents corrosifs ni de solvants.
2. Les WC en céramique sont fragiles. Pour éviter tout dommage et toute fuite d'eau, évitez les chocs importants.
3. Pour éviter toute fissure, n'utilisez ou n'installez pas le WC dans un environnement dont la température est inférieure à 0 degré.

Toutes les informations contenues dans ce manuel d'instructions sont basées sur les informations de produit les plus récentes au moment de l'impression dudit manuel. TOTO Ltd se réserve le droit de modifier à tout moment les caractéristiques, l'emballage et la fourniture du produit sans avis préalable.

# Guida per l'installazione

# TOTO

## CW763Y





### Istruzioni per l'installazione

Queste istruzioni devono essere consegnate all'utente finale.  
Leggere attentamente le istruzioni prima dell'installazione.

#### I Luogo di installazione

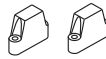
Eseguire prima i lavori secondo la Guida per l'installazione della cisterna nascosta.  
Quindi seguire i passaggi qui sotto per installare il WC. Rispettare l'altezza del tubo di mandata e di scarico dell'acqua in base alla dimensione del vaso.

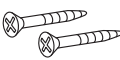
#### II Contenuto della confezione

N.	Articolo	Quantità	Figura	N.	Articolo	Quantità	Figura
1	WC	1		3	Elementi di fissaggio	2	
2	Tappi decorativi	2				4	
3	Elementi di fissaggio	2				4	
						4	

#### III Dimensioni di installazione

Unità di misura: mm

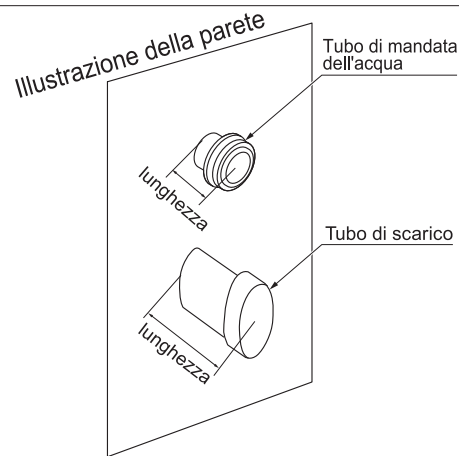
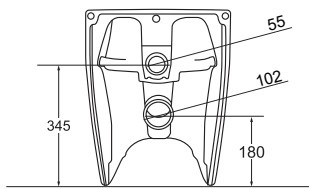
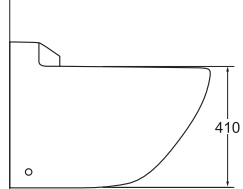
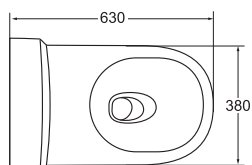

\*Le dimensioni del tubo di mandata e di scarico dell'acqua sono definite in base alle dimensioni effettive del vaso.

#### IV Installazione del WC

##### IV-1 Definire la posizione di fissaggio al pavimento

Eseguire 4 fori facendo riferimento alla figura seguente; ogni foro deve avere un  $\Phi$  di 8 mm.

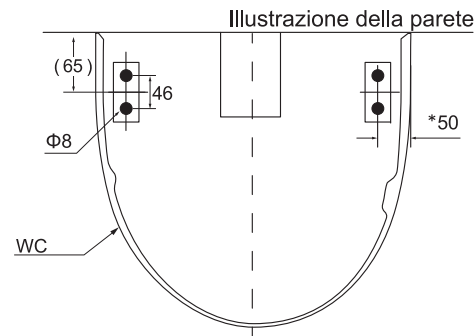

\*Posizione di installazione in base alla sagoma del WC.

Unità di misura: mm

##### IV-2 Installazione degli elementi di fissaggio

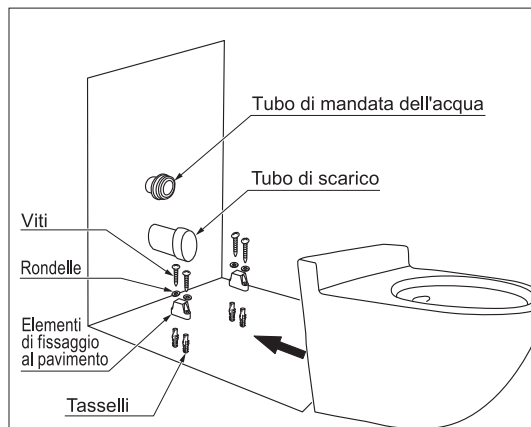

1. Fissare saldamente al pavimento come mostrato in figura usando i tasselli, le rondelle e le viti.
2. Appoggiare il vaso al muro per collegarlo al tubo di mandata e di scarico dell'acqua.

##### IV-3 Installazione del WC

1. Infilare le viti di fissaggio nei fori di montaggio e avvitare completamente.  
Accertarsi che il WC sia fissato saldamente.
2. Aggiungere quindi i tappi decorativi.
3. La superficie di contatto tra la base del WC e la superficie del pavimento deve essere sigillata con silicone.

Nota: non usare resina epossidica

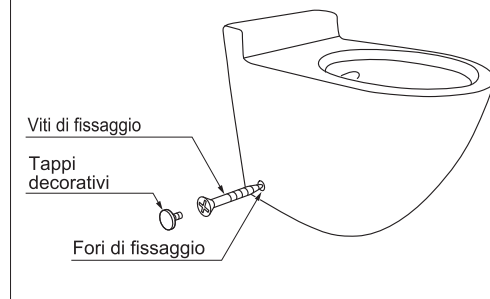

#### \* Informazioni importanti sull'utilizzo del WC

1. Se l'acqua nella zona di installazione è dura, pulire regolarmente il vaso. Usare un detergente e una spazzola idonei per evitare l'accumulo di depositi minerali. La maggior parte dei detersivi non rovinerà la superficie del WC. Seguire tuttavia le istruzioni fornite dal produttore del detergente utilizzato. Non usare agenti corrosivi o solventi.
2. I WC in ceramica sono fragili; evitare pertanto di colpirli con forza per non danneggiarli e per evitare perdite d'acqua.
3. Per evitare la formazione di crepe, non usare o installare il WC in ambienti che possono raggiungere temperature sotto lo zero.

Tutte le informazioni incluse in queste istruzioni sono da considerarsi valide al momento della stampa delle istruzioni stesse. TOTO Limited si riserva il diritto di modificare le specifiche del prodotto, la confezione e la fornitura in qualsiasi momento senza preavviso.