

HERITAGE

BATHROOMS

Installation Instructions & User Guide

Please leave these instructions with the end user

Product Code: SSABL01 (DI)

Specifications

Dynamic Water Pressure

Min: 0.2 bar Max: 5.0 bar

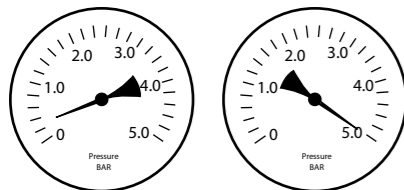

Maximum Static Pressure: 10.0 bar

Inlet Water Temperature

Cold Water Supply

Hot Water Supply

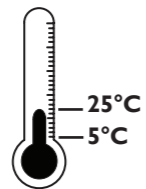

Min: 5°C Max: 25°C

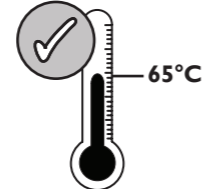

65°C Recommended

IMPORTANT The inlet hot water must be at least 10°C above the required blend temperature.

Inlet Dimensions

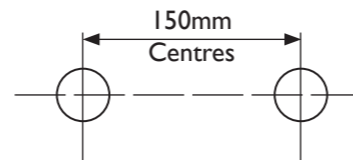

Inlet Connections



Tools You'll Need

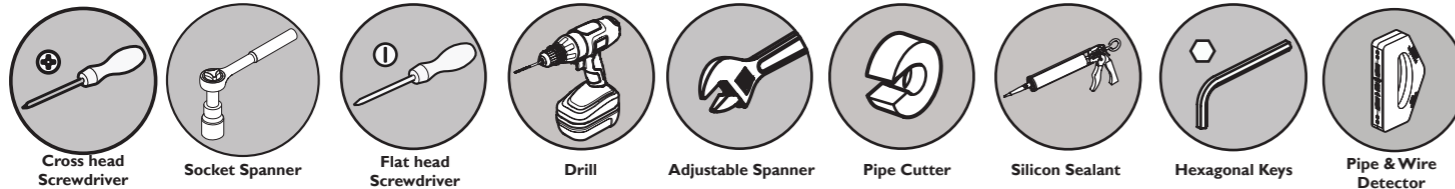

Prior to Installation

All products manufactured and supplied by Heritage are safe to use provided that they are installed, operated and receive regular maintenance in accordance with these instructions.

This product needs to be installed in accordance with, and meet the requirements of the Water Supply (Water Fittings) Regulations 1999 and current by-laws. For full Installation Requirements & Notes (IRN) please visit wras.co.uk/directory.

Isolation valves must be fitted to the inlet water supplies to ensure ease of future maintenance. Before installing this product the water supply must be thoroughly flushed in order to remove any swarf, solder etc. Full access must be made available for future maintenance/servicing purposes.

Before drilling into walls, check that there are no hidden electrical wires, cables or water supply pipes. This can be checked with the aid of an electronic detector.

If power tools are used do not forget to:
- Wear eye protection
- Unplug equipment after use

This product must not be modified in any way as this will invalidate the guarantee.

If in doubt, contact a registered plumber, your Local Water Authority or the Secretary of the Institute of Plumbing, address as follows:-

The Institute of Plumbing,
64 Station Lane,
Hornchurch,
Essex,
RM12 6NB, Tel: 01708 472791

Cavity Dimensions (mm)

Minimum Fitting Depth: 60mm

Maximum Fitting Depth: 75mm

Concealing Plate Adjustment Range: 15mm

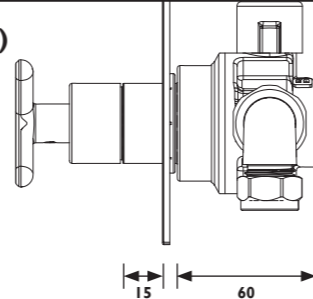

Pack Contents

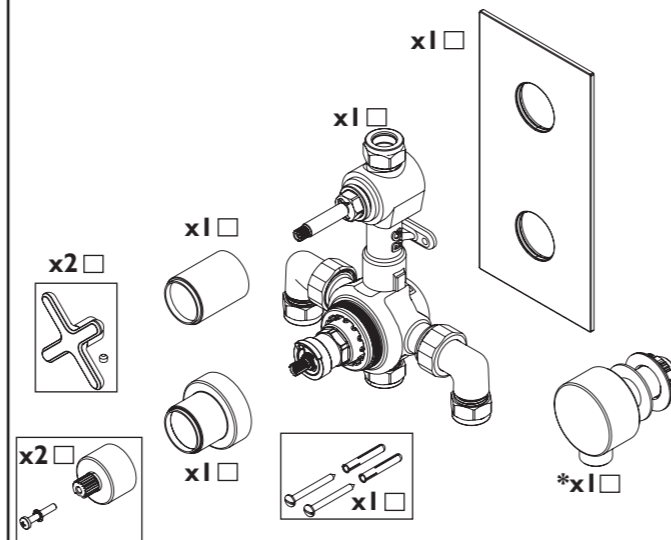

* not included with SSACDUAL codes

Valve Configuration

1

IMPORTANT
If installed in conjunction with a combination boiler flow regulators must be fitted.

Yellow Flow Limiter (Hot)

Green Flow Limiter (Cold)

Remove the inlet elbows and filters. Remove the plastic inserts from the valve inlets and insert the flow regulators. Replace the elbows, ensuring the filters are fitted.

2

Screw the shrouds onto the valve.

Installation

1

IMPORTANT
Rear access to the shower is required for maintenance and servicing

Prepare the pipework. Create the rear access point in the back of the wall cavity.

2



Cavity Space

Install suitable batons (if required) into the cavity. Take the finished wall surface into consideration when fitting the valve into the cavity. Mark the position of the valve; drill and plug holes to suit.

Baton

Rear Access Point

3

Secure the valve using the screws supplied (solid walls only) or a suitable alternative.

4

Hot

Connect the inlet pipes ensuring the olives are fitted.

Elbows can be pointed up or down

REMEMBER
hot on the left, cold on the right

5

Plumb your chosen outlet into the valve.

Turn on the water supply and check the valve for any leaks.

6

Draw around the concealing plate as a template, measuring in by 10mm to give clearance. Finish the wall surface. Using a silicon sealant, push on the concealing plate and hold firmly until set.

7

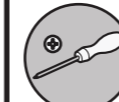

Fit the handles.

2

Increase Temperature

Pre-set to 42°C

Decrease Temperature

Turn the spindle to increase or decrease the temperature. Check the temperature and adjust until you achieve the desired result.

Temperature Adjustment

1

Turn the handle to the maximum temperature setting, then remove it. Remove the handle shroud.

3

Fit the temperature handle back in the maximum hot position.

REMEMBER
To service your product!

General Cleaning

Heritage products are made from premium materials, with hand polished, PVD, EPD or electroplated finishes.

Your product should be regularly cleaned with warm water, a mild pH-neutral liquid soap, and polished with a soft cloth. Any residues from soap, toiletries etc. should be rinsed off straight after use.

Household bleaches and cleaners contain harsh chemicals and may damage the surface finish. Avoid using abrasive cloths, scouring pads, scrub sponges, steel wool or anything similar.

Some surfaces such as nickel and pewter may be affected by the dye found in some cloths, so it is also important to avoid leaving cloths on surfaces.

Operation

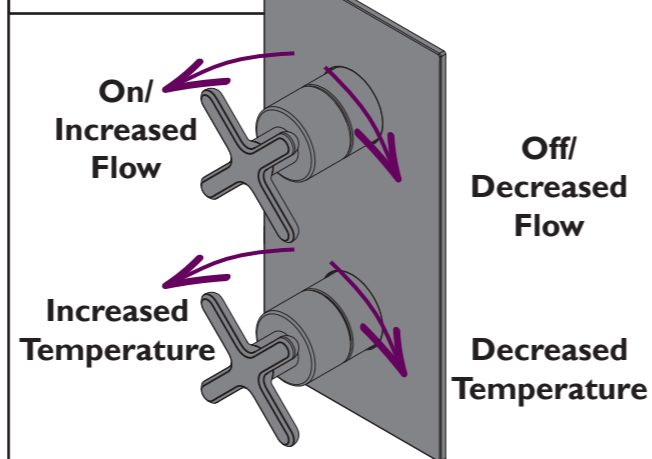

Wall Outlet Installation

Choose the location for the wall outlet and create a 25-30mm hole in the wall. Ensure your shower accessories have enough reach from that position. Finish the wall surface.

IMPORTANT
If you have purchased a **SSACDUAL** code, please follow the instructions supplied with your shower kit.

With rear access

Fit the wall outlet, ensuring the washers are fitted either side of the wall.

Go to Step 4 in the Installation Steps to connect the outlet pipework.

Without rear access

Follow Step 4 in the Installation Steps, fitting a 1/2" female connection at the hole in the wall (not supplied).

Screw the wall outlet into the 1/2" female connection, using a suitable thread sealant ensuring the rubber seal is fitted to the back of the wall outlet.

Servicing Intervals

To reduce the build up of lime scale and to ensure this shower works to its maximum performance we recommend this shower is serviced every 6-12 months depending on the hardness of your water.

Maintenance - Cartridge Cleaning

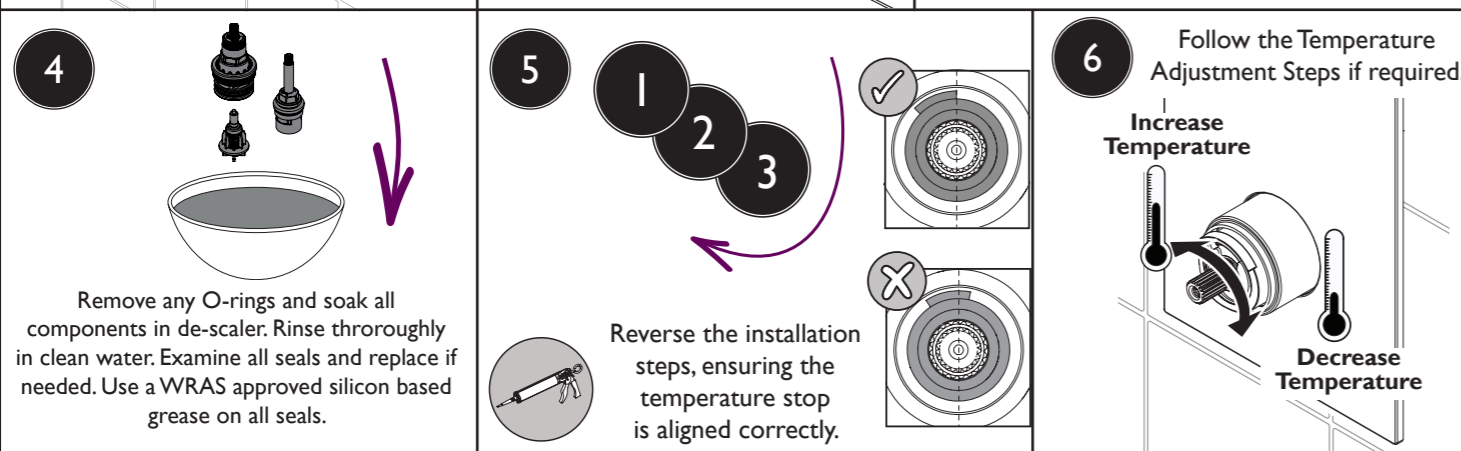
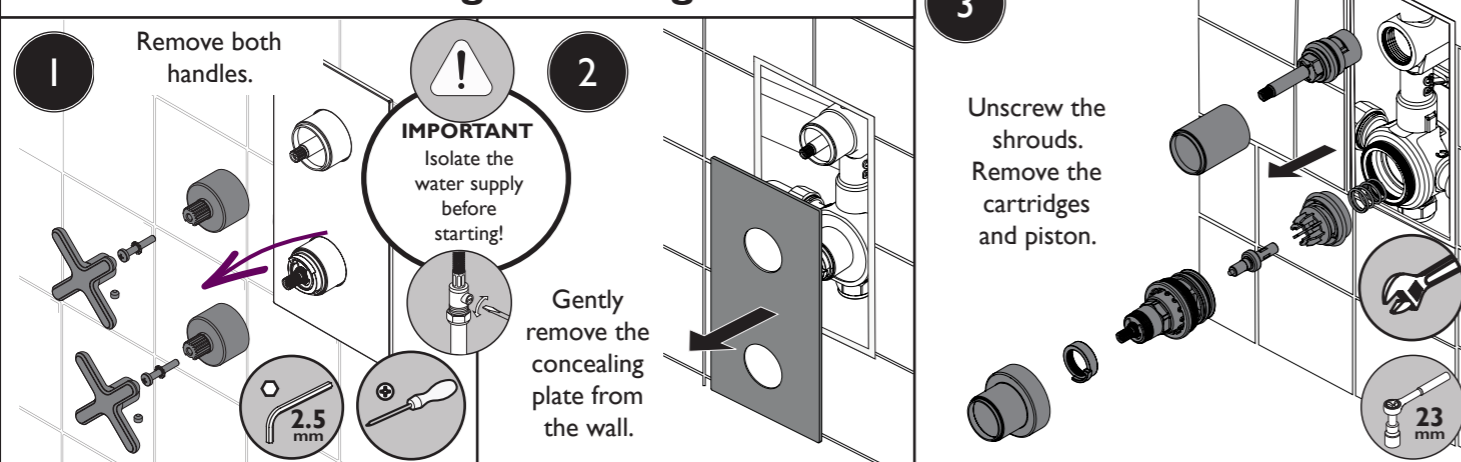

Troubleshooting

Symptom	Cause	Remedy
No flow or low flow rate	Partially closed isolation valve.	Open isolation valve.
	Instantaneous water heater cycles on and off as flow rate or pressure is too low.	Increase water flow rate or pressure through system.
	Head of water is below the minimum distance required.	Refer to the specification for the minimum distance required.
	Are the water supply pressures balanced?	If pressures are unbalanced, a pressure reducing valve should be used for optimum performance.
	Hot or cold water being drawn off elsewhere causing pressure changes or instantaneous boiler temperature changes.	Do not use other water outlets when using the shower.
	Airlock or partial blockage in the supply pipework.	Flush through pipework and filters to ensure removal of debris and any airlocks.
Maximum Water Temperature too Hot/Cold	Hot/Cold water supply has failed	Check the hot and cold feeds. The shower will not work if either fails.
	Maximum Water Temperature needs adjusting.	Refer to the Temperature Setting section to set your desired maximum temperature.
Outlet Water Temperature too Hot/Cold	Filter/pipe blockage	Flush through pipework and filters to ensure removal of debris and any airlocks.
	Installation conditions outside operating parameters.	Refer to the specification for the minimum distance required.
	Hot water temperature is less than 10°C above the required blend temperature	Adjust hot water temperature or wait for water to reheat if a stored water system is used.
	Instantaneous water not igniting because the water flow rate is too low.	Increase water flow rate through the system. Refer to the Maintenance section to clean/check the cartridge and filters for any damage. Contact your boiler manufacturer.
Only hot/cold water from Shower Valve	Instantaneous water not igniting because the water pressure is too low.	Refer to the specification for system requirements. Increase water pressure through the system. Contact your boiler manufacturer.
	Inlet water supplies are reversed.	Check the water inlet connections are the correct way around: Hot on the left, Cold on the right when viewed from the front. Rework pipework as necessary.
Water dripping from shower	Filter/pipe blockage	Flush through pipework and filters to ensure removal of debris and any airlocks.
	This is normal for a short time after using the shower.	This is caused by residual water tension, the build up of water in the shower.
Shower does not turn on	If water continues to drip, possibly due to the cartridge	Remove cartridge and clean, refer to the 'Maintenance' section before starting any maintenance.
	Closed isolation valve.	Open isolation valve.
	Mains water supply turned off.	Turn on mains water supply.

Our Guarantee

The confidence we have in the quality of our products and services enables us to offer a free peace-of-mind product guarantee from 2 years up to a lifetime guarantee against any manufacturing faults, with proof of purchase. In addition, our attentive customer service team are available to help solve any problems which may arise quickly and effectively so you can enjoy your bathroom.

To see the specific guarantee for this product, scan the QR Code or visit the following URL: <https://www.heritagebathrooms.com/service-centre/guarantee>



Bristan Group Ltd.

UK: Heritage Bathrooms, B78 ISG.
EU: Masco Europe S.à.r.l., 14 Rue Strachen
6933 Mensdorf, Luxembourg.

Customer Service: +44330 026 8503

Web: www.heritagebathrooms.com
Email: enquire@heritagebathrooms.com

A Masco Company

HERITAGE
BATHROOMS