

TOTO

Head Office

TOTO Europe GmbH
Zollhof 2, 40221 Düsseldorf Germany
Tel:+49 (0)700 8686 0700

TOTO

NEOREST

Instruction Manual with Warranty Information

> See Page 64.



NEOREST

TCF996RWG / RWSW
TCF994RWG / RWSW

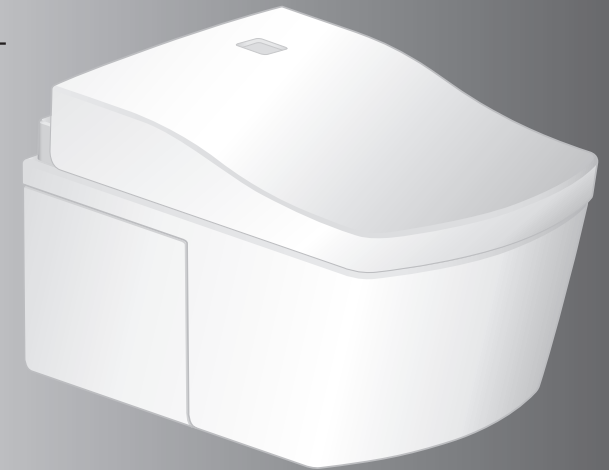

You are advised to record the following information to allow quick service.

Date of purchase :	Name of shop :
Date : year month day	
	Tel :

- Thank you for your recent purchase of the TOTO NEOREST. Please read the enclosed information to ensure the safe use of your product.
- Be sure to read this Instruction Manual before using your product and keep it in a safe place for future reference.

The available functions vary according to the model.

✓ Check your model name and write a check mark in this field as needed.

Model name
Part No.

Part number system
Top unit TCF○○○○
Bowl unit CW○○○○

Functions	Your Model	Model		Ref. Page		
		Part No.	NEOREST			
Basic Functions	Cleansing	Rear cleansing			16	
		Rear soft cleansing				
		Front cleansing				
	Changing the washing method	Wand position adjustment	●	●		
		Water pressure adjustment	●	●		
		Oscillating cleansing				
		Pulsating cleansing				
		Personal setting lock				
	Drying	Warm air drying	●	●		16
	Changing the temperature	Temperature adjustment	●	●		24, 25
Sanitary Functions	[ewater+] sanitizing	Auto wand cleaning	●	●	20, 21	
		Auto bowl cleaning	●	●		
	Maintaining the bowl unit cleanliness	Photocatalyst cleaning	●	-		
	Removing odors	Deodorizer	●	●		
Convenient Functions	Flushing	Remote control bowl unit cleaning	●	●	17	
		Auto bowl unit cleaning	●	●		
	Opening and closing	Opening and closing the toilet seat with remote control			22, 23	
		Auto open / close (lid)	●	●	22, 23	
	Lighting up	Soft light				
	Heating the toilet seat	Heated seat	●	●	-	
	Saving energy	Timer energy saver	●	●	26, 27	
Auto energy saver		●	●			
Maintenance	Wand cleaning	●	●	33		
	Descaling mode	●	●	34		

Cleaning Support Sanitary Toilet

The [ewater+] feature and "photocatalyst cleaning*" keep the toilet bowl clean at all times.

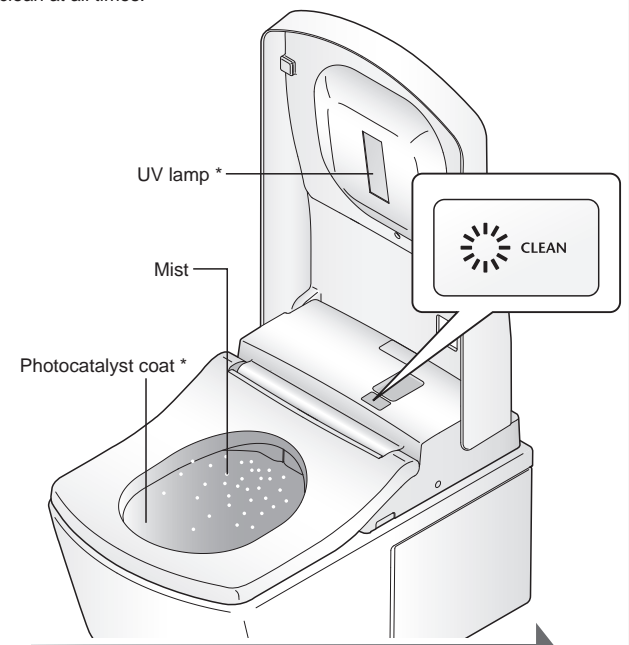

The self-cleaning functions operate automatically. (See pages 20 and 21 for details.)

- | As you approach and sit | As you stand up | As you move away |
|---|---|--|
| <ul style="list-style-type: none"> A mist is sprayed in the bowl unit to make it more difficult for dirt to adhere. When you sit on the toilet seat, the deodorizer operates. | <ul style="list-style-type: none"> The wand is cleaned with [ewater+]. (The wand extends and then retracts.) | <ul style="list-style-type: none"> [ewater+] is sprayed in the bowl unit to maintain cleanliness. The UV lamp lights up for about 1 hour.* |



Table of Contents

	Introduction
Safety Precautions	4
Operational Precautions	11
Parts Names	12
Preparation	14
<hr/>	
Basic Operations	16
Automatic Functions (Cleaning Features)	20
DEODORIZER, AUTO WAND CLEANING, AUTO BOWL CLEANING, BOWL LIGHT, PHOTOCATALYST CLEANING, CLEAN INDICATOR	
Automatic Functions (Convenience Features)	22
AUTO FLUSH, AUTO OPEN/CLOSE, SOFT LIGHT	
Temperature Adjustment	24
Energy Saver Features	26
<hr/>	
Power Plug / Top Unit	30
Bowl Unit	32
Wand	33
Wand cleaning	
Deodorizing Filter	33
Descaling mode	34
Water Filter Drain Valve	39
<hr/>	
Changing Settings	40
What to Do?	52
● If there is no water due to a power outage or water failure	52
● If you cannot operate with the remote control	52
● Freeze Damage Prevention	53
● Long Periods of Disuse	54
Troubleshooting	55
Specifications	63
Warranty	64
Important User Guidance Information	65



Safety Precautions

These precautions are important for safe usage. Be sure to follow them and use the product correctly.

Symbols and Meanings

	WARNING	May result in death or serious injury.
	CAUTION	May result in injury or property damage.

The following symbols are used to indicate important safety instructions for the use of the product.

Symbol	Meaning
	This symbol indicates a prohibited use of the product.
	This symbol is used to indicate a required step in the use of this product.

- This product is classified as Class 1 Equipment and must be grounded via an ground connection.
- Install this equipment close to a electrical outlet.
- This equipment is not to be used by any person who has reduced physical, sensory or mental abilities (including children), nor is it to be used by any person who lacks sufficient experience or knowledge. However, such persons may use the equipment when a person who takes responsibility for their safety provides supervision and direction.
Children must be supervised to make certain that they do not play with the equipment.
- Use the new hose set included with this equipment. Do not reuse an old hose set.

WARNING

- | | |
|---|--|
|  | Do not touch the power plug or connection of electrical box with wet hands. |
| | • Doing so may cause electrical shock. |
| | Do not get any water or cleaning solution on the top unit or power plug or electrical box. |
| | • Doing so may cause fire, electrical shock, heat or short circuit. |
| | • Doing so may cause the product to crack resulting in injury or water damage. |
| | Never disassemble, repair or alter. |
| | Do not use tools in places other than designated. |
| | • Doing so may cause fire, electrical shock, overheating, short circuit or breakdown. |
| | Do not install the product on moving vehicles such as wheeled vehicles or boats. |
| | • Doing so may cause fire, electric shock, short circuit or malfunction. |
| | • The toilet seat, toilet lid, top unit or other parts may come loose and fall off, resulting in injury. |

WARNING

Do not use the NEOREST if a malfunction occurs.

- In case of breakdown or other problem, be sure to cut off power by means such as unplugging the power plug or switching the breaker in the distribution board to OFF.
- Close the water shutoff valve to stop water supply.

Possible malfunctions:

- Water is leaking from a pipe or the top unit.
- The product is cracked or broken.
- The product makes a strange noise or emits a strange odor.
- The product emits smoke.
- The product is abnormally hot.
- The bowl unit is clogged.
- The toilet seat cushion is out of place.

- Continued use after malfunction could cause a fire, electric shock, heat, short circuit, injury or water damage.

Only use tap water or potable well water (underground water).

Do not use seawater.

- Doing so may cause irritation to the skin and malfunction.

Do not touch the power plug or electrical box during thunderstorms.

- Doing so may cause electrical shock.



Do not allow the water supply hose to touch the power plug or outlet or electrical box.

- Doing so may cause condensation resulting in a fire, electrical shock, heat or a short.

Do not do anything that may damage the power cord, power plug.

Do not strike, yank, twist, excessively bend, damage, alter, or heat the electrical cords. Also, do not place anything heavy on, bind or pinch the electrical cords.

- Using a damaged electrical cord may result in a fire, electrical shock, heat or short.

Do not use a loose or faulty electrical outlet. (Europe and Russia)

- Doing so may cause fire or short circuit.

Do not use any outlet or wiring equipment beyond its specified rating.

(Europe and Russia)

- Plugging too many plugs into the same outlet, for example using outlet splitters, can cause fire due to heat.

Do not use any power supply other than the one specified.

AC 220V - 240V, 50Hz

- Doing so may cause fire or excessive heat.

Safety Precautions (Continued)

WARNING

To reduce the danger of burns, death from electric shock, fire or other human injury:

- Never operate this product if it has a damaged cord or plug, if it is not working properly, if it has been dropped or damaged, or if it has been dropped in water. Return the product to TOTO Europe GmbH for examination and repair.
- Never block the air openings of the product or place it on a soft surface, such as a bed or a couch, where the air openings could be blocked. Keep the air openings free of lint, hair or a similar material.
- Never use it while sleepy or drowsy.
- Never drop or insert anything into any opening or hose.
- Do not use it outdoors where aerosol (spray) products are being used or where oxygen is being administered.

Do not stick a finger or anything else into the warm air outlet.

Do not place anything on the warm air outlet or drape clothes over it.

- Doing so may cause burns, electrical shock or malfunction.

Keep cigarettes and other open flames away from the product.

- Failure to do so may cause fire.



WARNING

Refrain from sitting on the seat for long periods.

- Improper use of the toilet seat may cause irritation or burn.
When sitting for a long time on the toilet seat, switch the toilet seat temperature adjustment to "OFF". When any of the following persons use a heated seat or warm air drying, someone should switch the toilet seat temperature adjustment to "OFF" and switch the drying air temperature to "Low".
 - Young children, the aged and other users unable to set the temperature appropriately themselves
 - The ill, physically disabled and others who do not have freedom of movement.
 - Those using any medicines that cause drowsiness (sleeping or cold medicine), those who have been drinking heavily, anyone severely fatigued and anyone else liable to fall asleep.

To reduce the danger of burns, death from electric shock, fire or other human injury:

- Close supervision is necessary when this product is used by or near children or invalids.
- Use this product only for its intended use as described in this manual. Do not use accessories not recommended by the manufacturer.
- Keep the cord away from heated surfaces.
- Connect this product to a properly grounded outlet only.

This is an electrical product. Do not install it anywhere water is likely to get on the product or anywhere with humidity high enough that water is likely to form on the surface of this product. When using the product in a bathroom, install a fan or ventilation port and ensure good air flow through the bathroom.

- Failure to do so may cause fire or electrical shock.

Always connect the NEOREST to the cold water supply.

- Connecting to hot water supply may result in burns and equipment damage.

Check that an appropriate ground is installed.

- If the ground is not installed, if there is a breakdown or electrical current leak, the lack of a ground could cause electrical shock. For the ground, use copper wire with a ground resistance of 100 Ω max. and a diameter of 1.6 mm min.

* If there is no ground installed, ask the contractor who did the installation to install the ground.

Make sure that a properly grounded (3 prong) outlet has been installed.

- Failure to install a grounded outlet could cause electrical shock in the event of a malfunction or short circuit.

Check that the outlet for electrical power is as follows.

- Failure to do so may cause fire or electrical shock.
 - a. Apply a current to the outlet (or device) through a differential residual current device (DDR) whose release current does not exceed 30 mA.
 - b. Install the outlet (or device) and its wiring plug at least 0.60 m away from the outside of the shower tub or bathtub.

* Check that the wiring in a. and b. above is complete. If the wiring has not been completed, ask the contractor who did the installation to do it.



Safety Precautions (Continued)

WARNING

Insert the power plug securely into the outlet.

Check that the power cord is connected. (UK)

- Failure to do so may cause fire, heat or short circuit.
- * When installing this product, observe the local laws and regulations regarding installation.

To unplug, hold the plug, not the cord. (Europe and Russia)

Do not unplug by pulling the cord.

- Pulling on the cord may cause damage and result in fire or heat.

If the electric cord is damaged, avoid danger by having the manufacturer's repair department or equivalent specialist replace it.

Always disconnect the power plug from the outlet before cleaning, maintenance or inspection.

Always switch the breaker on the distribution board to OFF. (UK)

- Failure to do so may cause electrical shock or malfunction.
- * Except when using "Wand cleaning"

Periodically remove dust and dirt from the power plug and make sure it is securely plugged into the wall outlet. (Europe and Russia)

- Failure to do so may cause fire, heat or short circuit.
- Pull the plug out from the outlet and wipe clean with a dry cloth.

Always unplug the plug from the outlet before removing the top unit.

Always switch the breaker on the distribution board to OFF. (UK)

- Failure to do so may cause fire or electrical shock.

When leaking battery fluid adheres to your body or clothes, wash it away with clean water.

- The fluid may damage your eyes or skin.

CAUTION

Do not use the product if the top unit is unstable.

- Doing so may cause the top unit to come loose and fall, resulting in injury.

If the product is damaged, do not touch the damaged section.

- Doing so may cause electrical shock or injury.

Replace it immediately. **Do not apply strong force, mechanical shock, step on or stand on the toilet seat, toilet lid or top unit. Also do not place any heavy object on the toilet seat, toilet lid or top unit.**

- Doing so may cause cracking or cause the top unit to come loose and fall, resulting in injury.
- Doing so may damage the product and cause injury or water damage.

Do not lift up this product by the toilet seat or lid. Do not raise the toilet seat or lid while objects are resting on top of the toilet.

- Doing so may cause the top unit to come loose and fall, resulting in injury.

To reduce the danger of death from electric shock:

- Do not use while bathing.
- Do not place or store the product where it could fall or be pulled into a tub or sink.
- Do not put in or drop into water or other liquid.
- Do not try to recover the product if it has fallen into water. Unplug it immediately.
- Always switch the breaker on the distribution board to OFF. (UK)

When cleaning or maintaining the plastic parts (top unit etc.) or the water supply hose, use a kitchen cleaner diluted with water. Do not use any of the following.

Toilet cleaner, household cleaner, benzene, paint thinner, powdered cleanser or nylon scrubbing pads.

- These items may damage or crack the plastic and cause injury or malfunction.
- These items could damage the water supply hose and cause a water leak.

To prevent a sudden water leak, do not remove the water filter drain valve when the shutoff valve is open.

- Doing so will cause water to spurt out.
- (Refer to Page 39 for instructions on cleaning the water filter drain valve.)

Do not fold or crush the water supply hose; do not damage by cutting with a sharp object.

- Doing so may cause water leaks.

Do not pour hot water into the toilet.

- Doing so may result in damage to the toilet, injury or water damage.

Do not flush anything other than bodily waste and toilet paper. Also, do not flush too much toilet paper.

- Doing so may clog the toilet, causing waste water overflow and water damage.

Keep the bowl filled with water.

- Failure to do so may cause sewer gas, chlorine gas, or hydrogen sulfide to corrode facilities and equipment.

Do not look directly at UV light.

- May cause eye or skin irritation.
- There are no user replaceable parts. Shall be serviced by qualified personnel only.

Safety Precautions (Continued)

⚠ CAUTION

If a water leak should occur, always close the shutoff valve.

When the ambient temperature is likely to drop to 0°C or lower, prevent damage to the pipes and hoses due to freezing.

- Frozen water pipes could cause the top unit and the pipes to break, resulting in a water leak.
- Regulate the room temperature to prevent the pipes and hoses from freezing during cold months.

When not using the NEOREST over an extended period of time, drain the water out of the top unit and the water supply hose, and pull the electrical plug from the outlet.

Switch the breaker on the distribution board to OFF. (UK)

- When using the product again, allow the product to refill with water first. Otherwise, the water in the tank might become contaminated and cause skin inflammation or other problems. (Refer to Page 54 for instructions on replenishing the water.)
- Leaving the power on may cause fire or heat.

When installing the water filter drain valve, make sure that it is securely tightened in its proper position.

- Failure to securely tighten it may cause a water leaks.

If the bowl unit is clogged, disconnect the power plug and remove the clog.

Switch the breaker on the distribution board to OFF and remove the clog. (UK)

- If the auto flush were allowed to function, it would make the wastewater in the bowl unit overflow and may result in water damage.
- Use any commonly available toilet plunger to remove the clogging.

Always flush, even after just urinating.

- Failure to do so may clog the toilet, causing waste water overflow and water damage or inadequate flushing of the bowl unit.

Wipe condensation on the bowl unit, tank, water supply pipe and shutoff valve with a dry cloth.

- Condensation may cause staining and corrosion of the floor.
- Ventilate the restroom to prevent condensation.

Wipe any urine, condensation, cleaner, water, etc. that has gotten on the floor with a well-wrung mop or cloth.

- Failure to do so may cause staining and corrosion of the floor.

Make sure of the plus and minus signs on the batteries before inserting them.

Remove depleted batteries immediately.

When replacing the batteries:

Replace both batteries with new ones.

Use the same brand for both new batteries (any brand available).

- Failure to do so may cause the batteries to leak fluid, generate heat, rupture, or ignite.

When the product is supposed not to be used for long time, remove the batteries from the remote control and battery box.

- Failure to do so may cause the batteries to leak fluid.

Operational Precautions

■ For prevention of malfunctions

- Do not block the body sensor or the remote control transmitter or receiver.

< About the body sensors >

- Body sensors detect a person standing in front of the bowl unit.
 - Body sensors emit an infrared beam as shown in the figures. When someone moves into the line of this infrared beam, the sensor detects the person.
 - * Detection by the sensor may be difficult when the toilet is used by someone small, such as a child.

Body sensor A



Body sensor B



< About the seat switch >

- When you sit on the toilet seat, the seat switch turns ON, enabling you to use various features. (A click sound is heard when the seat switch is ACTIVATED.)

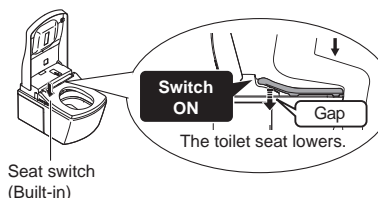

Seat switch (Built-in)

- Sit back on the toilet seat.
 - The seat switch will not turn on unless you sit on the seat properly.



Note

- When a child uses the NEOREST, the seat switch may not be ACTIVATED by their light body weight.
- Since the toilet seat is designed to move up and down, a clearance is provided between the toilet seat cushion and the toilet bowl.

■ For prevention of damage

- Wipe plastic areas such as the top unit and remote control with a soft, wet cloth.
- Do not lean against the toilet lid.



■ Problem Prevention

- Disconnect the power plug if there is a risk of lightning. Switch the breaker on the distribution board to OFF. (UK)
- A toilet seat cover or a toilet lid cover cannot be used. (The body sensors or seat switch may not function properly.)



- Do not urinate on the top unit, toilet seat or wand. (Doing so may cause pink or brown stains or a malfunction.)
- Do not apply strong forces to the control panel of the remote control.
- When using a toilet cleaner to clean the toilet, wash it off within 3 minutes and leave the toilet seat and toilet lid open. Wipe off any cleaner that remains on the toilet bowl. (If vapor from a toilet bowl cleaner enters the top unit, it may cause a malfunction.)
- Do not expose to direct sunlight. (Doing so may cause changes in color, irregular heated seat temperature, remote control malfunction or NEOREST malfunction due to the change in temperature.)
- Use radios, etc. away from the NEOREST. (The NEOREST could cause interference with the radio signal.)
- If you use a booster seat for infants or a soft highchair, remove it after use. (Keeping it installed may prevent some of the functions from being used.)
- Do not apply force to the remote control. (May cause malfunction.) To prevent the remote control from being dropped, set it in the hanger when you are not using it. Be careful not to expose it to water.

About rear cleansing, rear soft cleansing and front cleansing

- These functions wash away waste and dirt from a localized area of your body.
- Do not cleanse too much or for too long. Doing so may wash away normal bacteria, upsetting the balance of bacteria inside your body.
- People who are receiving medical treatment or therapy in this localized area should consult their doctor before use.

Parts Names

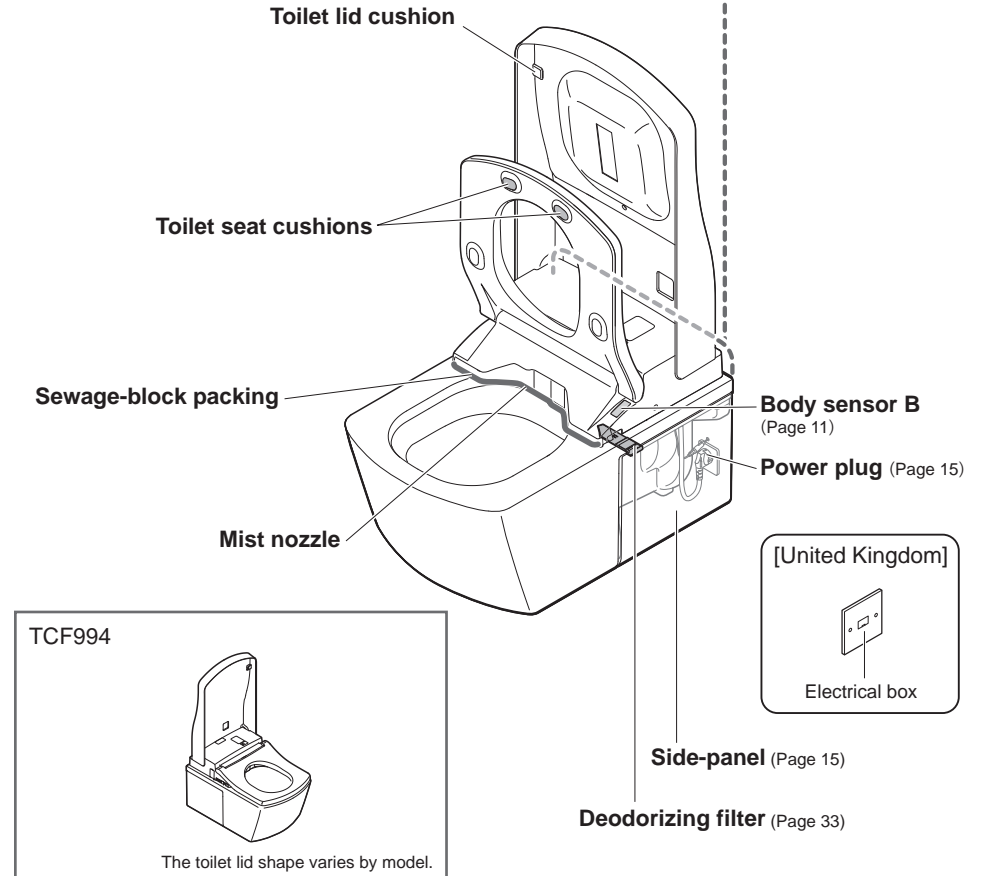
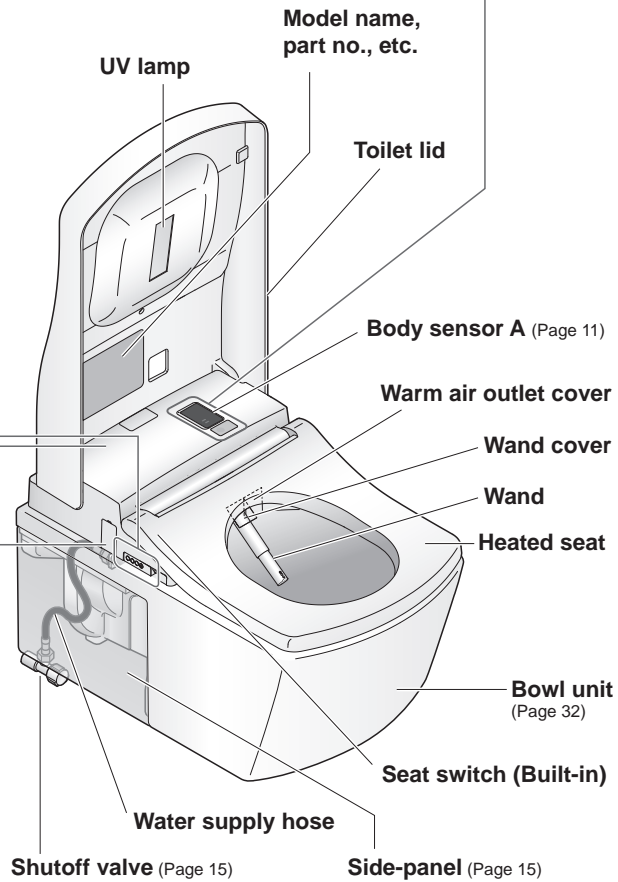
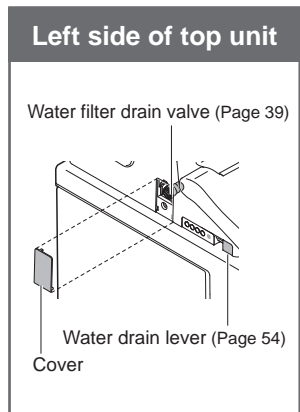
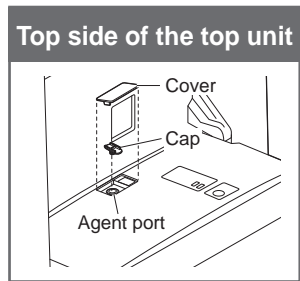
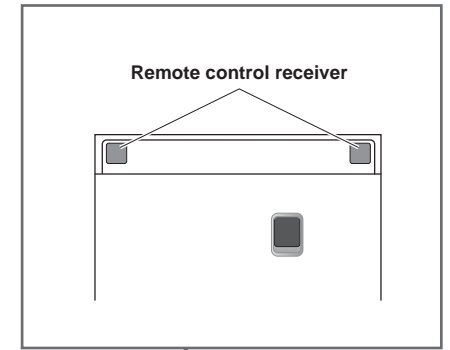
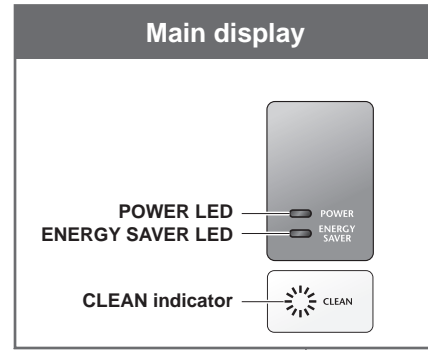
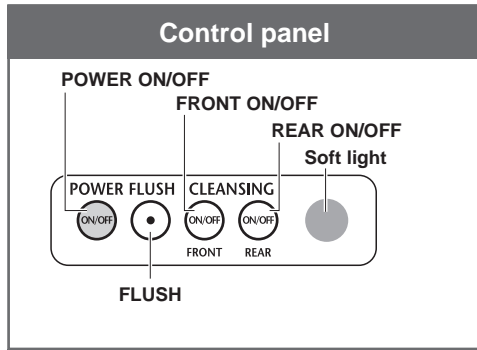

Preparation Using the Product for the First Time



1. Insert the battery

1 Remove the remote control from the hanger.

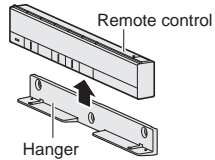

2 Open the battery cover and insert two AA batteries.

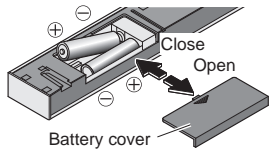

- When batteries are properly inserted, temperature levels appear on the display of the remote control (back side).
- The display goes out when no button on the remote control is pressed for 1 minute or more.

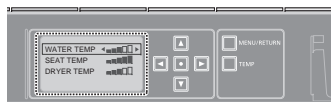

3 Mount the remote control in the hanger.

- About the batteries
- Use dry cell, alkaline batteries.
 - Be sure to follow "Safety Precautions" to prevent the batteries from rupturing or leaking fluid. (Pages 8, 10)

If the remote control is secured (for anti theft)

1 Remove the screws (2, left and right) from the remote control fixture.

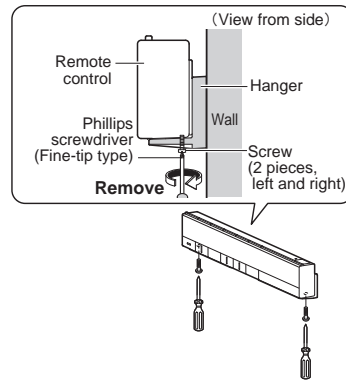

2 Remove the remote control from the hanger.

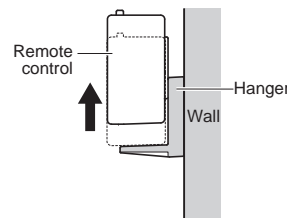

- To secure the remote control again
- Tighten and fix the screws (2, left and right). (Overtightening may cause damage to parts such as the hanger)

2. Turn on the power

1 Remove the side-panel and insert the power plug.

Switch the breaker on the distribution board to ON. (UK)

- The wand extends and then retracts.
- Flushes automatically.

Loosen the bottom screw of the side-panel (right) with a flat-head screwdriver, pull the side-panel diagonally upward, and then pull it out downward.

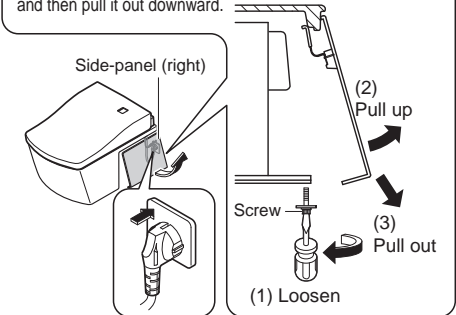

- Both side-panels can be removed or installed in the same way.
- Dropping the side-panels may cause damage.

2 Check that the POWER LED on the main display is lit up.

- If it does not light up, press [POWER ON/OFF] to light it up.

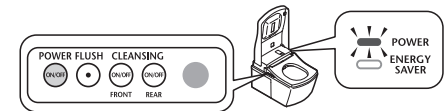

3 Reinstall the side-panel. (Europe and Russia)

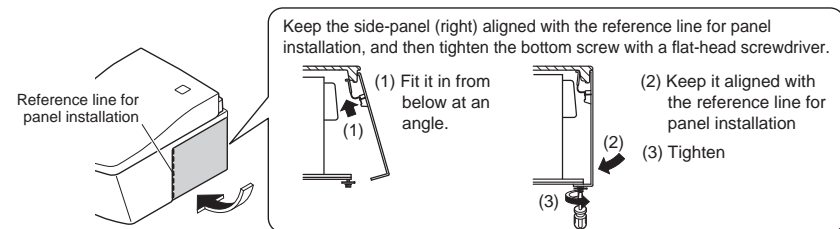

To turn the power "OFF"

POWER
ON/OFF
Press [POWER ON/OFF] to turn the power off.

- The POWER LED goes off.

3. Open the shutoff valve

1 Fully open the shutoff valve. The shutoff valve is located in the side-panel (left). (Refer to the above for removal and installation.)

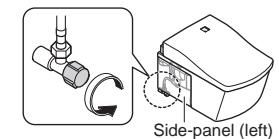

Basic Operations

Press a button on the remote control; a beep sounds when the top unit receives the signal.

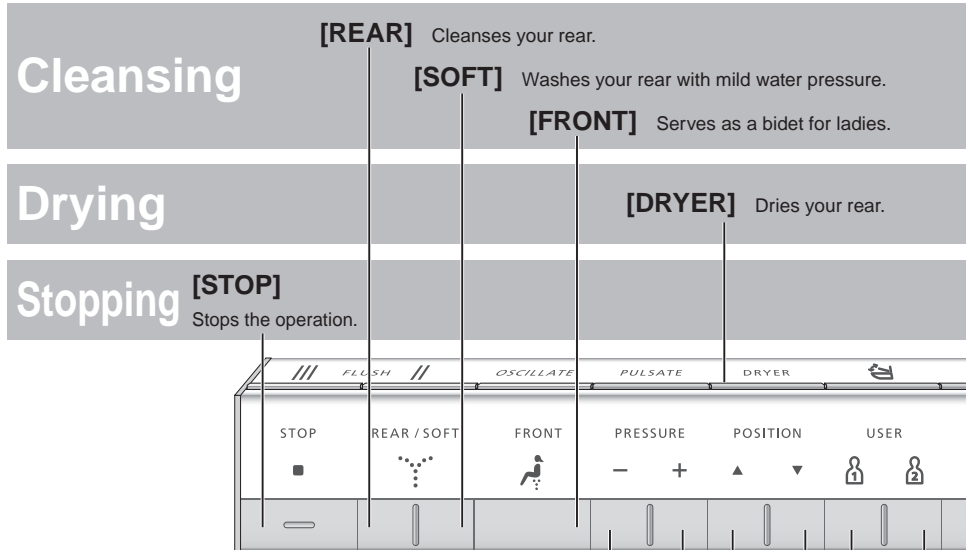

- [PRESSURE]**
- You can adjust the water pressure to one of five levels. ([-]: Softer, [+]: Stronger)
 - When you press the button to flush, the position returns to the standard position (3rd position).
 - If you do not want to return the wand to the standard position. (Page 50)
- [OSCILLATE]**
- The wand moves back and forth to wash your rear thoroughly.
 - The setting changes between "ON" and "OFF" each time the button is pressed.
- [PULSATE]**
- Washes with the water pressure pulsating between soft and strong.
 - The setting changes between "ON" and "OFF" each time the button is pressed.
- [POSITION]**
- You can adjust the position to one of five positions. ([▲] to the front, [▼] to the rear)
 - When you press the button to flush, the position returns to the standard position (3rd position).
 - If you do not want to return the wand to the standard position. (Page 50)
- Note**
- Functions that operate when a button is pressed during [REAR], [SOFT] or [FRONT] cleansing.
 - Sitting back on the toilet seat makes it easier to adjust the wand position and to reduce splashing.

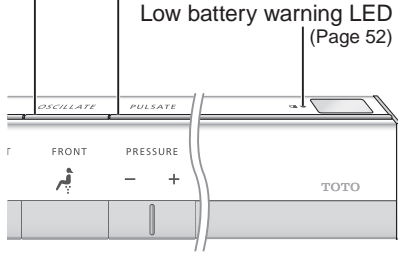

- PERSONAL SETTING**
- [USER1] / [USER2]**
- You can store your preferred wand position, water pressure and water temperature a setting.
- To store a setting
- While cleansing is in progress, set your preferred wand position, water pressure, and warm water temperature, and then press and hold [USER 1] or [USER 2] for 2 seconds or longer.
- To use
- Press [USER 1] or [USER 2], and then press the button for the cleansing you want to use.

When flushing and opening/closing the toilet lid and toilet seat with the remote control

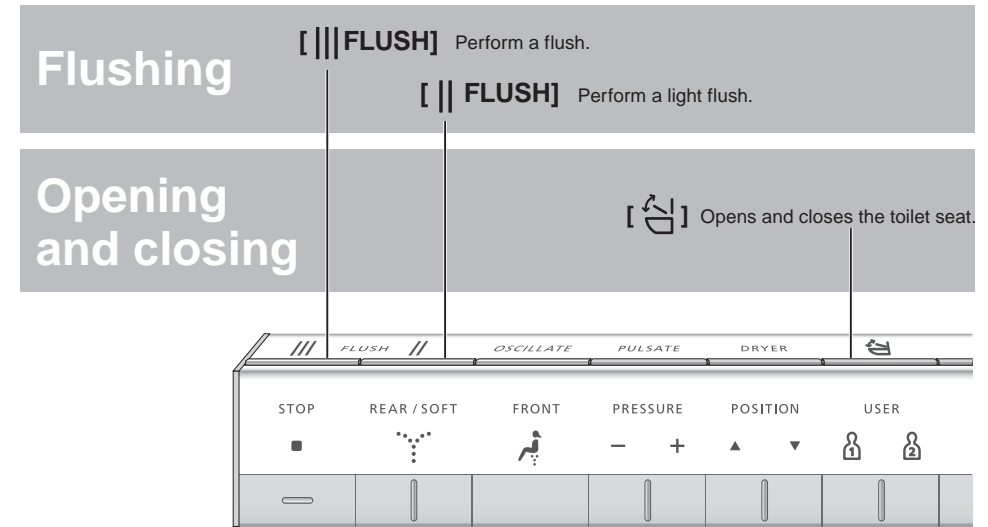

Remote control back side

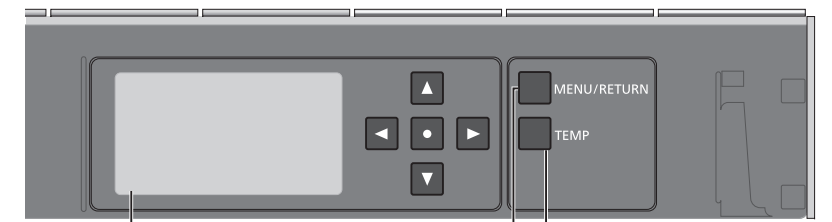

- MENU/RETURN button**
- Adjust settings
 - Return to previous menu
- Display screen**
- Adjust settings, check status, etc.
- The display goes out when no button on the remote control is pressed for 1 minute or more.
- Temperature adjustment button**
- Adjust temperatures

Basic Operations About the Menu Screen

Set up easily with simple steps!

This section is an overview of the settings that can be configured with the remote control.

● See the corresponding pages for the detailed descriptions.

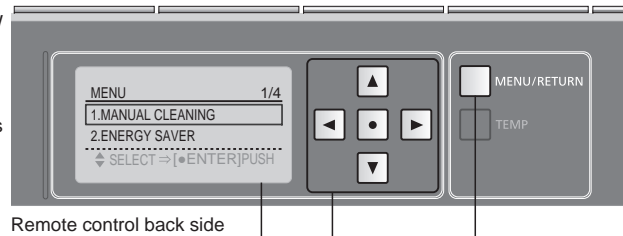

Remote control back side

MENU/RETURN button

- : Select an item
- : Select a setting
- : Confirm

Number of items on display

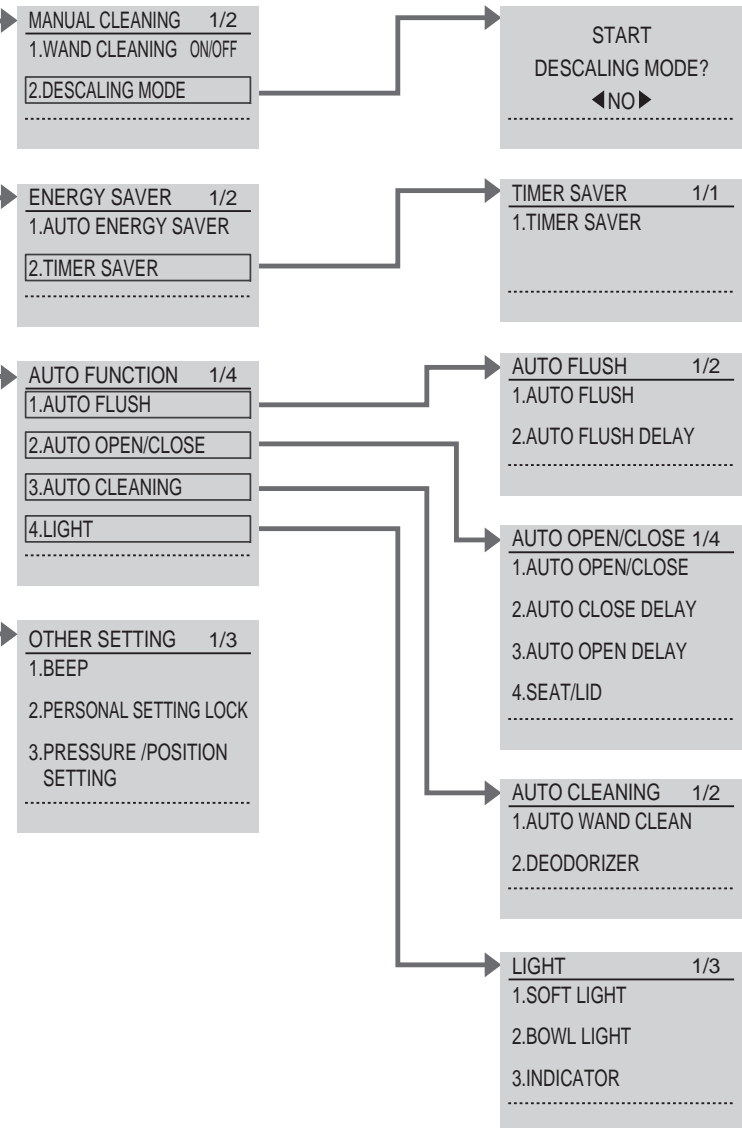
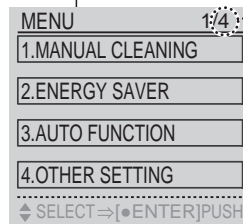

Operation

Automatic Functions Cleaning Features

[ewater+] *1 is used automatically to clean the wand and bowl unit.

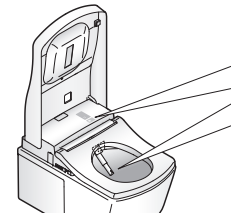

Support Cleaning

- **CLEAN indicator**
Lights to show that the "CLEAN" functions are operating.
- **Bowl light**
Lights to show that auto bowl cleaning and auto wand cleaning are operating.

CLEAN

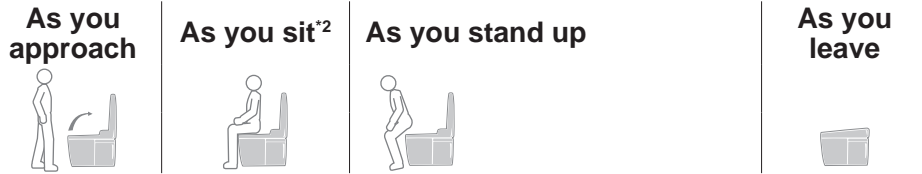

■ **Note**

■ **Changing settings**

DEODORIZER		<p>Starts the deodorizer</p> <p>Deodorizer stops →It stops after about 2 minutes</p>		<ul style="list-style-type: none"> • DEODORIZER ON/OFF (Page 46)
Clean the wand automatically with [ewater+] *1 AUTO WAND CLEANING		<p>Cleans the wand automatically *2 (After about 25 seconds) →The wand extends and [ewater+] *1 comes out from the base of the wand (Only when the cleansing functions are used)</p>	<ul style="list-style-type: none"> • When the cleansing functions have not been used in 8 hours, the wand is cleaned automatically. (Water comes out from near the wand cover.) 	<ul style="list-style-type: none"> • AUTO WAND CLEAN ON/OFF (Page 46)
PHOTOCATALYST CLEANING TCF996 only			<p>The UV lamp lights up (For about 1 hour)</p>	<ul style="list-style-type: none"> • The UV lamp does not light up in the following conditions. →The toilet lid is open (such as when AUTO OPEN/CLOSE is set to "OFF") →"Flush" and cleansing *3 are not used • When the "Flush" and cleansing *3 are not used for about 10 hours, the UV lamp lights up.
Sanitize the bowl unit with [ewater+] *1 AUTO BOWL CLEANING	<p>Pre-mist (A mist is sprayed inside the bowl unit to make it more difficult for dirt to adhere)</p>		<p>After-mist (After auto wand cleaning)</p> <ul style="list-style-type: none"> • If the cleansing functions are not used, after-mist starts after about 25 seconds. →[ewater+] *1 mist is sprayed on the bowl unit 	<ul style="list-style-type: none"> • The pre-mist and after-mist are not sprayed if the toilet seat is open. • The pre-mist does not work for about 90 seconds after the after-mist has finished. • When the cleansing feature (rear and front cleansing etc.) is not used for about 8 hours, mist is sprayed on the bowl unit automatically.
BOWL LIGHT	 (Lights up during pre-mist)	 (Lights up during auto wand cleaning and after-mist)		<ul style="list-style-type: none"> • BOWL LIGHT ON/OFF (Page 48)
INDICATOR	 (Lights up)	 (Lights up in a cycle)	<ul style="list-style-type: none"> • Lights up continuously or in a cycle when "AUTO WAND CLEANING", "AUTO BOWL CLEANING" or "DEODORIZER" is operating. (Lights up in a cycle only when the seat has been used.) 	<ul style="list-style-type: none"> • INDICATOR ON/OFF (Page 48)

If dirt adheres...

■ **If dirt adheres to the wand during use, you can extend the wand to clean it.**
 ● Cleaning the wand (Page 33)

*1 What is meant by [ewater+] ?

This water containing hypochlorous acid generated from chloride ions in tap water, is widely used for cleaning and disinfecting items such as food, utensils and baby bottles.

- Well water may not deliver the required effect. (Because the level of chloride ions is low.)
- Clean, sterile water helps to minimize dirty surfaces, but does not make cleaning unnecessary.
- The effect and duration vary depending on the usage environment and conditions.

Operation

*2 Water comes out from around the wand.
 *3 [FLUSH], [REAR] and [SOFT] cleansing.

Automatic Functions Convenience Features

Various automatic functions are available, such as a toilet lid that opens and closes automatically.

• Operation under the initial settings is described below.



Note

Changing settings

Flush automatically AUTO FLUSH	When using the toilet seat 	When standing-up to urinate 	<p>The toilet flushes. (After about 10 seconds)</p>	<ul style="list-style-type: none"> • Auto flush is not available in the following cases. (Flush with the remote control.) → For about 60 seconds after flushing When a person sits on the toilet seat (or when a male user stands in front of the bowl unit for urinating) for about 6 seconds or less • The flushing varies depending on how long you sit on the toilet seat. About 6 to 30 seconds: "Light flush" About 30 seconds or more: "Flush" 	<ul style="list-style-type: none"> • AUTO FLUSH ON/OFF • AUTO FLUSH DELAY (5 seconds, 10 seconds or 15 seconds) (Page 42)
			<p>The toilet flushes. (Performs a "Light flush" about 3 seconds after the user has moved about 30 cm away from the toilet seat)</p>		
Opening the toilet lid automatically AUTO OPEN/CLOSE	When using the toilet seat <p>Toilet lid opens</p>	<p>Toilet lid closes (About 90 seconds after you stand up from the toilet seat)</p>	<ul style="list-style-type: none"> • When the toilet lid is closed with the remote control or by hand, it cannot open automatically for about 15 seconds. (Open and close manually.) • When you do not sit on the toilet seat, or when you sit on it or stand in front of the bowl unit briefly, it takes about 5 minutes before the lid close automatically. 	<ul style="list-style-type: none"> • AUTO OPEN/CLOSE ON/OFF • AUTO OPEN DELAY (15 seconds, 30 seconds or 90 seconds) • AUTO CLOSE DELAY (25 seconds or 90 seconds) • Automatically opening the toilet lid or both the toilet seat and toilet lid (Page 44) 	
	When standing-up to urinate <p>Toilet lid opens *Open the toilet seat with the remote control.</p>	<p>The toilet lid and toilet seat close (About 90 seconds after the user has moved about 30 cm away from the toilet seat.)</p>			
Lighting up the inside of the bathroom with a soft light SOFT LIGHT	Lights up in middle mode 	Lights up in high mode 	Lights up in middle mode (About 90 seconds)	Lights up in low mode (Goes out after about 5 seconds.)	<ul style="list-style-type: none"> • SOFT LIGHT ON/OFF (Page 48)

Temperature Adjustment Warm Water / Toilet Seat / Drying

You can adjust the temperature levels or turn the settings to "OFF".

1 Remove the remote control from the hanger.

If the remote control is locked to prevent theft (Page 14)

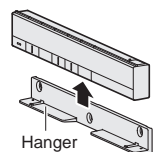

2 Press [TEMP].

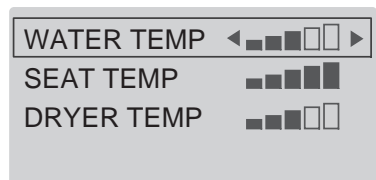

3 Use to select the item you want to set.

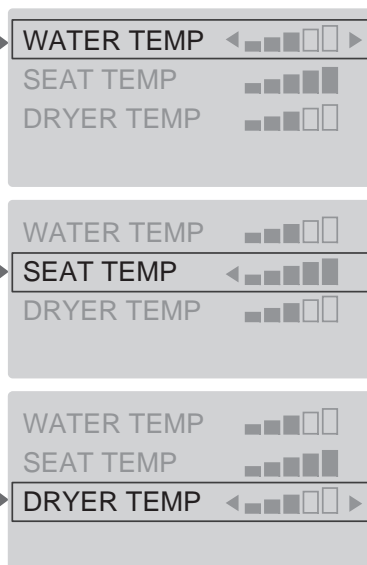

4 Use to select the <Settings temperature level. complete>

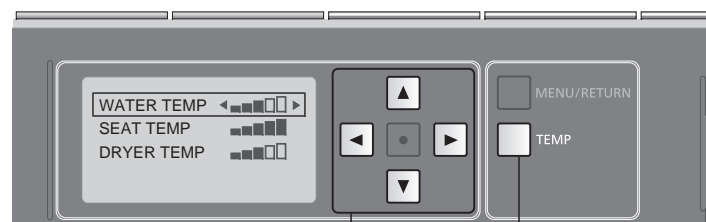
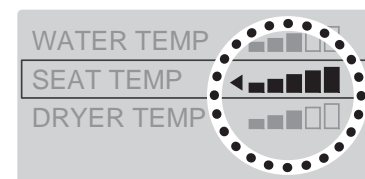

Remote control back side

Temperature adjustment button

- : Select an item
- : Select a setting







Warm water temperature	<p>Press until [OFF] appears.</p>
Toilet seat temperature	<p>Press until [OFF] appears.</p>
Drying air temperature	

*To prevent condensation, the water temperature does not drop below 20°C even when set to "OFF".

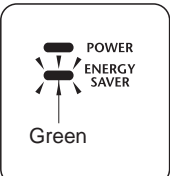
Energy Saver Features Type

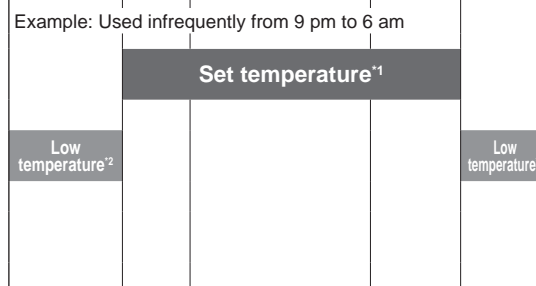
You can save energy by turning the toilet seat heater to a low temperature (or turning the heater "OFF") during periods when the toilet will be used infrequently.

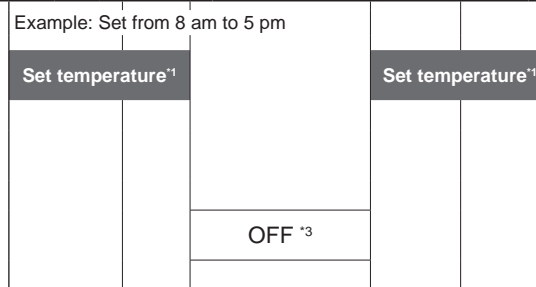
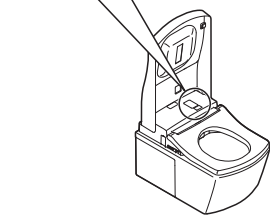
• It takes about 10 days for the product to determine the periods when it is used relatively less frequently.

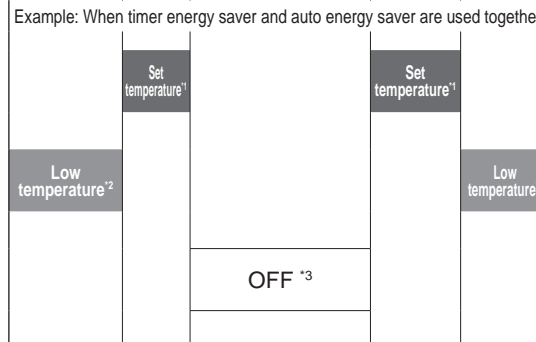
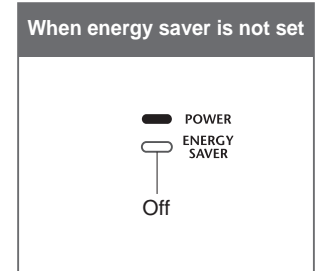
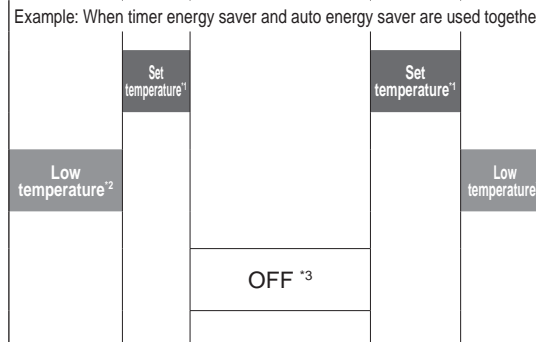
Type	Situation	When energy saver is set	When energy saver is in operation		AM PM					
		Main Display	Toilet seat heater	0	6	8	5	9	0	
AUTO ENERGY SAVER	<p>You want to save energy but dislike a cold toilet seat</p> <p>The NEOREST detects time periods with infrequent use and lowers the toilet seat temperature automatically.</p>			Example: Used infrequently from 9 pm to 6 am 						
					Example: Set from 8 am to 5 pm 					
TIMER ENERGY SAVER	<p>You want to save energy only for the preset duration of time.</p> <p>If you set the duration of time (3 hours, 6 hours or 9 hours) during which you want to save energy, the heater automatically turns off every day in the set time slot.</p>			Example: When timer energy saver and auto energy saver are used together 						
AUTO ENERGY SAVER + TIMER ENERGY SAVER	<p>You want to save a lot of energy with auto energy saver and timer energy saver</p> <p>When both timer energy saver and auto energy saver are set, auto energy saver operates when timer energy saver is not operating.</p>	<p>When energy saver is not set</p> 	<ul style="list-style-type: none"> • During timer energy saver : Same LED indication as timer energy saver (See above) • During auto energy saver : Same LED indication as auto energy saver (See above) 	Example: When timer energy saver and auto energy saver are used together 						

Operation

Note

• Even if the toilet seat heater is set to "Low" or "OFF", the toilet seat is temporarily heated when you sit on it.

*1 The toilet seat temperature set on Page 24.

*2 The time period when the toilet seat heater is set to a low temperature by the auto energy saver.

*3 The time period when the toilet seat heater is "OFF".

Energy Saver Features How to set

Set the timer energy saver at the time you want to start it.

1 MENU/RETURN
Press [MENU].

2
Use to select [ENERGY SAVER] and then press [ENTER].



Remote control back side

MENU/RETURN button

: Select an item

: Select a setting

: Confirm

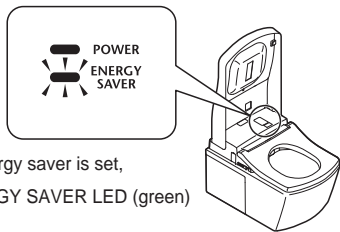

When energy saver is set, the ENERGY SAVER LED (green) lights up.

How to set

AUTO ENERGY SAVER	<p>3 Use to select [AUTO ENERGY SAVER].</p>	<p>4 Use to select [ON] or [OFF] and then press [ENTER].</p> <p style="text-align: right;">(To return → MENU/RETURN)</p>
TIMER ENERGY SAVER	<p>3 Use to select [TIMER SAVER] and then press [ENTER].</p>	<p>4 Use to select [3H], [6H], [9H] or [OFF] and then press [ENTER].</p> <p style="text-align: right;">(To return → MENU/RETURN)</p>
TURNING OFF ENERGY SAVER	<p>Select [OFF] in step 4 in each procedure above and then press [ENTER].</p> <p>(Example)</p>	<p style="text-align: right;">(To return → MENU/RETURN)</p>

■ To change the timer energy saver time → Set the timer energy saver again at the time you want to start it.

Power plug

Power plug (Perform monthly) <Europe and Russia Only>



Dry cloth



Wet cloth

1 Disconnect the power plug and wipe it with a dry cloth.

The power plug is located in the side-panel (right).
(Instructions on removing the side-panel →Page 15)



2 Insert the power plug.

(Instructions on installing the side-panel →Page 15)

! WARNING

! Periodically remove dust from the blades and other parts of the power plug.

- Disconnect the plug and wipe it with a dry cloth.



- Fully insert the power plug.
- When disconnecting, hold the main body of the power plug.
 - Pulling the cord may damage the plug or cord.

! WARNING

- ! Always disconnect the power plug from the outlet before cleaning, maintenance or inspection. (Page 15)
- Always switch the breaker on the distribution board to OFF. (UK)
(Otherwise, it may cause electrical shock or malfunction.)

***For safety, disconnect the power plug before cleaning or maintenance.**

***Switch the breaker on the distribution board to OFF. (UK)**

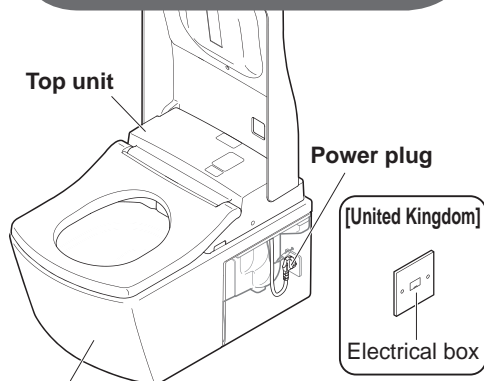

Top unit

Power plug

[United Kingdom]

Electrical box

Bowl unit

Do not use a dry cloth or toilet paper on plastic parts.
(May cause damage.)



*Except when using "Wand cleaning"

*When you insert the power plug, the toilet bowl flushes automatically.

*When you turn on the breaker on the distribution board, the toilet bowl flushes automatically. (UK)

Top unit

Caution with use of detergent

- The NEOREST is an electric appliance. Be careful not to let water seep inside or leave detergent in the gap between the top unit and bowl unit. (May damage plastic parts or cause a malfunction.)
- When using a toilet cleaner to clean the toilet, wash it off within 3 minutes and leave the toilet seat and toilet lid open.
 - Wipe off any cleaner that remains on the toilet bowl. (If vapor from a toilet bowl cleaner enters the top unit, it may cause a malfunction.)
- Do not use any water repellent, stain-proofing cleaner or surface coating agent. These products would not damage the porcelain surface, but they may cover the porcelain surface and reduce the effect of the built-in stain prevention technology.

Top Unit (Perform daily)



Soft cloth soaked in water

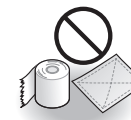

- Toilet paper
- Dry cloth
- Nylon scrubbing pads
(May cause damage.)

1 Unplug the power plug. (Page 15) Switch the breaker on the distribution board to OFF. (UK)

2 Wipe with a soft cloth that has been soaked in water and wrung-out thoroughly.

■ For heavy dirt

- Wipe with a soft cloth soaked in diluted, neutral kitchen detergent, and then wipe with a soft cloth soaked in water.



• Neutral kitchen detergent



- Paint thinner
- Benzene
- Powdered cleanser

3 Insert the power plug. (Page 15) Switch the breaker on the distribution board to ON. (UK)

Attention!

- Do not push or pull the wand cover or the warm air dryer cover with undue force.
(May cause damage or malfunction.)

Bowl unit (Perform daily)



- Toilet brush
- Neutral toilet detergent



- Strongly acidic cleaners or strong alkaline cleaners
- Cleaners containing abrasive compounds
- Fluoride-based detergent (containing hydrogen fluoride or ammonium fluoride)
- Wire brush
- Abrasive nylon scrubbing brush

1 Unplug the power plug. (Page 15)
Switch the breaker on the distribution board to OFF. (UK)

2 Clean with a toilet brush or a similar tool.
■ **If the bowl unit is clogged**

- Using a manual pump or the like, provide 10 cm or more clearance between the top of the bowl unit and the water surface.
- Use commercially available tools that are made for unclogging the toilet bowl. (May cause overflow of dirty water and water damage.)

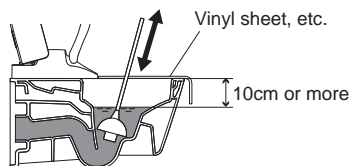

■ **If the floor is dirty**

- Clean it with a well wrung cloth. (Not cleaning the floor may cause stains or corrosion.)
- Using the product while standing may cause splashing. To reduce splashing, use the product while seated.

3 Insert the power plug. (Page 15)
Switch the breaker on the distribution board to ON. (UK)

Bowl Unit*¹ (Approximately once a month)

- To preserve the performance of the photocatalyst cleaning, clean the toilet bowl surface with a toilet brush, etc. using commercially available hydrochloric acid-based or inorganic acid-based detergent.

*1 Other than the TCF994

Wand (Perform monthly)

<Wand cleaning> If you notice dirt



Soft cloth

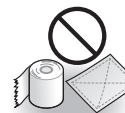

Toilet paper, etc.
(May cause damage.)

1 Extend the wand.

- Operate with the buttons on the back side of the remote control.

(1) MENU/RETURN Press [MENU].

(2) Use to select [MANUAL CLEANING].

Press [ENTER].

(3) Use to select [WAND CLEANING ON/OFF].

Press [ENTER].

- The wand extends and water sprays out for cleaning.
- The wand automatically retracts after about 5 minutes.

2 Wipe with a soft, wet cloth.

- Do not pull, push or press the wand with excessive force. (May cause damage or malfunction.)

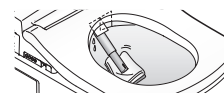

3 Press [STOP] on the front side of the remote control.

- The wand retracts.

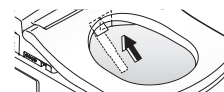

Deodorizing filter (Perform monthly)

<If you notice odors>

1 Unplug the power plug. (Page 15)
Switch the breaker on the distribution board to OFF. (UK)

2 Remove the deodorizing filter.
• Use the notch of the deodorizing filter to pull it out.
• Do not pull with undue force. (May cause damage or malfunctions)

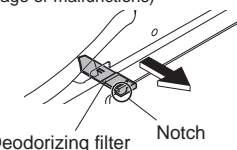

3 Clean with a tool such as a toothbrush.

- When washing with water, dry off all water before mounting.

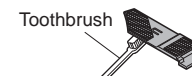

4 Mount the deodorizing filter.
• Push firmly until a click sound is heard.

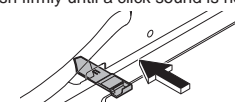

5 Insert the power plug. (Page 15)
Switch the breaker on the distribution board to ON. (UK)



Maintenance Descaling mode

Descaling mode

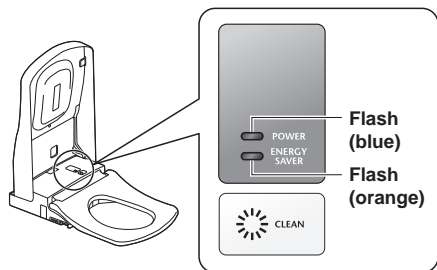

Please perform
Descaling mode

Items to prepare

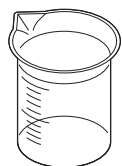

Beaker
(included item)



Funnel
(included item)

Descaling agent (TOTO specified)

Attention!

- Please use one of the following descaling agents at specified concentration. (Failure to do so may cause damage)
- If you wish to use other agents, please contact us at the phone number on the back of this manual.

Product name	Manufacturer
Sido® Universal-Entkalker (liquid) Bref POWER® Universal-Entkalker (liquid) Oust® ALL PURPOSE DESCALER (liquid)	Henkel AG & Co. KGaA

How to dilute

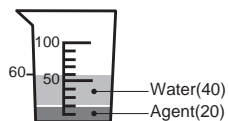

Pour and mix thoroughly

■ If the beaker is missing

Please use a clean cup and dilute 20ml of agent with 40ml of water.

Product name	Manufacturer
swirl® Anti Calc Bio Power Concentrate swirl® Anti Calc Bio flüssig swirl® Жидкий очиститель от накипи CITRUS-CLEAN	Melitta Group

How to dilute

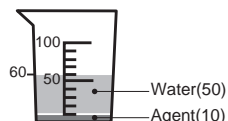

Pour and mix thoroughly

■ If the beaker is missing

Please use a clean cup and dilute 10ml of agent with 50ml of water.

[SIDOL], [Bref POWER] and [OUST] are registered trademarks of [Henkel AG & Co. KGaA].
[swirl] is a trademark of company of the [Melitta Group].

<If you think the water pressure has weakened>
<When [POWER] LED (blue) and [ENERGY SAVER] LED (orange) flash>

Note

- (Rear, bidet and soft) cleansing modes cannot be used from step 2 "Drain water passage" until 60 minutes after step 9 "Descaling (2nd time)" is performed. (Toilet can be flushed)
- Lid will not open automatically from step 2 "Drain water passage" until 10 minutes after step 9 "Descaling (2nd time)" is performed. Please open manually.
- If the work is delayed for more than 30 minutes between steps 2 and 9, descaling agent will be drained to the toilet with a long beep sound to alert.
- If you wish to restart, please wait for 30 minutes and go back to step 1.

1 SET DESCALING MODE.

- Operate with the buttons on the back side of the remote control.

(1) Press MENU/RETURN [MENU].

(2) Use to select [MANUAL CLEANING].

Press [ENTER].

(3) Use to select [DESCALING MODE].

Press [ENTER].

The display changes to [START DESCALING MODE?]

Remote control display

```
MENU 1/4
1.MANUAL CLEANING
2.ENERGY SAVER
SELECT=>[ENTER]PUSH
```

```
MANUAL CLEANING 1/2
1.WAND CLEANING ON/OFF
2.DESCALING MODE
SELECT=>[ENTER]PUSH
```

```
MANUAL CLEANING 2/2
1.WAND CLEANING ON/OFF
2.DESCALING MODE
SELECT=>[ENTER]PUSH
```

```
START
DESCALING MODE?
<NO>
SELECT=>[ENTER]PUSH
```

Descaling mode

2 Drain water passage.

- (1) Use to select [YES].
 Press [ENTER].

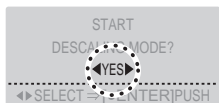

Water passage is drained (for about 30 seconds.)

- You will hear short beep sound while the work is in progress, and a long beep sound upon completion.
- Water comes out from around the wand.
- [POWER] LED (blue) and [ENERGY SAVER] LED (green) will flash. (The LEDs will continue to flash until the completion of entire descaling work)

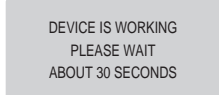

- (2) When the beep stops
 Press [ENTER].

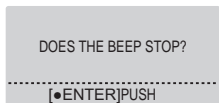

Attention!

- The display shows [DESCALING MODE FILL IN THE DESCALING AGENT (1/2)], but please DO NOT press [ENTER] until you have completed filling in descaling agent. (Descaling will not work correctly)

3 Dilute agent with water. (1st time)

(Please see **How to dilute** on page 34.)

4 Remove cover and cap on the top face of product.

Attention!

- Please retain cover and cap.

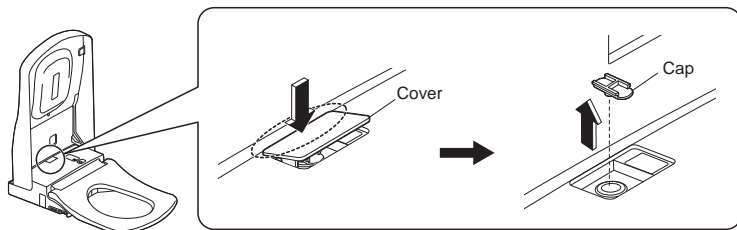

<If you think the water pressure has weakened>

<When [POWER] LED (blue) and [ENERGY SAVER] LED (orange) flash> (Continued)

5 Insert funnel and pour diluted agent. (1st time)

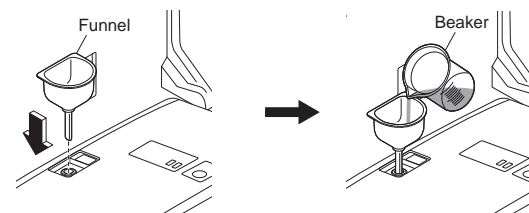

Attention!

- Please wait until funnel is empty. (Descaling will not work correctly)

6 Perform descaling. (1st time)

- (1) Press [ENTER].

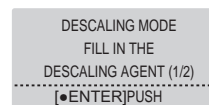

Descaling will be performed (for about 30 seconds)
 • You will hear short beep sound while the work is in progress, and a long beep sound upon completion
 • Water comes out from around the wand and mist nozzle.



- (2) When the beep stops
 Press [ENTER].

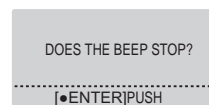

Attention!

- The display shows [DESCALING MODE FILL IN THE DESCALING AGENT (2/2)], but please DO NOT press [ENTER] until you have completed filling in descaling agent. (Descaling will not work correctly)

7 Dilute agent with water. (2nd time)

(Please see **How to dilute** on page 34.)

8 Pour diluted agent. (2nd time)

(Please see **5** on page 37.)

Attention!

- Please wait until funnel is empty. (Descaling will not work correctly)

Descaling mode

Descaling mode

<If you think the water pressure has weakened>
<When [POWER] LED (blue) and [ENERGY SAVER] LED (orange) flash> (Continued)

- 9** Remove the funnel and put cap and cover back on.

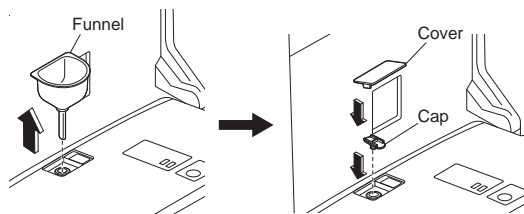

Attention!

- Please wipe off any spilt agent with soft wetted cloth (Failure to do so may cause discoloration)

- 10** Perform descaling. (2nd time)

● Press [●ENTER].

Descaling will be performed (for about 60 minutes)

- Water will be sprayed from around the wand and mist nozzle at about 20-minute intervals

↓

After about 60 minutes, descaling agent will be drained to the toilet

↓

After draining, you will hear a long beep sound, and the LEDs on product main body stop flashing

↓

<Descaling complete>

DESCALING MODE
FILL IN THE
DESCALING AGENT (2/2)
[●ENTER]PUSH

DESCALING IN
PROGRESS
PLEASE WAIT FOR
60 MINUTES

Returns to default display in about 30 seconds.

Attention!

- If the spray is still weak after performing **Descaling mode**, please clean **Water filter drain valve**.
- If the symptom does not improve after conducting **Descaling mode** and cleaning **Water filter drain valve** or if the [POWER](blue) and [ENERGY SAVER](orange)LEDs start to flash, please perform **Descaling mode** again.

Water Filter Drain Valve

Water Filter Drain Valve

(Perform once every 6 months)
<If you think the water pressure has weakened>

- 1** Remove the side-panel (left).
(Page 15)

- 2** Close the shutoff valve.
● The water supply stops.

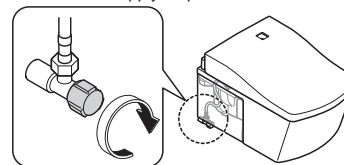

CAUTION

Do not remove the water filter drain valve while the shutoff valve is open.
(Otherwise, water may leak out)

- 3** Extend the wand.
● Operate with the buttons on the back side of the remote control.

(1) MENU/RETURN Press [MENU].

(2) Use to select [MANUAL CLEANING].

(3) Press [●ENTER].

Use to select [WAND CLEANING ON/OFF].

Press [●ENTER] to extend the wand.

Press [●ENTER] again to retract the wand.

(Release the pressure from the water supply pipe.)

- 4** Unplug the power plug. (Page 15)
Switch the breaker on the distribution board to OFF. (UK)

- 5** Remove the cover and water filter drain valve.
● Loosen with a flat-head screwdriver and then pull.

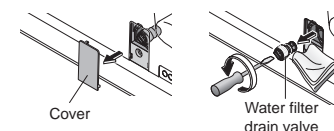

- 6** Clean with a tool such as a toothbrush.
● Also, remove any dust from inside the hole of the water filter drain valve.

- 7** Reinstall the water filter drain valve and cover.
● Insert the water filter drain valve and tighten it securely with a flat-head screwdriver.

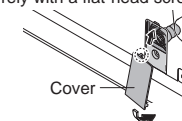

- 8** Insert the power plug. (Page 15)
Switch the breaker on the distribution board to ON. (UK)

- 9** Open the shutoff valve.
(Page 15)

- 10** Reinstall the side-panel (left).
(Page 15)

Changing Settings Setting List



Remote control back side

Setting Types			Available Settings*	Setting Ref. Page	
AUTO FUNCTIONS	AUTO FLUSH	AUTO FLUSH	• Set whether or not to clean the bowl unit automatically	ON/OFF	Page 42
		AUTO FLUSH DELAY	• Change the amount of time before the toilet flushes automatically	5S/10S/15S	
	AUTO OPEN/CLOSE	AUTO OPEN/CLOSE	• Set whether or not to open the toilet lid automatically	ON/OFF	Page 44
		AUTO CLOSE DELAY	• Change the amount of time before the lid/seat closes automatically	25S/90S	
		AUTO OPEN DELAY	• Change the amount of time after which the lid/seat opens automatically upon closing it with hands	15S/30S/90S	
		SEAT/LID	• Automatically open and close the toilet lid/ Automatically open and close the toilet seat and toilet lid	LID/SEAT-LID	
	AUTO CLEANING	AUTO WAND CLEAN	• Set whether or not to clean the wand automatically	ON/OFF	Page 46
		DEODORIZER	• Set whether or not to deodorize automatically after sitting on the toilet seat	ON/OFF	
	LIGHT	SOFT LIGHT	• Set whether or not to use the soft light	ON/OFF	Page 48
		BOWL LIGHT	• Set whether or not to use the light inside the bowl unit	ON/OFF	
INDICATOR		• Set whether or not to light up the CLEAN indicator	ON/OFF		
OTHER SETTINGS	BEEP		• Set whether or not to make a beep sound	ON/OFF	Page 50
	PERSONAL SETTING LOCK		• Set whether or not to use the personal setting lock	ON/OFF	
	PRESSURE/POSITION SETTING		• Set whether or not to keep your favorite pressure and position settings	ON/OFF	

*The black text is the initial setting.

Changing Settings

AUTO FLUSH

1 MENU/RETURN
Press [MENU].

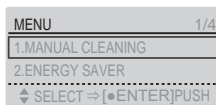

2
Use to select [AUTO FUNCTION] and then press [ENTER].

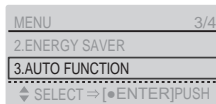

3
Use to select [AUTO FLUSH] and then press [ENTER].

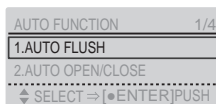

Set whether or not to clean the bowl unit automatically
AUTO FLUSH

4 Use to select [AUTO FLUSH].

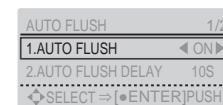

5 Use to select [ON/OFF] and then press [ENTER].

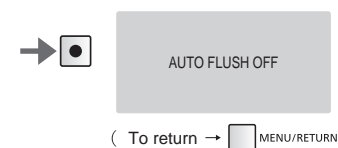
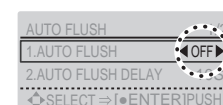

Select the amount of time (5 seconds, 10 seconds or 15 seconds) after which the toilet bowl flushes automatically
AUTO FLUSH DELAY*

4 Use to select [AUTO FLUSH DELAY].

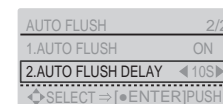

5 Use to select [5S], [10S] or [15S] and then press [ENTER].

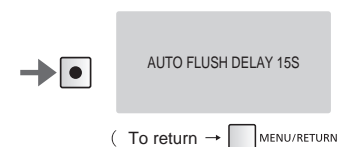
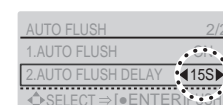

*This operation is not available when the AUTO FLUSH is "OFF".

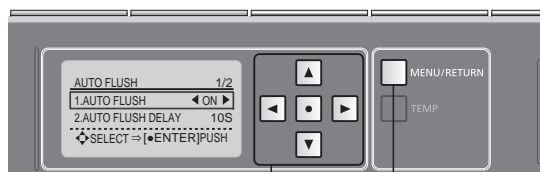

Remote control back side

MENU/RETURN button

: Select an item

: Select a setting

: Confirm

Items set on this display

- 1. AUTO FLUSH
- 2. AUTO FLUSH DELAY

Changing Settings

AUTO OPEN / CLOSE

1 MENU/RETURN
Press [MENU].

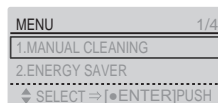

2
Use to select [AUTO FUNCTION] and then press .

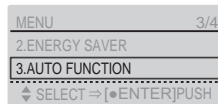

3
Use to select [AUTO OPEN/CLOSE] and then press .

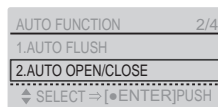

Use to select [AUTO OPEN/CLOSE] and then press .

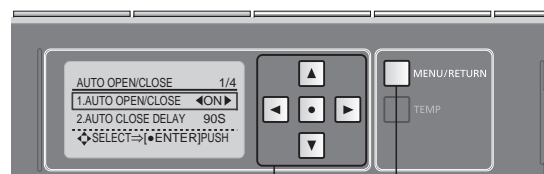

Remote control back side

MENU/RETURN button

: Select an item

: Select a setting

: Confirm

Items set on this display

1. AUTO OPEN/CLOSE
2. AUTO CLOSE DELAY
3. AUTO OPEN DELAY
4. SEAT/LID

<p>Set whether or not to open the toilet lid automatically^{*1}</p> <h3>AUTO OPEN/CLOSE</h3>	<p>4 Use to select [AUTO OPEN/CLOSE].</p> <p>5 Use to select [ON/OFF] and then press .</p> <p>(To return → MENU/RETURN)</p>
<p>Change the time before the lid/seat closes automatically (25 SEC or 90 SEC)^{*3}</p> <h3>AUTO CLOSE DELAY^{*2}</h3>	<p>4 Use to select [AUTO CLOSE DELAY].</p> <p>5 Use to select [25S] or [90S] and then press .</p> <p>(To return → MENU/RETURN)</p>
<p>Change the time period till automatic opening (15 SEC, 30 SEC or 90 SEC) (After closing manually.)</p> <h3>AUTO OPEN DELAY^{*2}</h3>	<p>4 Use to select [AUTO OPEN DELAY].</p> <p>5 Use to select [15S], [30S] or [90S] and then press .</p> <p>(To return → MENU/RETURN)</p>
<p>Automatically open and close the toilet lid only/ Automatically open and close the toilet seat and toilet lid^{*4}</p> <h3>SEAT/LID^{*2}</h3>	<p>4 Use to select [SEAT/LID].</p> <p>5 Use to select [LID] or [SEAT-LID] and then press .</p> <p>(To return → MENU/RETURN)</p>

^{*1} When AUTO OPEN/CLOSE is set to "OFF", UV light does not work while the lid is open. Please close with your hands. (TCF996 only)

^{*2} This operation is not available when the AUTO OPEN/CLOSE is "OFF".

^{*3} When set to 25 seconds, the lid/seat does not open automatically for about 15 seconds after closing automatically.

^{*4} When the toilet seat and toilet lid are set to open automatically, pre-mist is not sprayed.

Changing Settings

AUTO CLEANING

1 MENU/RETURN
Press [MENU].

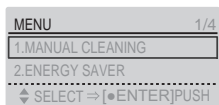

2
Use to select [AUTO FUNCTION] and then press [ENTER].

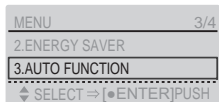

3
Use to select [AUTO CLEANING] and then press [ENTER].

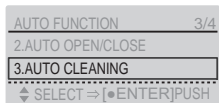

Set whether or not to clean the wand automatically
AUTO WAND CLEAN

4
Use to select [AUTO WAND CLEAN].



5
Use to select [ON/OFF] and then press [ENTER].

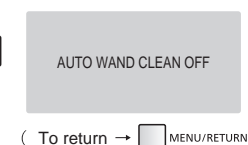
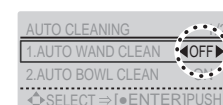

Set whether or not to deodorize automatically after sitting on the toilet seat
DEODORIZER

4
Use to select [DEODORIZER].

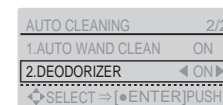

5
Use to select [ON/OFF] and then press [ENTER].

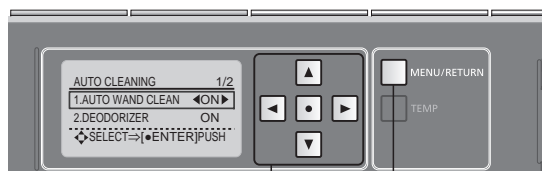
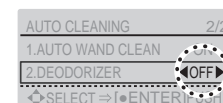

Remote control back side

MENU/RETURN button

: Select an item

: Select a setting

: Confirm

Items set on this display

1. AUTO WAND CLEAN
2. DEODORIZER

Changing Settings

LIGHT

1 MENU/RETURN
Press [MENU].

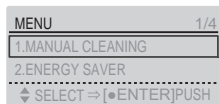

2
Use to select [AUTO FUNCTION] and then press .

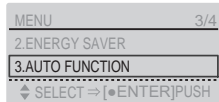

3
Use to select [LIGHT] and then press .

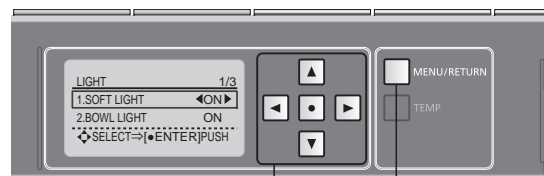
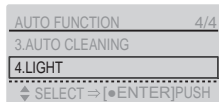

Remote control back side

MENU/RETURN button

- : Select an item
- : Select a setting
- : Confirm

Items set on this display

1. SOFT LIGHT
2. BOWL LIGHT
3. INDICATOR

SOFT LIGHT

Set whether or not to use the soft light

4 Use to select [SOFT LIGHT].

5 Use to select [ON/OFF] and then press .

(To return → MENU/RETURN)

BOWL LIGHT

Set whether or not to use the light inside the bowl unit

4 Use to select [BOWL LIGHT].

5 Use to select [ON/OFF] and then press .

(To return → MENU/RETURN)

INDICATOR

Set whether or not to light up the CLEAN indicator

4 Use to select [INDICATOR].

5 Use to select [ON/OFF] and then press .

(To return → MENU/RETURN)

Changing Settings

OTHER SETTING

1 MENU/RETURN
Press [MENU].

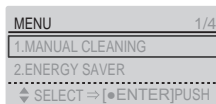

2
Use to select [OTHER SETTING] and then press [ENTER].

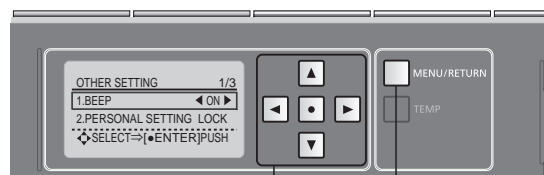
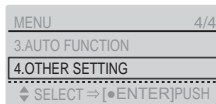

Remote control back side

MENU/RETURN button

: Select an item

: Select a setting

: Confirm

Items set on this display

1. BEEP
2. PERSONAL SETTING LOCK
3. PRESSURE/POSITION SETTING

Set whether or not to make a beep sound
BEEP

3 Use to select [BEEP].

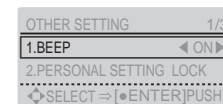

4 Use to select [ON/OFF] and then press [ENTER].

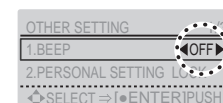

(To return → MENU/RETURN)

Set whether or not to use the personal setting lock
PERSONAL SETTING LOCK

3 Use to select [PERSONAL SETTING LOCK].

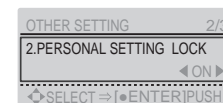

4 Use to select [ON/OFF] and then press [ENTER].

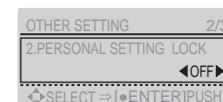

(To return → MENU/RETURN)

Set to keep your favorite pressure and position settings for future use
PRESSURE/ POSITION SETTING

3 Use to select [PRESSURE/ POSITION SETTING].

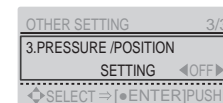

4 Use to select [ON/OFF] and then press [ENTER].

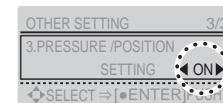

(To return → MENU/RETURN)

What to Do?

If there is no water due to a power outage or water failure

■ If a power outage occurs

Press the button on the flush panel to flush.

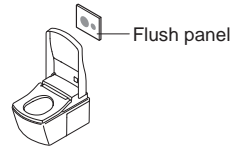

■ If a water outage occurs

1 Use a bucket to flush water.

2 If the water level is low after flushing, add more water.
(Prevents odors.)

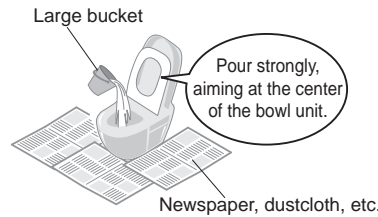

Attention!

- If there is a water supply failure, set the auto bowl unit cleaning to "OFF".
- When the water supply is restored, be sure to perform a flush.
(To prevent waste from remaining in the drain pipe.)

If you cannot operate with the remote control

■ Operation is also possible using the buttons on the control panel.

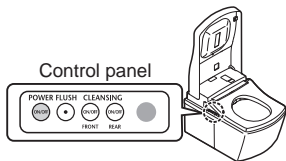

■ If the low battery warning LED is flashing, replace the batteries.

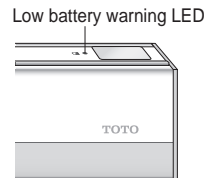

■ Replacing the batteries

1 Press [POWER ON/OFF] on the control panel.
The POWER LED goes off.

2 Remove the remote control from the hanger.
(Page 14)

3 Open the cover and replace the AA batteries.
(Page 14)

4 Mount the remote control in the hanger.

5 Press [POWER ON/OFF] on the control panel.
The POWER LED lights up.

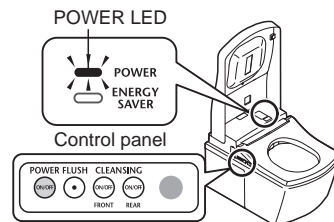

What to Do?

Freeze Damage Prevention

When the ambient temperature is likely to drop to 0°C or lower, take measures to prevent freezing.

Attention!

- When the ambient temperature is likely to drop to 0°C or lower, do not use the energy saver feature. (May damage the product.)
- Warm the bathroom or take measures against freeze so that the ambient temperature does not drop below 0°C.
- Before starting work, set "AUTO FLUSH" (Page 42) and "AUTO OPEN/CLOSE" (Page 44) to "OFF".

Anti freezing

■ How to drain the water

1 Remove the side-panel (left) and close the shutoff valve.

(Page 15, Page 55)

2 Drain the pipe.

(1) Extend the wand.

Operate with the buttons on the back side of the remote control.

1. Press [MENU].

2. Use to select [MANUAL CLEANING].

3. Press [ENTER].

Use to select [WAND CLEANING ON/OFF].

Press [ENTER] to extend the wand.

• Hold the wand in the extended position until no more water comes from around the wand.

Press [ENTER] again to retract the wand.
(Release the pressure from the water supply pipe.)

(2) Unplug the power plug. (Page 15)
Switch the breaker on the distribution board to OFF. (UK)

(3) Remove the cover and water filter drain valve.

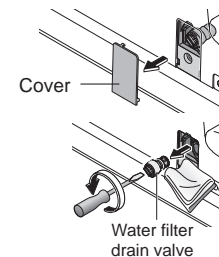

(4) After draining the water, install the water filter drain valve and cover.
Insert the water filter drain valve and use a flat-head screwdriver to tighten it securely.

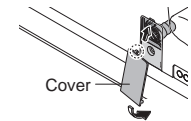

(5) Insert the power plug. (Page 15)
Switch the breaker on the distribution board to ON. (UK)

3 Check that the POWER LED on the main display is lit up. (Page 15)

4 Set the toilet seat temperature to "High". (Page 24)
(To maintain the temperature.)
• When finished, close the toilet seat and toilet lid.

5 Reinstall the side-panel (left).
(Page 15)

■ To use the NEOREST again

- The water needs to be replenished. (Page 54)

What to Do? Long Periods of Disuse

If the toilet is in a location you will not visit for a long time, drain the water.
(The water in the tank may become contaminated and cause skin irritation or other problems.)

How to drain the water

- 1** Remove the side-panel (left) and close the shutoff valve.
(Page 15, Page 55)
- 2** Drain the pipe.
(Step **2** (1) to (4) on Page 53)
- 3** Pull out the water drain lever.
The water comes out from near the wand for about 20 seconds.
- 4** Release your hand to return the water drain lever to its original position.
- 5** Reinstall the side-panel (left).
(Page 15)
- 6** Take appropriate measures for the water remaining in the bowl unit.
Putting antifreeze in the water remaining in the toilet bowl will reduce its chance of freezing.

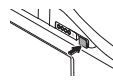
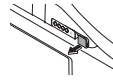

- **To use the NEOREST again**
 - The water needs to be replenished. (See right)

Resupplying the Water (After draining)

- 1** Open the shutoff valve.
Check that water is not leaking from a pipe or the top unit.
- 2** If the power is not turned ON insert it. (Page 15)
Switch the breaker on the distribution board to ON. (UK)
- 3** Discharge water from the wand.
 - (1) Pressing down the left side of the toilet seat,
 - (2) Press the [REAR] on the remote control to discharge water from the wand. (Catch the water in a paper cup or other receptacle)
 - **If the remaining water has frozen and no water comes out**
 - Heat the inside of the bathroom, and warm the water supply hose and shutoff valve using a cloth soaked in warm water.

Troubleshooting

First, try the actions described on pages 55 to 62. If the problem persists, consult the installer, seller or the contact listed on the back cover of this manual.

- **The CLEAN indicator does not light up.** (It is time for parts replacement. → Page 61)

CAUTION

! If a water leak occurs, close the shutoff valve.

Please check first

Is the **POWER LED** lit?

- **Does the LED light up when you press [POWER ON/OFF] on the top unit?**

- **Is the breaker on the distribution board turned on?**

→ Check whether there is a power outage or the breaker has turned "OFF".

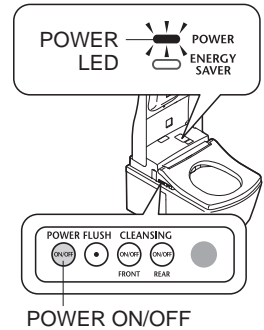

Is the **ENERGY SAVER LED** lit?

- **While the LED is lit, energy saver (Page 26) is in operation, so the toilet seat temperature may be reduced or the heater may be turned off.**

Is the remote control working?

- **Is the Low Battery Warning LED on the top surface of the remote control flashing?**

→ Replace the batteries. (Page 52)

- **Is the remote control transmitter or the remote control receiver blocked?**

→ Remove obstructions, dirt, water droplets or any other blockages.

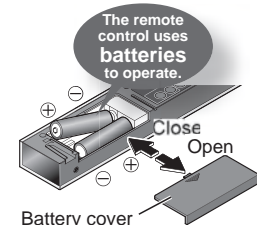

Remote control transmitter

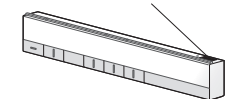

Remote control receiver

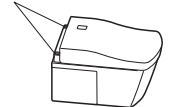

Troubleshooting

Rear and front cleansing, wand		
Trouble	Please check	Ref. Page
The wand (or cleansing water) does not come out	<ul style="list-style-type: none"> Can you operate with the control panel? (Check while sitting on the toilet seat.) → Check "Is the remote control working?" 	12 55
	<ul style="list-style-type: none"> When the temperature is low, it takes time for the wand to come out after the remote control button is pressed because the water must be warmed up first. 	-
	<ul style="list-style-type: none"> Did you sit on the toilet continuously for 2 hours or longer? (If so, operation is stopped for safety purposes.) → Stand up from the seat and then use again. 	-
	<ul style="list-style-type: none"> If the water supply pressure drops significantly, for example if water is used elsewhere or if there is a water failure, the function may stop for safety. → Disconnect the power plug and wait about 10 seconds before inserting it again. Switch the breaker on the distribution board to OFF and wait about 10 seconds before inserting it again. (UK) If the same symptom reappears → There may be a malfunction. Consult with the contact listed on the back cover of this manual. 	-
	<ul style="list-style-type: none"> The seat sensor may have difficulty detecting some sitting postures. → Sit back on the toilet seat. 	11
	<ul style="list-style-type: none"> Are you using a toilet seat cover, a toilet lid cover or a seat for infants? → Remove any covers. When using a seat for infants or a soft highchair, remove after each use. 	11
The wand extends but the cleansing water does not come out / The cleansing water pressure is weak	<ul style="list-style-type: none"> Has a water failure occurred? → Press the [STOP] button and wait until water service is restored. 	-
	<ul style="list-style-type: none"> Is the shutoff valve closed? 	15
	<ul style="list-style-type: none"> Is the Wand clogged? → Please perform Descaling mode. 	34
	<ul style="list-style-type: none"> Is the water filter drain valve clogged with foreign matter? → Clean the filter. 	39
The cleansing water is cold	<ul style="list-style-type: none"> Is the water temperature set to "OFF" or a low level? 	24
	<ul style="list-style-type: none"> When the temperature of the water supply or the bathroom is low, the water temperature may be low when first sprayed. 	-
Stops in the middle of use	<ul style="list-style-type: none"> Rear, rear soft and front cleansing stop automatically after 5 minutes of continuous use. After that, the POWER LED (blue) and the ENERGY SAVER LED (green) on the display of the top unit flicker for about 60 sec. in order to prepare hot water. → Wait until the LEDs on the display of the top unit light up solidly and then press the button again. 	-
	<ul style="list-style-type: none"> Does the seat switch have difficulty detecting? → Sit back on the toilet seat. If you get up slightly from the seat, or sit forward on the seat, the seating switch may temporarily stop detecting your presence. 	11
Water comes out unexpectedly from the wand	<ul style="list-style-type: none"> Water comes out from the area around the wand for several seconds after you sit on the toilet seat. Has the CLEAN indicator lit up in a cycle? <ul style="list-style-type: none"> The wand is cleaned with [water+]. 	20

Warm air drying		
Trouble	Please check	Ref. Page
The dryer temperature is low	<ul style="list-style-type: none"> Is the remote control preset temperature set to a low level? 	24
Stops in the middle of use	<ul style="list-style-type: none"> The feature stops automatically after 10 minutes of continuous use. Does the seat switch have difficulty detecting? → Sit back on the toilet seat. If you get up slightly from the seat, or sit forward on the seat, the seating switch may temporarily stop detecting your presence. 	- 11
Flushing		
Trouble	Please check	Ref. Page
The toilet does not flush even when the button is pressed	<ul style="list-style-type: none"> Are you pressing the button repeatedly? • [FLUSH] button cannot be used to activate a flush repeatedly. After about 20 sec. pass, press the button again. 	-
	<ul style="list-style-type: none"> Is water available from the water supply? → Use a bucket full of water to flush. 	52
The bowl unit does not clean automatically or timing is delayed (Auto bowl unit cleaning)	<ul style="list-style-type: none"> Is "AUTO FLUSH" set to "OFF"? → Set to "ON". Even if "AUTO FLUSH" is set to "ON", it is not available in the following instances. <ul style="list-style-type: none"> 60 seconds after the toilet is flushed → After 60 seconds have passed, flush using the remote control. When the amount of time seated on or standing in front of toilet seat is about six seconds or less → Flush with the remote control. After using the toilet while standing and not moving away from the front of the toilet. → Step away from the toilet and wait for about three seconds. When water droplets or dirt are disrupting the body sensor. → Remove the dirt. The seat sensor may have difficulty detecting some sitting postures. → Sit back on the toilet seat. 	42 22 11 11
	<ul style="list-style-type: none"> The timing for the auto bowl unit cleaning can be changed. (After about 10 seconds → after about 5 or 15 seconds) 	42
	<ul style="list-style-type: none"> Is "AUTO FLUSH" set to "ON"? Does the seat switch or the body sensor have difficulty turning on or detecting? → Sit back on the toilet seat. If you lift your hip off the toilet seat during use or sit forward on it, the seat switch may not turn on, and thus auto flushing may occur during use. → Remove any dirt that is on the body sensor. 	42 11
	<ul style="list-style-type: none"> When you insert the power plug into the outlet, the toilet bowl flushes automatically. When you turn on the breaker on the distribution board, the toilet bowl flushes automatically. (UK) 	-

Troubleshooting

Flushing		
Trouble	Please check	Ref. Page
Waste material does not flush down completely	<ul style="list-style-type: none"> ● Is the water supply to the toilet disrupted by other running water fixtures? → Cease using other fixtures and then flush the toilet. 	-
	<ul style="list-style-type: none"> ● Are the flush and light flush buttons being used correctly? <ul style="list-style-type: none"> • Flush (for solid waste): Up to 10 m of toilet paper (single) • Light flush (for liquid waste): Up to 3 m of toilet paper (single) 	17
	<ul style="list-style-type: none"> ● Flushing may be difficult depending the consistency of the waste material. → Flush the toilet again. If the bowl unit is not cleansed with a flushing, remove the stains with a brush or similar instrument. 	-
Some barium remains after flushing	<ul style="list-style-type: none"> ● It may be difficult to flush down substances with a higher specific gravity than water, such as barium. → Flush the toilet again. If the bowl unit is not cleansed with a flushing, remove the stains with a brush or similar instrument. 	-
There is residue on the bowl unit surface	<ul style="list-style-type: none"> ● Oil and other hard-to-see grime may stick to the bowl unit surface. → Clean the bowl with (non-abrasive) neutral toilet detergent. 	32

Toilet Seat and Toilet Lid (AUTO OPEN/CLOSE)		
Trouble	Please check	Ref. Page
The toilet lid does not open automatically	<ul style="list-style-type: none"> ● Is "AUTO OPEN/CLOSE (LID)" set to "OFF"? → Set to "ON". ● Does the body sensor have difficulty detecting? → Remove any dirt that is on the body sensor. ● Even when set to "ON", AUTO OPEN/CLOSE (LID) is not performed for about 15 seconds after the toilet seat or toilet lid is closed. <ul style="list-style-type: none"> • When the toilet lid is closed by hand (To make the NEOREST more user-friendly, a time interval is set from when the lid is closed to when it will open next.) → Leave the bathroom, and then after 15 seconds or more, approach the bowl unit. 	44 11 22
	<ul style="list-style-type: none"> ● Is "AUTO OPEN WAITING TIME" set to 30s or 90s? 	44
	<ul style="list-style-type: none"> ● Is a toilet seat or lid cover installed? → Remove any covers. 	11
The toilet lid does not close automatically	<ul style="list-style-type: none"> ● Is "AUTO OPEN/CLOSE (LID)" set to "OFF"? → Set to "ON". ● When you do not sit on the toilet seat, or when the time spent sitting on the toilet seat or standing in front of it is 6 seconds or less, the toilet seat and toilet lid close after about 5 minutes. ● If they do not close automatically even though "AUTO OPEN/CLOSE (LID)" is set to "ON", the body sensor may be detecting incorrectly. → If there is a reflective object in front, such as a mirror or glass, move the reflective object or use a curtain or other object to block it. 	44 22 11
	<ul style="list-style-type: none"> ● Is the sensor directly exposed to sunlight? → Do not directly expose the sensor to sunlight, because it may cause incorrect detection. ● Is there a heater within the detection range of the body sensor? → Do not place within the detection range of the sensor. ● Is a urinal or wash basin also installed in the bathroom? → The sensor may detect someone using the urinal, causing the toilet lid to open or close. 	11
The toilet lid closes on its own	<ul style="list-style-type: none"> ● Is "AUTO OPEN/CLOSE (LID)" set to "ON"? ● Is AUTO CLOSE WAITING TIME set to 25s? ● The seat switch may have difficulty detecting some sitting postures. → Sit back on the toilet seat. 	44 11
The toilet lid and toilet seat open at the same time	<ul style="list-style-type: none"> ● Are the settings configured to open the toilet lid and toilet seat at the same time? 	44
Stops (or closes) while opening	<ul style="list-style-type: none"> ● If the lid or seat hits an obstruction the first time it opens after inserting the power plug, it may stop (or close) partway during the next operation. → While there are no obstructions, disconnect the plug and insert it again after about 5 seconds. Then press the "OPEN/CLOSE (Seat)" button on the remote control. ● If the lid or seat hits an obstruction the first time it opens after switching ON the breaker on the distribution board, it may stop (or close) partway during the next operation. (UK) → Eliminate any obstructions and switch the breaker on the distribution board to OFF. Switch it to ON again after about 5 seconds. Then press the "OPEN/CLOSE (Seat)" button on the remote control. (UK) 	-
	Cannot open or close with the remote control	<ul style="list-style-type: none"> ● If it opens automatically → Check "Is the remote control working?" ● Incorrect detection may occur when operating under fluorescent lights.

Troubleshooting

Toilet Seat and Toilet Lid		
Trouble	Please check	Ref. Page
The toilet seat does not get warm	● Is the toilet seat temperature set to "OFF" or a low level? →Set to "ON".	24
	● Is the ENERGY SAVER LED (green) lit? • Timer energy saver is operating and has turned off the toilet seat heater. →When you sit on the seat, the heater is turned on temporarily and the seat is warmed in about 15 minutes.	26
	● Is the ENERGY SAVER LED (orange) lit? • The toilet seat temperature has been lowered to save energy (The auto energy saver in operation). →When you sit on the seat, the heater is turned on temporarily and the seat is warmed in about 15 minutes.	
	● Have you been seated for a long time? • After about 20 minutes of sitting, the temperature starts going down, and after about 1 hour, the heater is turned "OFF". →Move away from the toilet seat and then go back.	-
	● The seat switch may have difficulty detecting some sitting postures. →Sit back on the toilet seat.	11
● Is a toilet lid or seat cover installed? →Remove any covers.	11	

Energy Saver		
Trouble	Please check	Ref. Page
The timer energy-saver feature is not working	● Did you replace the remote control batteries? • When the batteries are discharged, the settings may be erased. →Reconfigure the setting.	14 28
The auto energy-saver feature is not working	● Because the function takes several days learning the usage conditions before starting energy saver, the amount of energy saving may be low, depending on the frequency of use. →Check the type of energy saver.	26

Deodorizer		
Trouble	Please check	Ref. Page
The deodorizer seems to be not working	● Even after sitting down, you do not hear operation sounds. →Sit back on the toilet seat.	11
	● If you hear an operation sound when you sit on the toilet seat. →Clean the deodorizing filter.	33
A strange odor is emitted	● Are you using an air freshener or deodorizer that you purchased separately? • Doing so may reduce the effectiveness of the NEOREST deodorizer or cause strange odors. →Remove the air freshener or deodorizer.	-
The deodorizer is not working	● Is "DEODORIZER" set to "OFF"? →Set to "ON".	46

Sanitary		
Trouble	Please check	Ref. Page
The soft light or bowl light does not light up	● Is the setting "OFF"? →Set to "ON".	48
Pre-mist / after-mist is weak	● Is the mist nozzle clogged? →Perform Descaling mode.	34
	● Is the water filter drain valve clogged with any dust? →Clean the filter.	39
Pre-mist / after-mist is not sprayed	● The following functions do not work when the toilet seat is open. ● Is "Seat/lid" of "Auto open/close" set to "Seat-lid"? →You can change it to "Lid".	- 44
	● The pre-mist is not sprayed for about 90 seconds after the after-mist has finished.	-
	● Is the mist nozzle clogged? →Perform Descaling mode.	34
	● Is the water filter drain valve clogged with any dust? →Clean the filter.	39
The mist sprays out spontaneously	● When body sensor A detects someone, the pre-mist is sprayed.	11
	● When the cleansing functions have not been used in 8 hours, mist is sprayed inside the bowl unit automatically.	20
The UV lamp illuminates the inside of the toilet bowl. (TCF996 only)	● When the cleansing functions have not been used in 10 hours, the UV lamp lights up.	20
The CLEAN indicator does not light up	● Is the setting "OFF"? →Set to "ON".	48
	● If the CLEAN indicator does not light up, it is time for parts replacement. Consult with us (See the contact information on the back cover).	Back cover
The toilet bowl surface repels water or tends to get dirty (TCF996 only)	● The toilet bowl surface needs to be cleaned. →Clean with a toilet brush or the like using commercially available hydrochloric acid-based or inorganic acid-based detergent. • For daily cleaning, use neutral detergent.	32
	● Is "AUTO OPEN/CLOSE (LID)" set to "OFF"? →When AUTO OPEN/CLOSE is set to "OFF", UV light does not work while the lid is open.	44

Others		
Trouble	Please check	Ref. Page
Water is leaking from the plumbing connections	● If any nuts in a connection are loose, firmly tighten them with a tool such as a monkey wrench. →If the water leak does not stop, close the shutoff valve and seek repair.	-
The display on the remote control goes out	● The display goes out when no button on the remote control is pressed for 1 minute or more.	14 17

Troubleshooting

Others		
Trouble	Please check	Ref. Page
The top unit is unstable	<ul style="list-style-type: none"> There is clearance between the toilet seat cushion and the bowl unit for activating the seat switch. When you sit on the toilet seat, the toilet seat subsides slightly to activate the seat switch. 	11
The top unit makes a sound	<p><When moving away from the bowl unit after use></p> <ul style="list-style-type: none"> You may hear the sound of the remaining water being drained. <p><When not using the product></p> <ul style="list-style-type: none"> When the cleaning feature is not used for about 8 hours, you may hear the sound of auto wand cleaning. 	- 20
Water splashes up when using the toilet	<ul style="list-style-type: none"> The water in the bowl unit that is used to mask the smell of excrement is the cause of the splashing. → Adding a layer of toilet paper on the surface of the water can slightly dampen splashing. 	-
When cleansing, you hear a squishing sound underneath the floor	<ul style="list-style-type: none"> Flush the toilet and check for sounds coming from the discharge pipe. Use a device that maintains the necessary toilet water level. 	-
When flushing, you hear a gurgling sound	<ul style="list-style-type: none"> When the toilet is flushed together with waste material, the sound is a result of air, waste material and water being pulled through the system. 	-
There is a black stain on or around the bowl unit	<ul style="list-style-type: none"> Ammonia in urine may cause black stains. → If urine has splashed on the bowl unit or floor, wipe it immediately. 	-
There is black or pink slime on the toilet bowl surface	<ul style="list-style-type: none"> It is a result of growth of airborne fungal spores or bacteria that feed on filth on the toilet bowl. → Clean with (non-abrasive) neutral toilet detergent. 	-
There are water droplets on the bowl unit surface	<ul style="list-style-type: none"> Condensation occurs when the humidity is high, and there is a significant difference between water and room temperatures. → Wipe off droplets with dry cloth. (May also occur on condensation-proof bowls when the difference between room and water temperatures exceeds 15°C and the ambient humidity reaches 80%.) 	-
[POWER] (blue) and [ENERGY SAVER] (orange) LEDs on product main body are blinking	<ul style="list-style-type: none"> If the [POWER] (blue) and [ENERGY SAVER] (orange) LEDs blink at the same time, it is time to perform Descaling mode. → Please perform Descaling mode. 	34

Specifications

Item		TCF996	TCF994	
Rated power supply		AC 220 - 240V, 50Hz		
Rated power consumption		844 - 854W		
Maximum power consumption		1527 W (When the water supply temperature is 0 °C))		
Type		Instantaneous		
Power cord length		1.0m		
Water protection level		IPX4		
Bowl unit	Flush volume ^{*1}	Flush: 6.0L, Light flush: 3.0L		
	Water supply system	Concealed tank system		
Flush type		Cyclone flushing (Washdown type)		
Functions	Cleansing	Spray volume	Rear cleansing	Approx. 0.27L to 0.43L/min.
			Rear soft cleansing	Approx. 0.27L to 0.43L/min.
			Front cleansing	Approx. 0.29L to 0.43L/min.
		Water temperature	Adjustable temperature range: OFF, about 30°C to 40°C	
	Heater capacity	1200 - 1428W		
	Safety device	Temperature fuse		
	Backflow prevention device	Vacuum breaker, Air gap according to EN1717		
	Warm air dryer	Warm air temperature ^{*2}	Adjustable temperature range : About 35°C to 55°C	
		Airflow volume	Approx. 0.29m ³ /min.	
		Heater capacity	200 - 238W	
Safety device		Temperature fuse		
Heated seat	Surface temperature	Adjustable temperature range: OFF, about 28°C to 36°C (About 26°C when auto energy saver is in operation)		
	Heater capacity	55 - 65W		
	Safety device	Temperature fuse		
Deodorizer	Method	O ₂ deodorizing		
	Airflow volume	Approx. 0.16 m ³ /min.		
	Power consumption	Approx. 5.3W		
Water supply pressure		Minimum required water pressure: 0.1MPa (dynamic), Maximum required water pressure: 1.0MPa (static)		
Water supply temperature		0°C to 35°C		
Working ambient temperature		0°C to 40°C		
Dimensions		W 423mm x D 675mm x H 529mm		
Weight		About 44kg (Top unit: about 11kg, bowl unit: about 33kg)	About 43kg (Top unit: about 10kg, bowl unit: about 33kg)	

*1 Volume when used in combination with the dedicated concealed tank.

*2 Temperature around the warm air outlet measured by TOTO.

● When disposing of this product, please follow your local or state guidelines for proper disposal.

Warranty

LIMITED TWO YEARS WARRANTY

1. TOTO warrants its products to be free from manufacturing defects under normal use and service for a period of two(2) years from the date of purchase. This warranty is extended only to the ORIGINAL PURCHASER.
2. TOTO's obligations under this warranty are limited to repair or replacement, at TOTO's option, of products or parts found to be defective, provided that such products were properly installed and used in accordance with this OWNER'S MANUAL. TOTO reserves the right to make such inspections as may be necessary to determine the cause of the defect. TOTO will not charge for labour or parts in connection with warranty repairs or replacements.
TOTO is not responsible for the cost of removal, return and/or reinstallation of products.
3. This warranty does not apply to the following items:
 - a) Damage or loss sustained in a natural calamity such as fire, earthquake, flood, thunder, electrical storm, etc.
 - b) Damage or loss resulting from any unreasonable use, misuse, abuse, negligence, or improper maintenance of the product.
 - c) Damage or loss resulting from removal, improper repair, or modification of the product.
 - d) Damage or loss resulting from sediments or foreign matter contained in a water system.
 - e) Damage or loss resulting from the quality of water in the region where the product is used.
 - f) Damage or loss resulting from improper installation or from installation of a unit in a harsh and/or hazardous environment.
4. This warranty gives you specific legal rights. You may have other rights which vary from country to country.
5. To obtain warranty repair service under this warranty, you must take the product or deliver it prepaid to a TOTO service facility, together with a letter stating the problem, or contact a TOTO distributor or product service contractor, or directly to a TOTO sales office. If, because of the size of the product or nature of the defect, the product cannot be returned to TOTO, receipt by TOTO of a written notice of the defect shall constitute delivery. In such case, TOTO may choose to repair the product at the purchaser's location or pay to transport the product to a service facility.

This written warranty is the only warranty made by TOTO. Repair or replacement as provided under this warranty shall be the exclusive remedy available to the purchaser. TOTO shall not be responsible for loss of use of the product or for other incidental, special, or consequential damage or expenses incurred by the purchaser, or for labour or other costs due to installation or removal, or costs of repairs by others, or for any other expense not specifically stated above. Except to the extent prohibited by applicable law, any implied warranties, including that of merchantability or fitness for use, are expressly limited to the duration of this warranty. Some nations do not allow limitations on how long an implied warranty lasts, or the exclusion or limitation of incidental or consequential damage, so the above limitation and exclusion may not apply to you.

Important User Guidance Information



If you want to dispose this product, do not mix it with general household waste. There is a separate collection system for used electronic products in accordance with legislation that requires proper treatment, recovery and recycling.

Private households in the member states of the EU, Switzerland and Norway may return their used electronic products free of charge to designated collection facilities or to a retailer (if you purchase a similar new one). For countries not mentioned above, please contact your local authorities for the correct method of disposal. By doing so you will ensure that your disposed product undergoes the necessary treatment, recovery and recycling, which prevent potential negative effects on the environment and human health.

Only discard discharged batteries. They should not be disposed of with household waste, but rather at appropriate collection sites or at the product retailer.

MEMO

MEMO