

Halo Screen Slider
installtion instructions



1700x1500mm

- Please read these instructions in full before installing











IMPORTANT

- Check that the bathtub has been installed to the manufacturer's instructions. Please note - All product is supplied without a bathtub.
- Opening wall adjustments
1700mm - adjustment = 1670 - 1700 mm

GENERAL SAFETY INSTRUCTIONS

- Do not fix the wall profile to newly plastered, painted or papered walls as chemical reaction may cause discolouration to the surface finish.
- Important: The wall plugs included in this pack are for solid walls only. If the product is to be mounted on a partition or stud wall, specialised fixings should be purchased separately.
- Fixing tips; A piece of insulating tape or a couple of layers of masking tape applied to the wall before marking out the fixing holes will help stop the drill from wandering, particularly on tiled surfaces.
- When working near a basin or bath insert the plug into the waste, this will help you avoid losing small parts. Also take care not to drop accessories or tools onto the bath or basin, use a towel or bathmat to protect delicate surfaces.
- **CAUTION!**
Before drilling into any walls check that there are no hidden cables or pipes. Exercise great care when using power tools near water. The use of a residual current device (RCD) or cordless drill is recommended. Always double check the positioning and measurements before drilling holes.
- This product is heavy and requires two people during lifting and operations.
- Glass is delicate, support on cardboard to minimise risk of damage.

Tools required (not supplied)

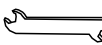
Electric drill		tape measure	
drill(Ø3.2mm)		rubber hammer	
drill(Ø6mm)		knife	
cross tip screw driver		pencil	
spirit level		silicone sealant	
wrench		spanner	

IDENTIFICATION OF PARTS

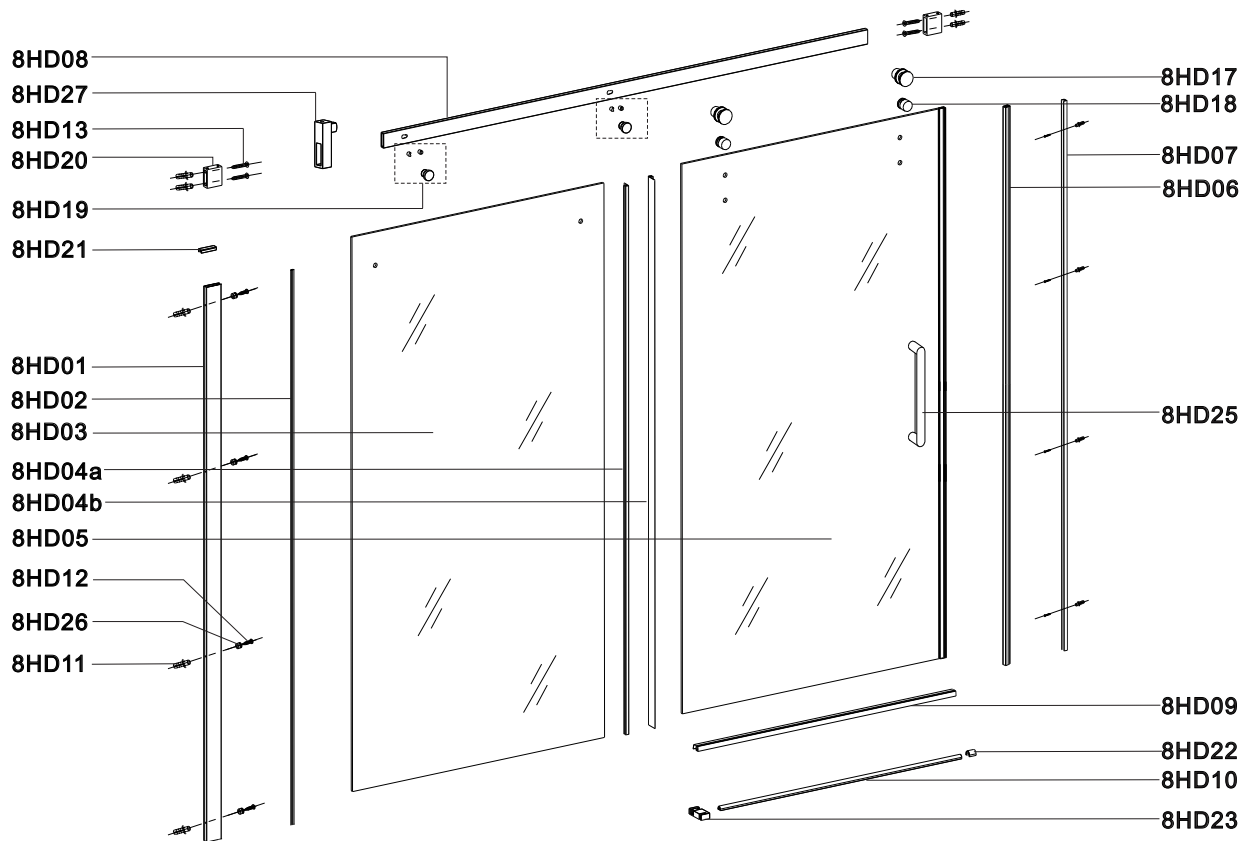

Fixings & fittings supplied

Item No.:	Part	Quantity	Item No.:	Part	Quantity
8HD01		X 1	8HD15		X 1
8HD02		X 1	8HD16		X 1
8HD03		X 1	8HD17		X 2
8HD04		X 2	8HD18		X 2
8HD05		X 1	8HD19		X 2
8HD06		X 1	8HD20		X 2
8HD07		X 1	8HD21		X 1
8HD08		X 1	8HD22		X 1
8HD09		X 1	8HD23		X 1
8HD10		X 1	8HD24		X 1
8HD11		X 12	8HD25		X 1
8HD12		X 8	8HD26		X 4
8HD13		X 4	8HD27		X 1
8HD14		X 2			

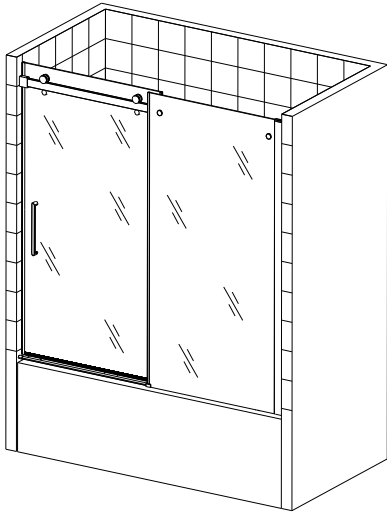

LH

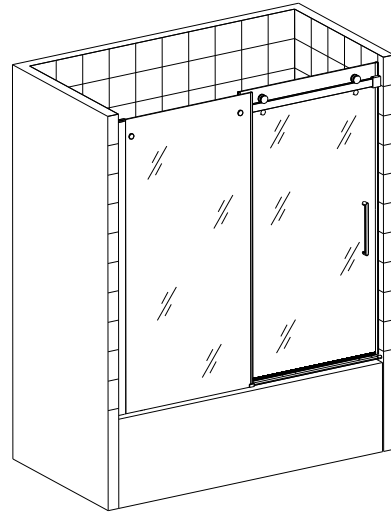

RH



Halo screen is reversible for Left hand and Right hand. But the mounting instruction is the same for both directions. Below step is followed by left hand. For right hand, please follow below steps in mirror direction.

1. Measure the wall with spirit level to make sure the wall is vertical.
2. Put the wall profiles 8HD01 against the wall, ensuring the distance between the profile and the bath edge is correct. Adjust the profile to make sure it is vertical by using a spirit level. Mark the holes on the wall.
3. At the right side of the wall profile, mark the holes position of the rail profile seat by using tool 8HD15.
4. Drill the holes ($\varnothing 6$ mm) according to the marks and insert the wall plugs 8HD11(6X) into the holes.
5. Apply silicone down the whole length on the back of wall profile 8HD01 before fixing wall profile on the wall with screw 8HD12(4X) and the screw washer 8HD26(4X).
6. Fix rail profile seat 8HD20 on the wall with screw 8HD13(2X).

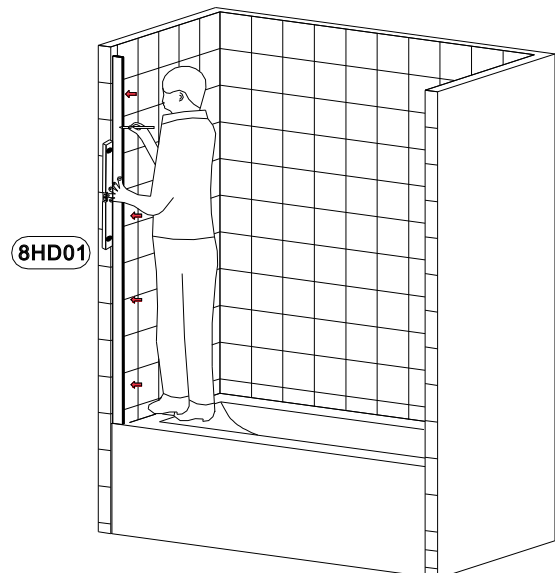
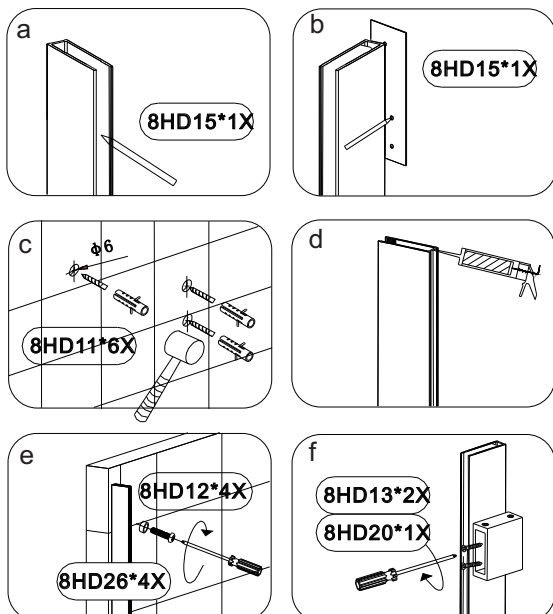
8HD01		X 1
8HD15		X 1
8HD11		X 6
8HD12	ST4X40	X 4
8HD13	ST4X40	X 2
8HD20		X 1
8HD26		X 4



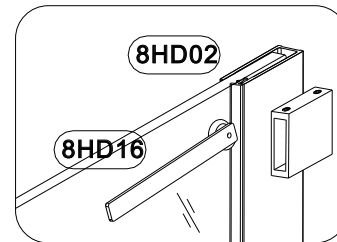
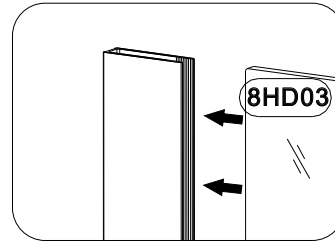
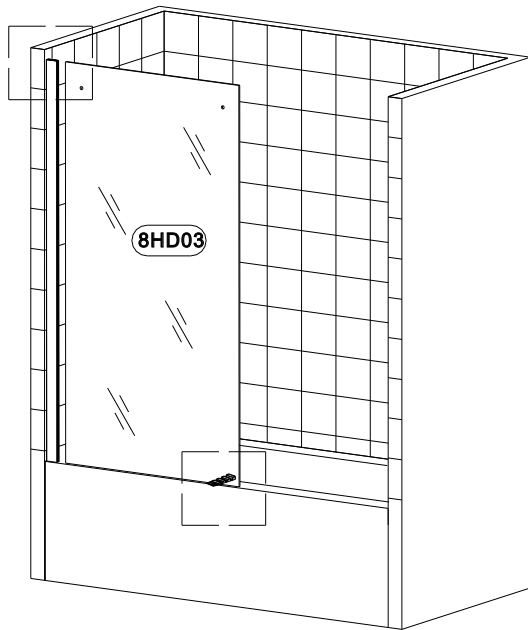

- 2.**
1. Insert fixed glass panel 8HD03 into the wall profile.
 2. Then insert single blade sealer 8HD02 from the inside of cabin between wall profile and glass panel with tool 8HD16.

8HD03		X 1
8HD02		X 1
8HD16		X 1



- 3.**
1. Disassemble stopper 8HD27 to part A, B, C and D with hex key 8HD24.
 2. Insert rail profile 8HD08 into part A.
 3. Fix part A on rail profile with screw C.
 4. Insert B into A and fix them with D.

8HD27		X 1
8HD08		X 1
8HD24		X 1

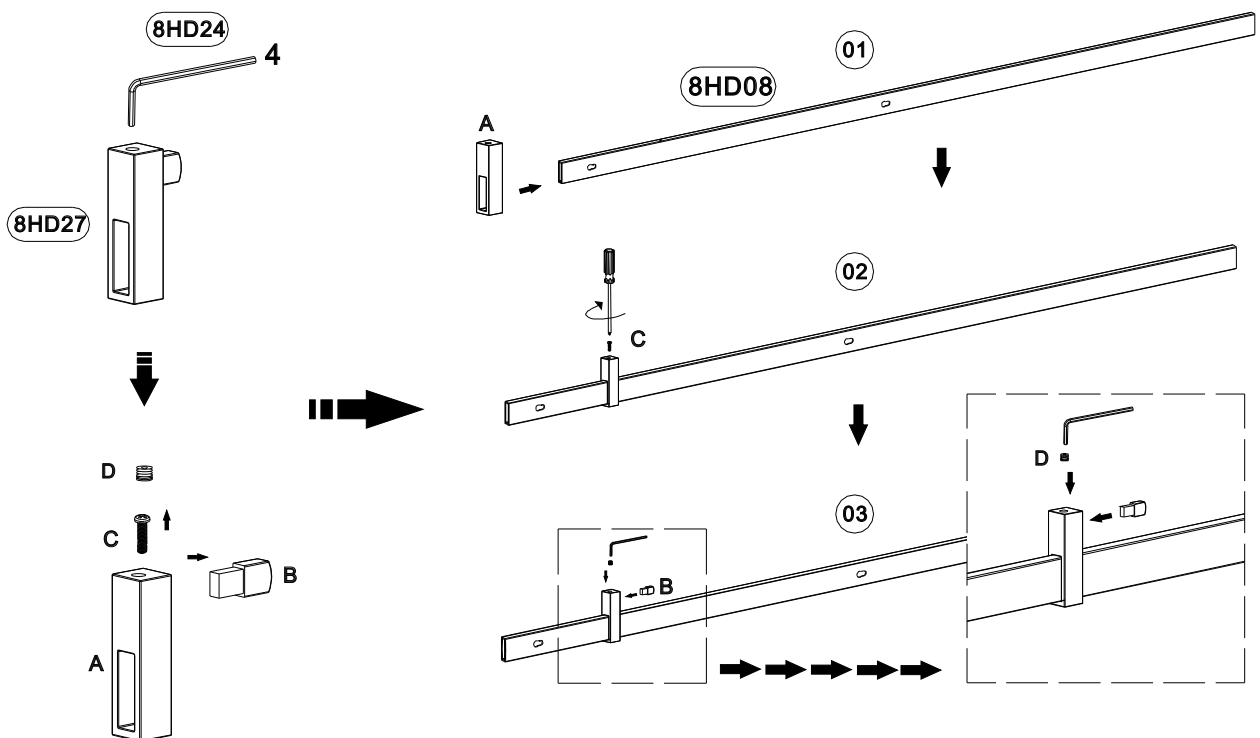

- 4.**
1. Loose the back nut E of 8HD19 to disassemble 8HD19 to part E, F and G. Insert back nut E into the holes on the rail profile.
 2. Peel off the skin of paper on the F. Insert F also into the hole to fix nut E tightly on the rail profile.
 3. Disassemble wall bracket 8HD20 to part H and I with hex key 8HD24.
 4. Put part H on the other end of rail profile 8HD08.

8HD19		X 2
8HD24		X 1
8HD20		X 1

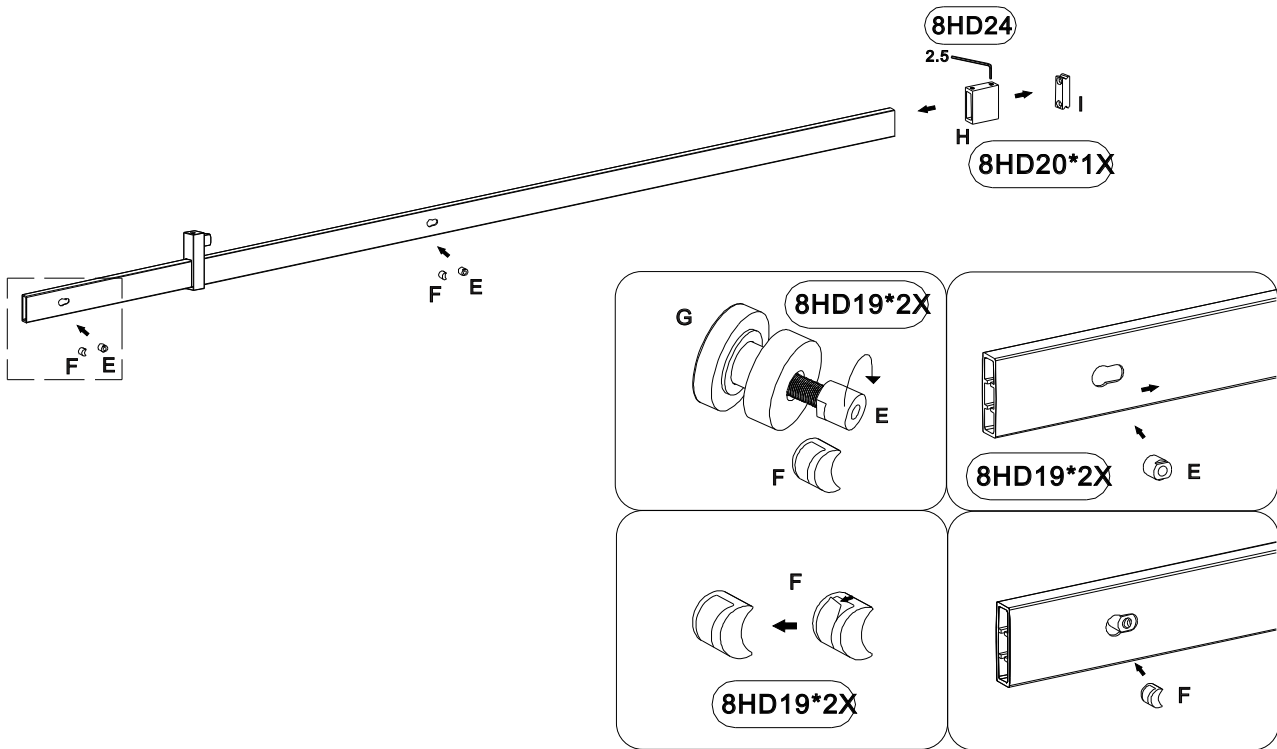

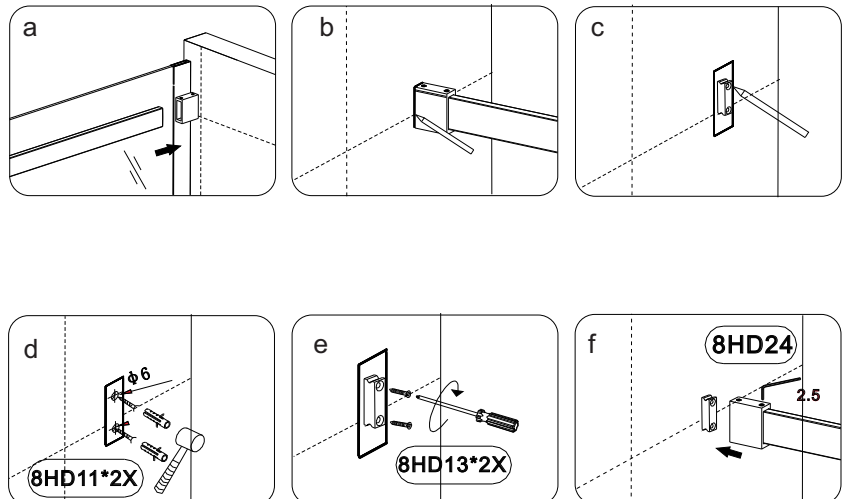
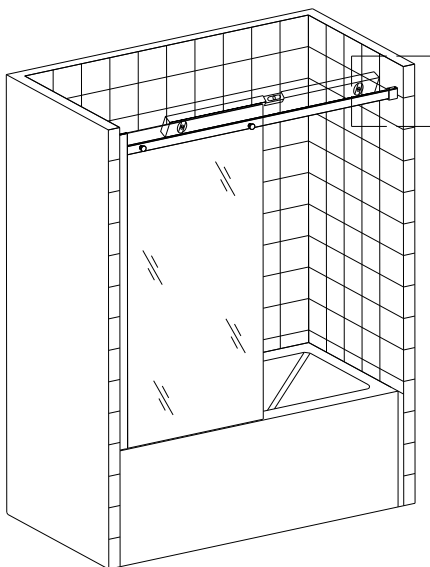

- 5.**
1. Insert the rail profile into wall bracket of fixed glass panel side.
 2. Measure the rail profile with spirit level to make sure the rail profile is horizontal. Match the holes on rail profile and fix glass panel.
 3. Mark the position of 8HD20 accordingly.
 4. Drill the holes (ϕ 6mm) according to the marks and insert the wall plugs 8HD11(2X) into the holes.
 5. Fix the seat I on the wall with screw 8HD13(2X) and fasten the wall bracket H with seat I by hex key.

8HD11		X 2
8HD13		X 2
8HD24		X 1



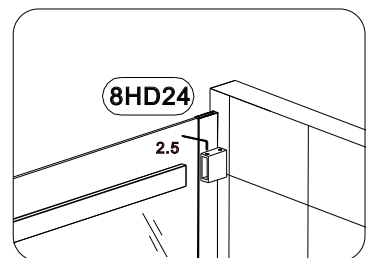
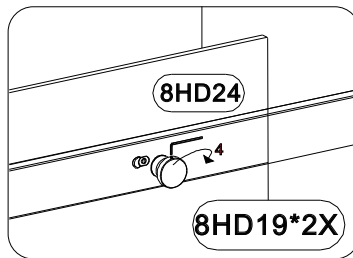
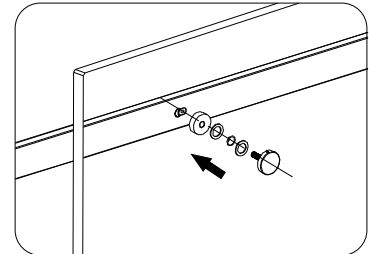
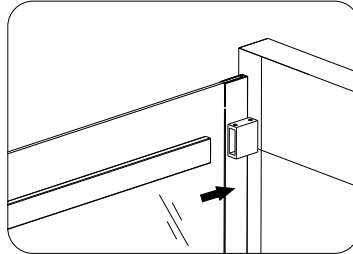
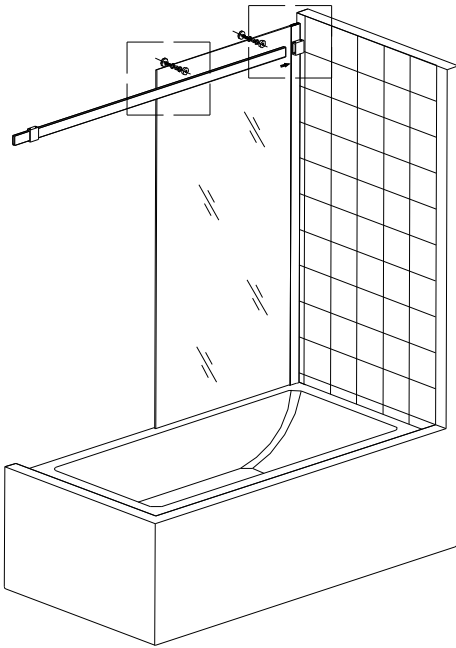

- 6.**
1. Insert the rail profile into wall bracket next to fixed glass panel again.
 2. Put fixing part H of 8HD19(2X) through the holes of the glass panel to reach rail profile. Fasten 8HD19 by hex key.
 3. Fix the rail profile and the wall bracket with hex key for both ends.

8HD19	H 	X 2
8HD24	 4  2.5	X 1



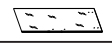

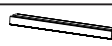
- 7.**
1. Mount rollers 8HD17(2X) on the sliding glass panel 8HD05.
 2. Mount handle 8HD25 on the sliding glass panel.
 3. Apply anti-water sealer 8HD09 on bottom of the sliding glass panel.

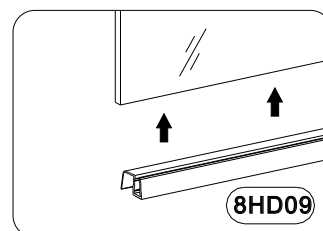
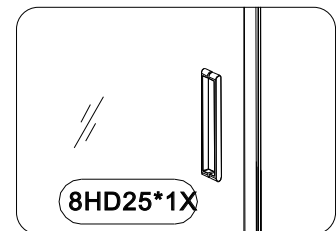
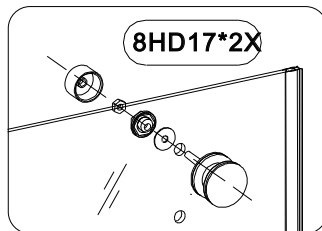
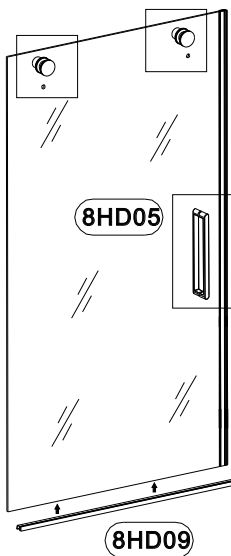
8HD05		X 1
8HD17		X 2
8HD25		X 1
8HD09		X 1



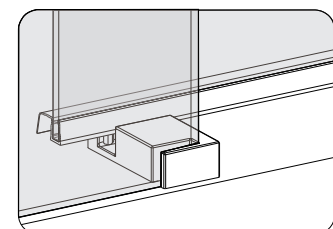
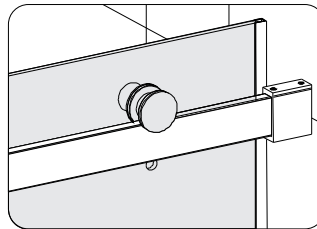
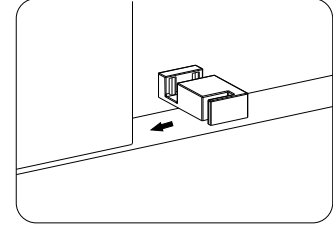
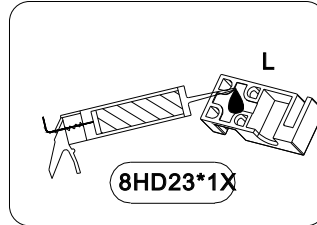
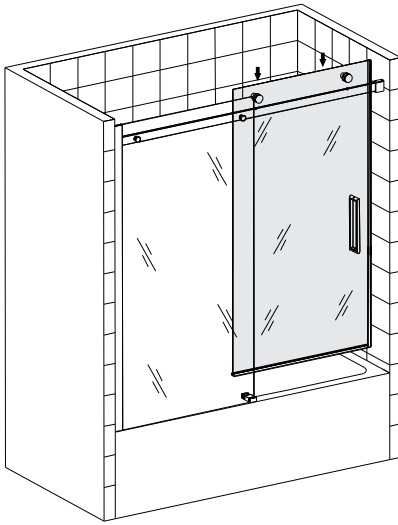

- 8**
1. Apply silicone on the back of sliding guide 8HD23.
 2. Put it right next to the fixed glass panel.
 3. Put the sliding glass panel on the rail profile to make sure bottom edge on the channel of sliding guide.

8HD23	L  R 	X 1
-------	---	-----



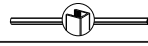

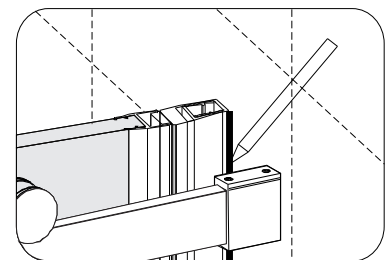
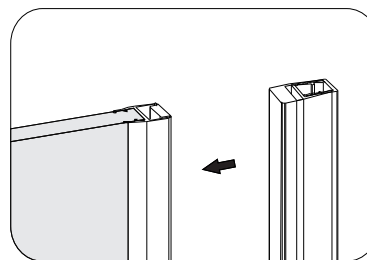
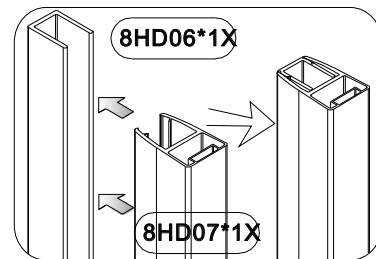
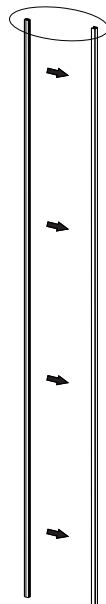
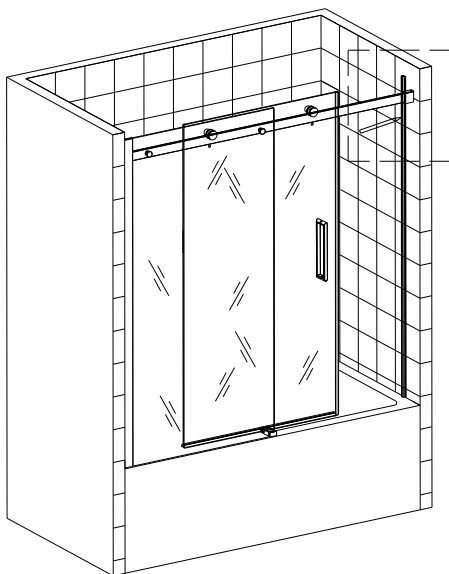

- 9**
1. Insert the small wall profile 8HD06 into magnetic sealer 8HD07.
 2. Adsorb the two strip onto the sliding panel and close the door to the wall and mark the position of the small profile.

8HD06		X 1
8HD07		X 1



10



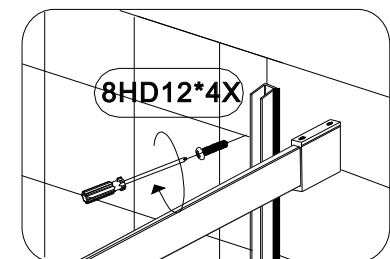
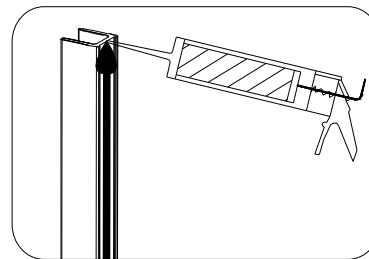
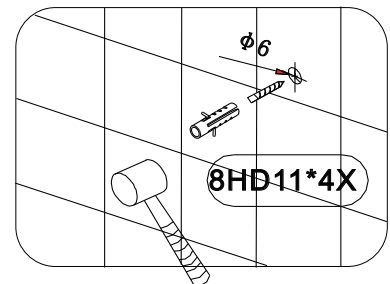
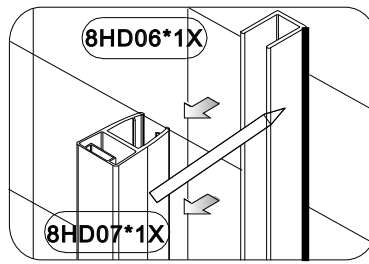
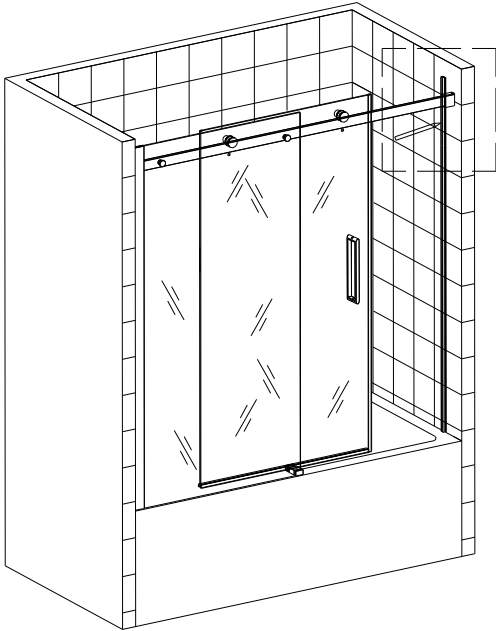

1. Separate the small wall profile 8HD06 and magnetic seal 8HS077.
2. Put small wall profile 8HD067 on the wall against the mark.
3. Mark and drill the holes accordingly.
4. Insert wall plug 8HD11(4X) into the holes.
5. Fix small wall profile 8HD07 on the wall with screws 8HD12(4X).

8HD06		X 1
8HD07		X 1
8HD11		X 4
8HD12	 ST4X40	X 4



11

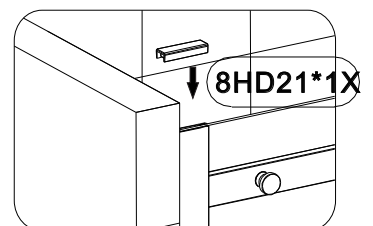
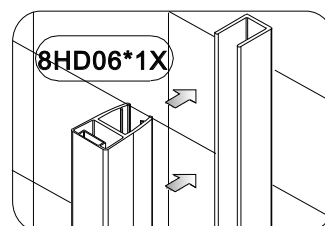
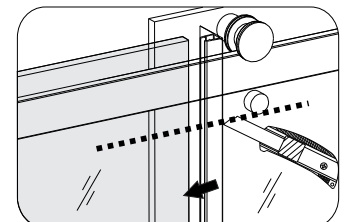
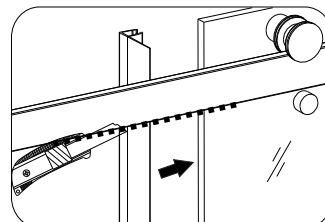
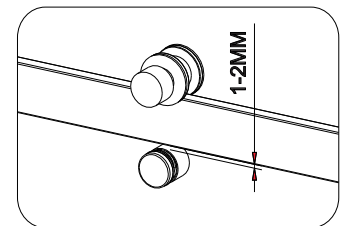
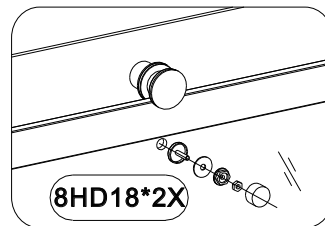
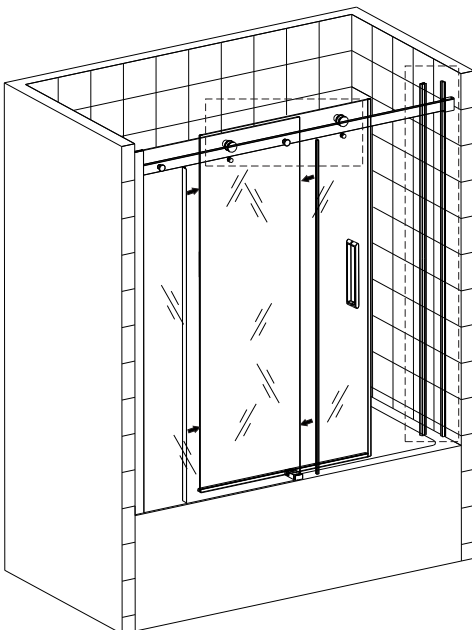

1. Mount anti-jump part 8HD18(2X) on the sliding glass panel to keep distance with 1~2mm to rail profile.
2. Apply vertical seal 8HD04(1X) on the sliding door and cut under the rail profile.
3. Apply vertical seal 8HD04(1X) on the fix panel and cut under the anti-jump stopper.
4. Apply magnetic seal 8HD06 on the small wall profile 8HD07.
5. Put top cap 8HD21 onto the wall profile.

8HD18		X 2
8HD04		X 2
8HD07		X 1
8HD21		X 1



12.

1. Apply silicone on the back of aluminium anti-water strip 8HD10 and strip cover 8HD22.
2. Insert 8HD10 into the hole of sliding guide 8HD23.
3. Put 8HD22 cover on the other end.

8HD10		X 1
8HD22		X 1

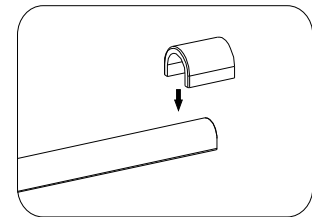
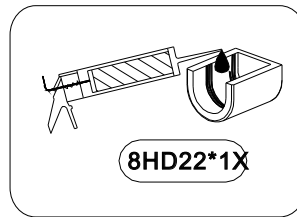
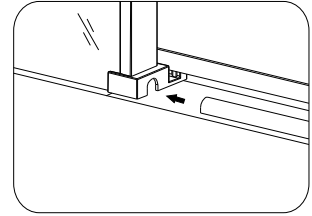
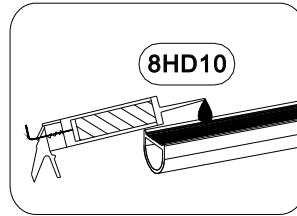
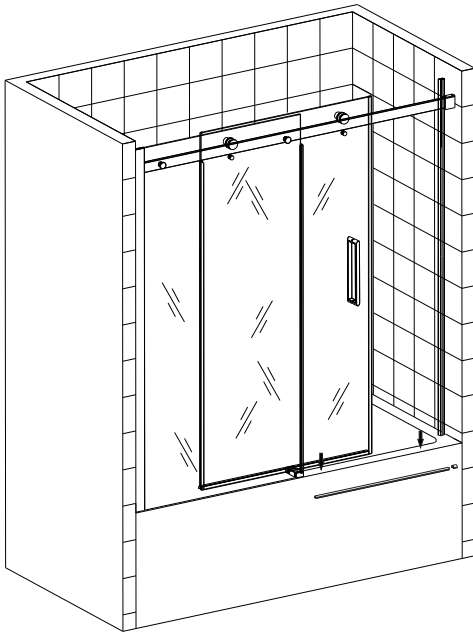

13.

Roller adjustment:

1. From inside of the cabine, take off the back cover from the roller.
2. Turn the nut of the roller with tool 8HD14 until the door is vertical against the magnetic seal well.
3. Fasten both rollers and put the covers back.

8HD14		X 2
-------	---	-----

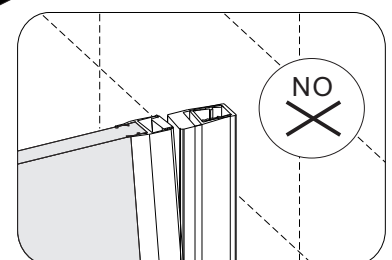
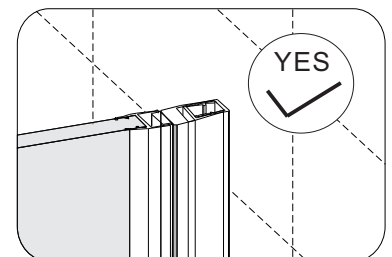
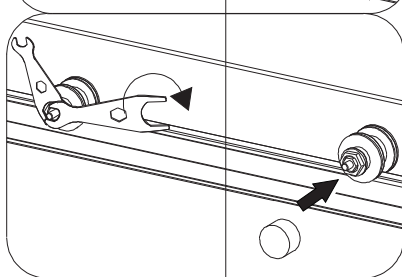
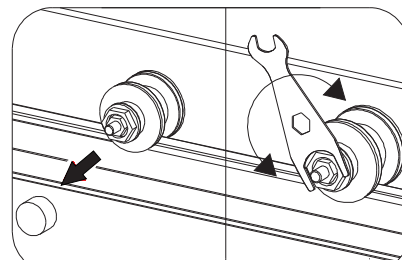
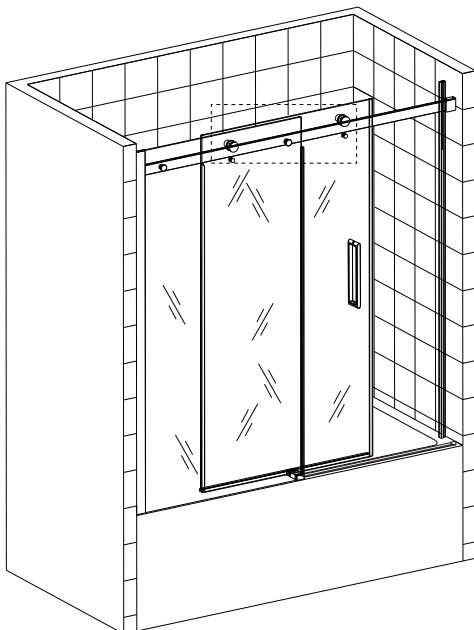

14. Finally, at all points connected to the wall, the bathtub and the profiles, use silicone sealant only on the outside of the shower enclosure. Please do not use showering within 24 hours after silicon sealant.

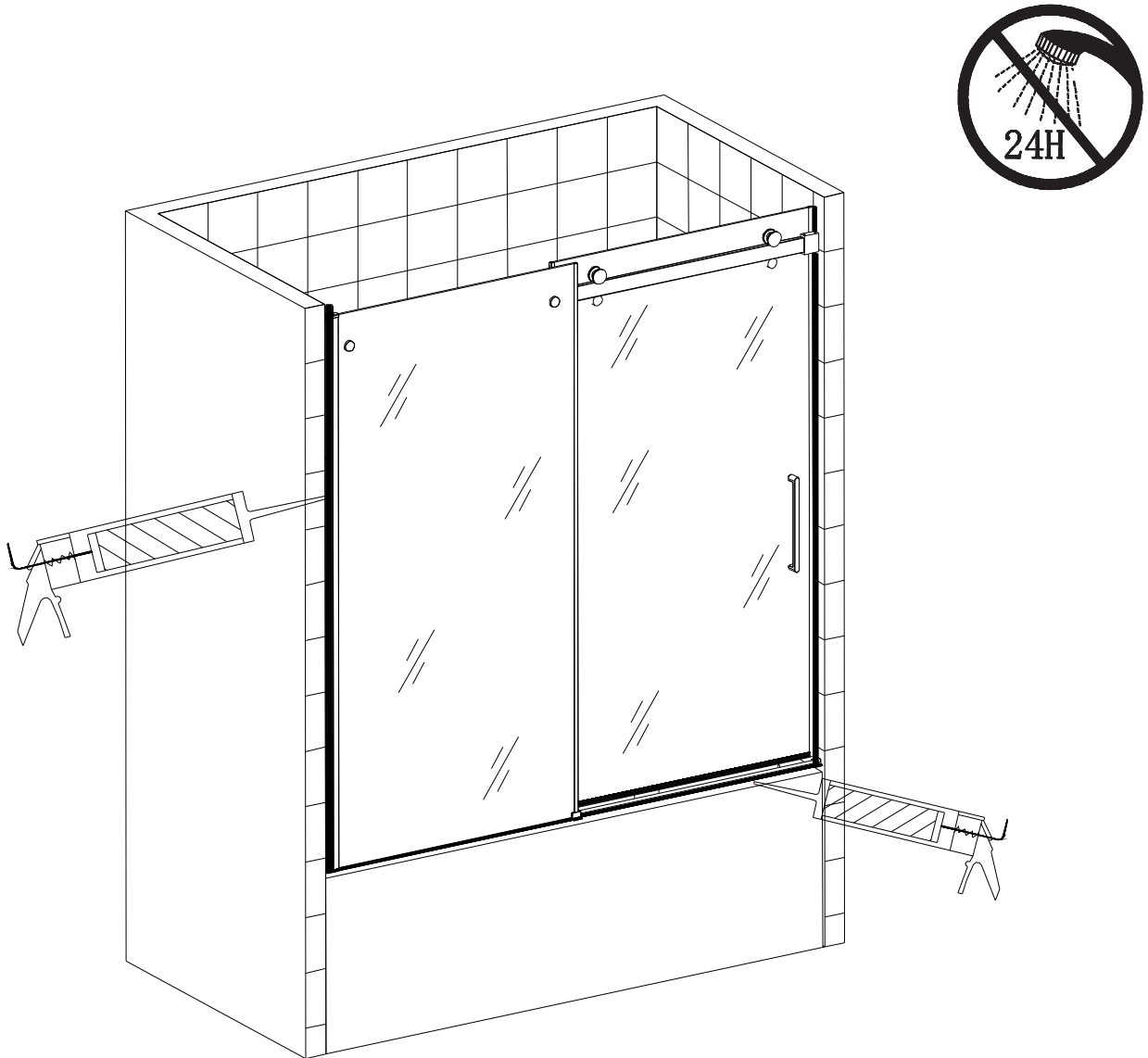

Cleaning and Maintenance:

Please do not use abrasive or strong cleaning solution on the shower enclosure, such as alcohol, petroleum liquids or any other chemical cleaner with acidic contents. Should there be any dirty stains on the shower enclosure, please clean it with a soft lint free cloth and warm soapy water. Please rinse it with clean water afterwards.

After the installation is complete, if there is any noise during glass door movement, please add a small quantity of lubricant onto the roller wheel, bottom guide and track where applicable.

After installation is complete and you are still encountering problems with your enclosure, our sales technicians will be happy to assist.

For information and support: phone 0845 470 24 27