

INSTALLATION INSTRUCTIONS

www.aquadart.co.uk

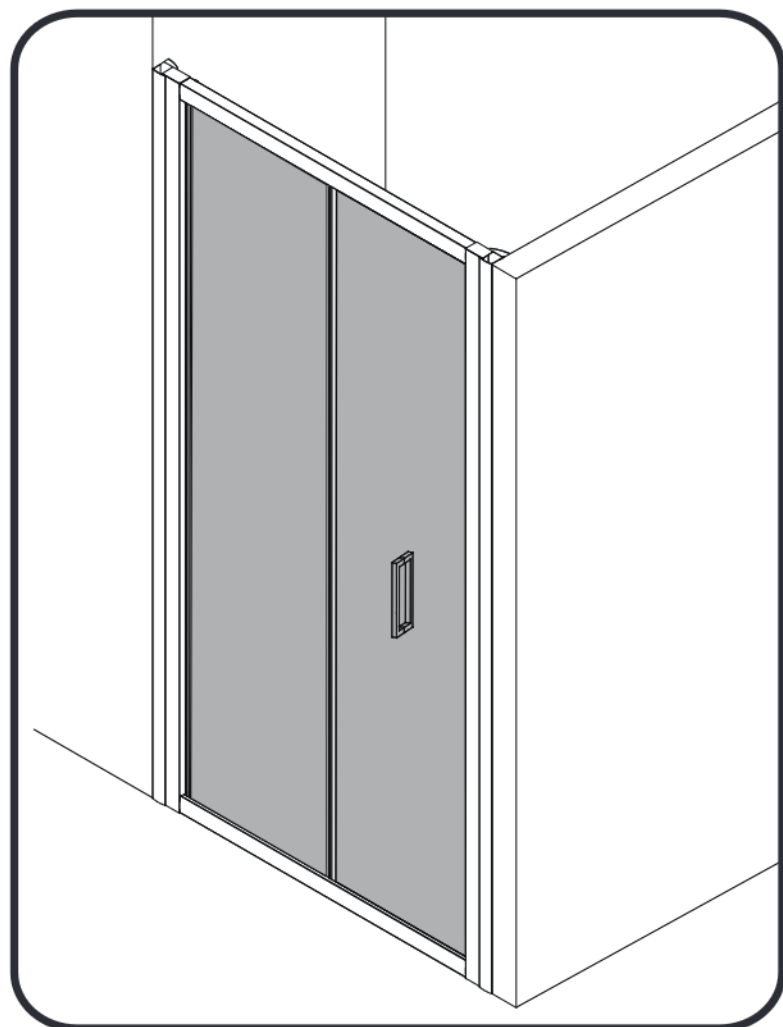

Tools Required



Drill



**6mm Masonry Drill
3.2mm HSS Drill**



Spirit level



**PH2 TYPE
Screwdriver**



Pencil

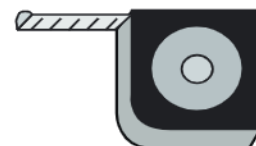

Tape Measure

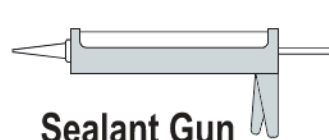

Sealant Gun

Please note hand tools **NOT** supplied.

IMPORTANT

This product should be installed by a suitably qualified and proficient person. The fitting instructions should be followed carefully to ensure a proper and safe installation. Failure to follow these instructions could result in future injury.

These instructions and list of parts assume that installation is done against solid/tiled walls.

Please check this product for damage prior to starting the installation. No claims can be made after the product has been fitted.

PLEASE NOTE :The minimum and maximum adjustment sizes noted on the product brochures are based on perfectly plumb walls and trays.

USE SAFETY EYE-WEAR WHEN DRILLING

COMPONENTS AND BOX CONTENTS

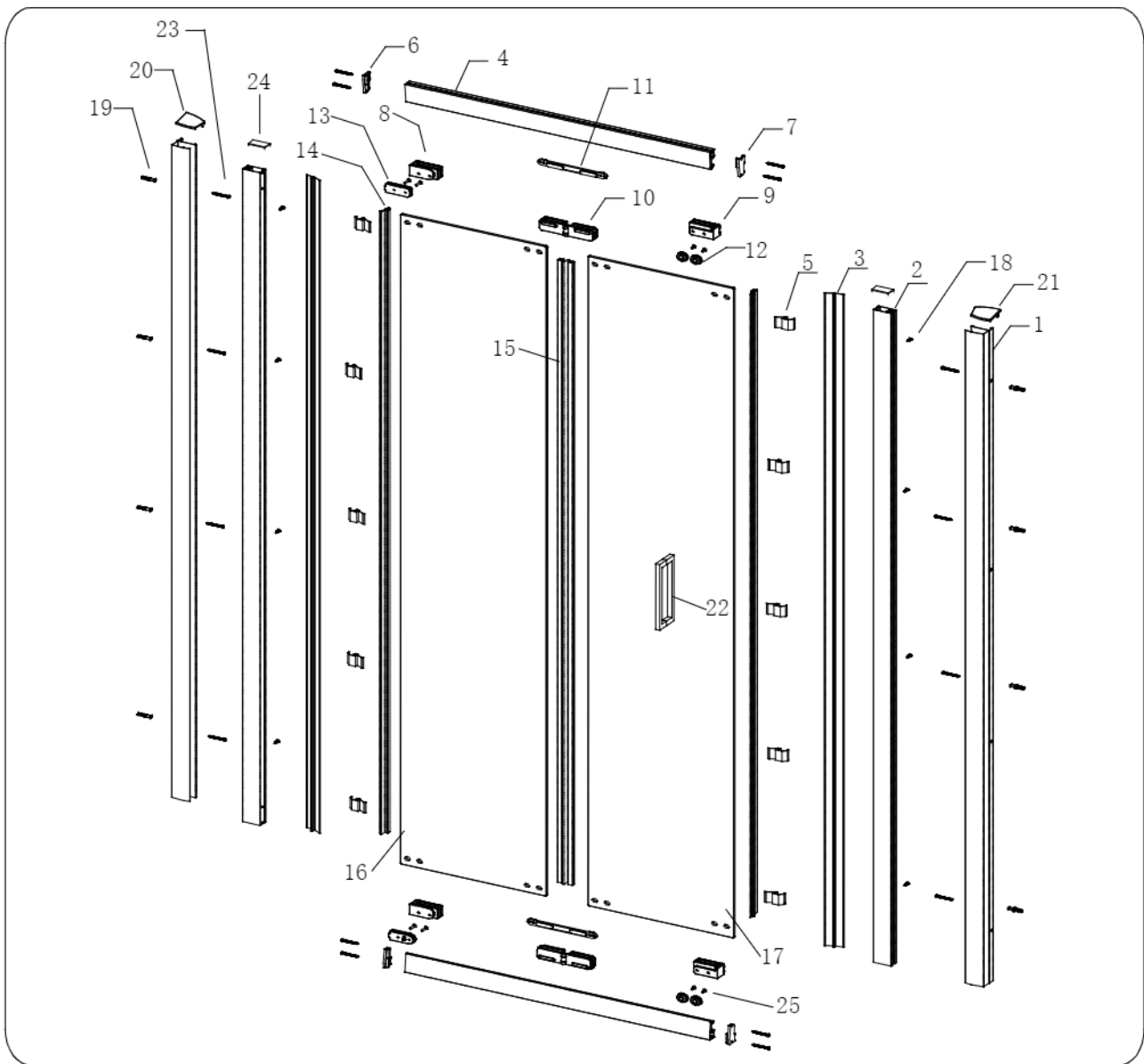

Box Contents

SN	Description	Q'ty	SN	Description	Q'ty
1	Wall profile	2	14	Vertical seal	2
2	Vertical profile	2	15	Connecting seal	1
3	Cover profile	2	16	Fixed glass panel	1
4	Rail profile	2	17	Moving glass panel	1
5	Cover profile clips	10	18	Screw 4x12	8
6	Rail profile end cap-L	2	19	Wall plug	8
7	Rail profile end cap-R	2	20	Wall profile top cap-L	1
8	Bracket-L	2	21	Wall profile top cap-R	1
9	Bracket-R	2	22	Handle	1
10	Hinges	2	23	Screw 4x30	20
11	Magnet block	2	24	Vertical profile top cap	2
12	Wheels	4	25	Screw M5x10	4
13	Stopper block	2	26	Runner stopper	2

FIXING KIT COMPONENTS, SITE CONDITIONS

FIXING KIT

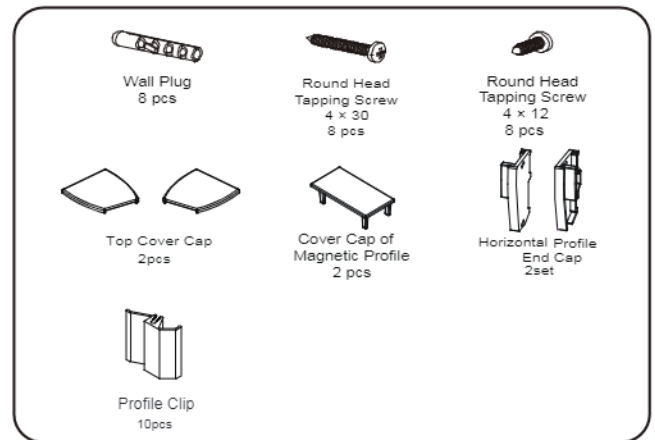
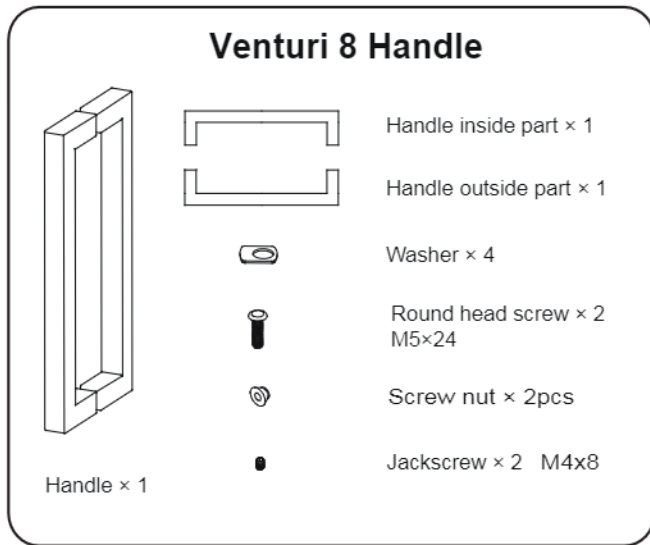

IMPORTANT - Missing Components

Please check this product for missing components prior to installation.

For spare parts visit www.aquadart.co.uk

IMPORTANT - Installation site

1. Ensure the top surface of the shower tray on which the enclosure will be installed is level in every direction.
2. The tiles or other wall finishing should be effectively sealed at tray edges.
3. Tiles should extend at least to the corner of the tray and a minimum of 1.9 meters from the top of the tray.

PROCEDURE

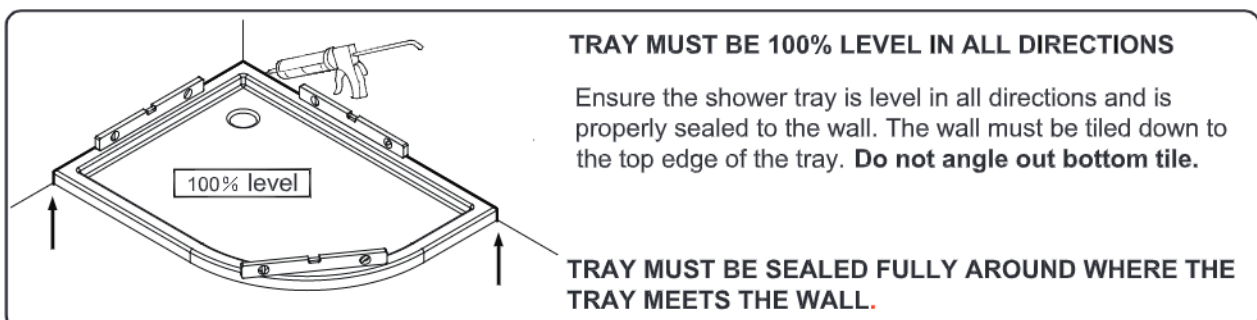

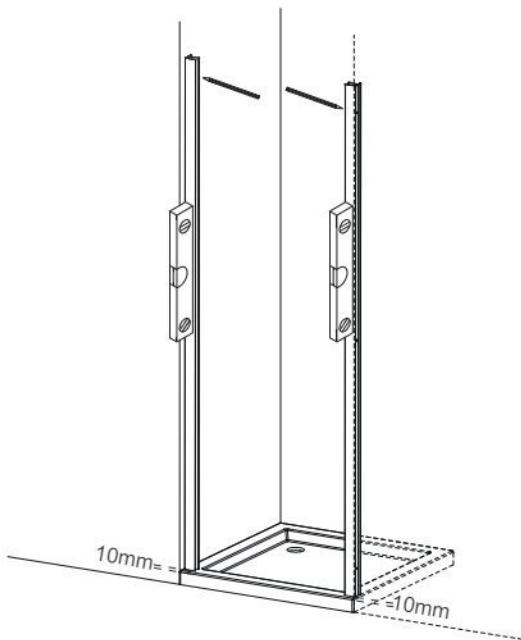

Step 1.1 & 1.2

Step 1.

1.1 Position the wall profiles (**No.1**) to wall as shown (roughly 10mm from the front of the tray).

1.2 Level the frame using a spirit level.

1.3 Once you are happy that the frame sits on the tray correctly mark the wall through the 4 pre-drilled screw holes in the wall profiles.

NOTE: You may find it easier to mark and drill the wall if you apply masking tape to it first.

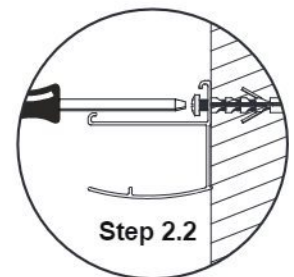
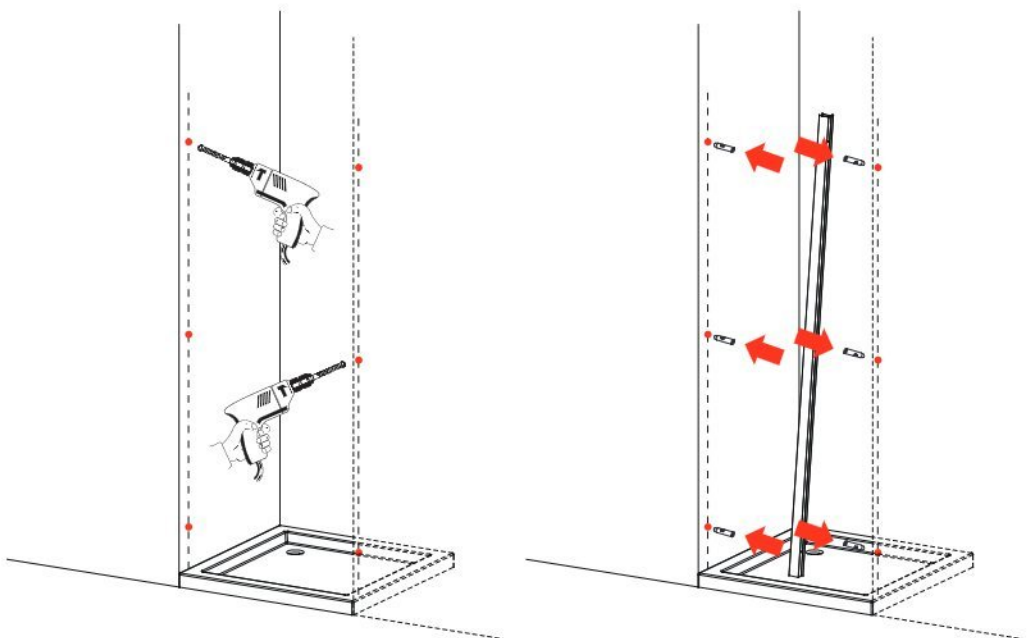

Step 2.1

Step 2.

2.1 Remove the wall profiles and drill the marked points using a 6mm masonry drill bit, once this is done insert 8 × wall plugs (**No.19**).

2.2 Fix the wall profile to wall using the screws ST4 × 30 (**No.20**).

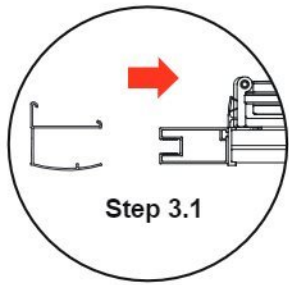

Step 3.1

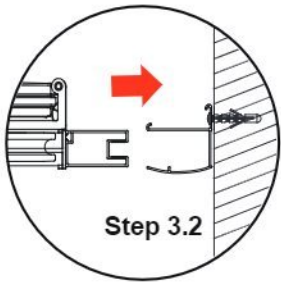

Step 3.2

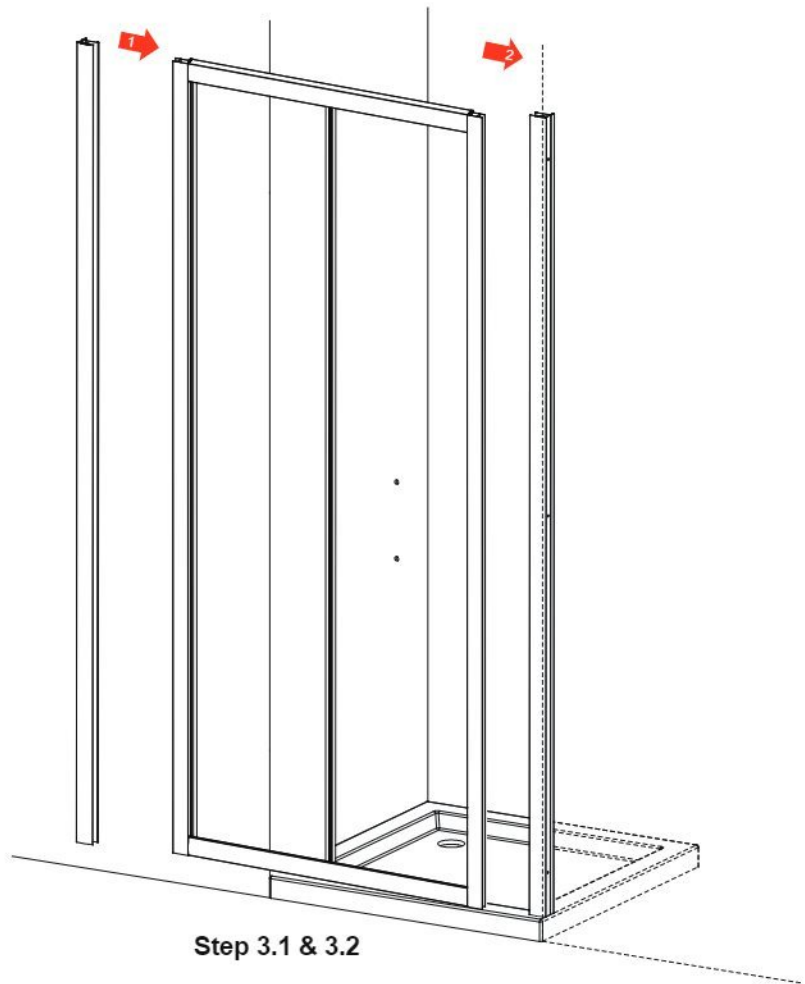

Step 3.1 & 3.2

Step 3.

- 3.1 Push the other wall profile to the frame.
- 3.2 Then insert the frame into the fixed wall profile as shown.

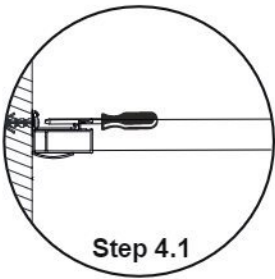

Step 4.1

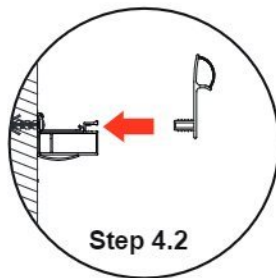

Step 4.2

Step 4.

- 4.1 Fix the other wall profile using screws ST4 × 30.
- 4.2 Press the vertical seal onto the frame profile.

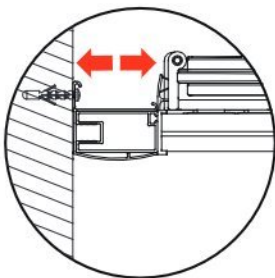

Step 5

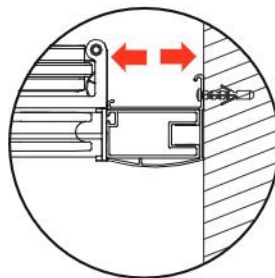

Step 5.

Adjust the frame to ensure that it is central between the wall profiles and level against the shower tray at the base.

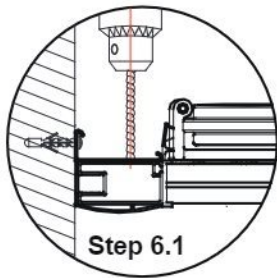

Step 6.1



Step 6.2

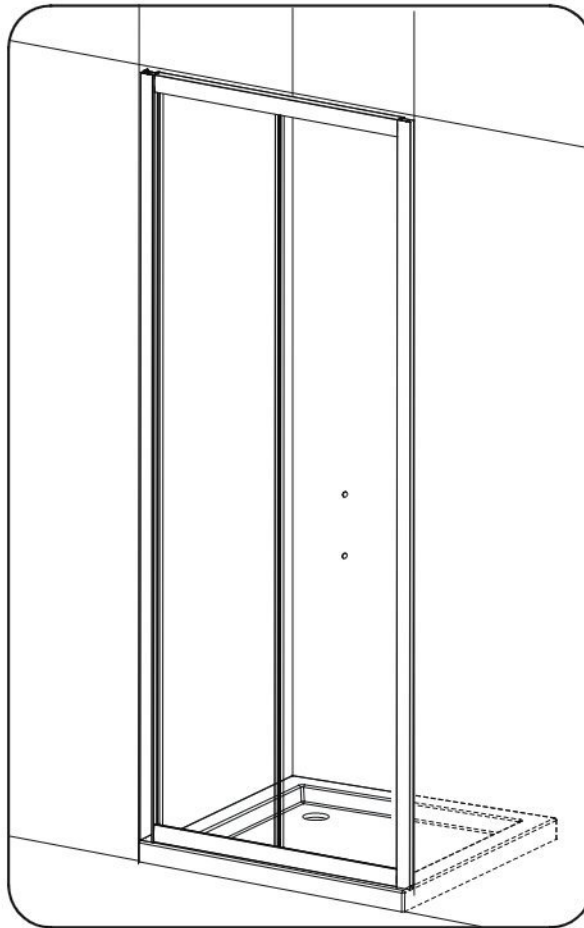

Step 6.

6.1 Drill 4 equally spaced holes with an 3mm drill bit through the wall profiles and frame.

6.2 Fix the frame to the wall profiles using the screws ST 4 × 12.

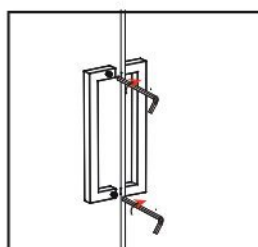
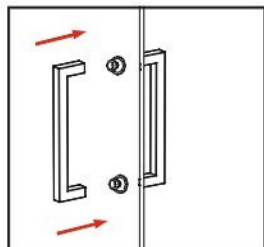
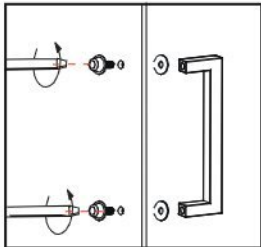

Step 7.

Fix the handle to the door panel as shown on above.

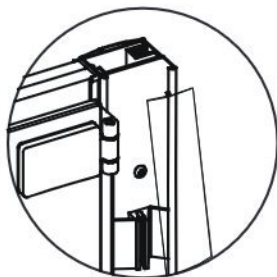

Step 8

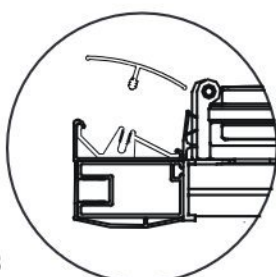

Step 8.

Once you are happy that the installation is correct, push 5 x Profile Clips (No.5) in to the wall profile and evenly space. Push the Cover Profile (No.3) into the Profile Clips as shown.

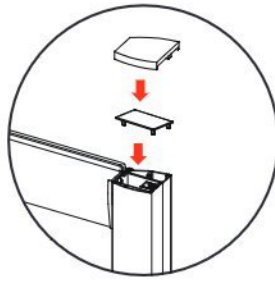
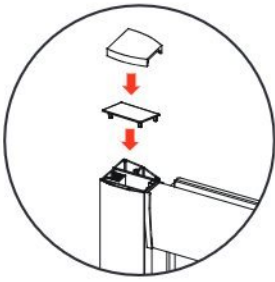

Step 9

Step 9.

Fit the upright profile top caps and wall profiles top caps as shown.

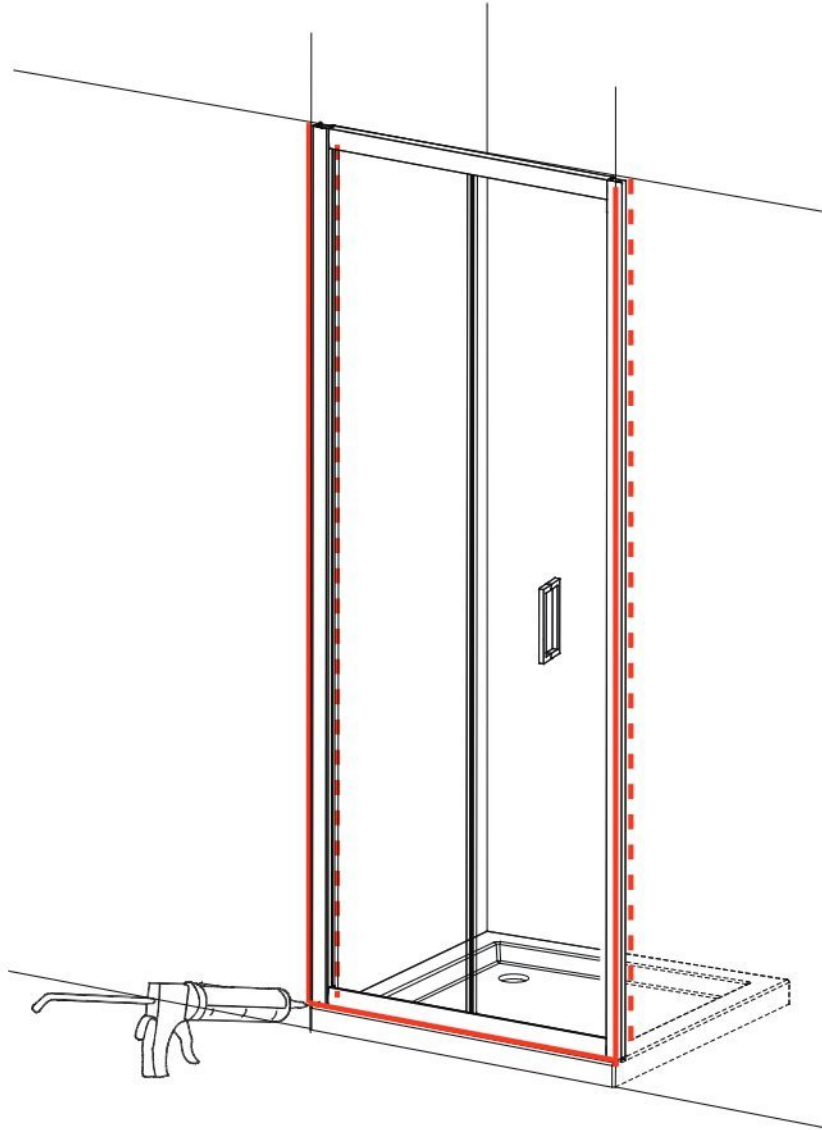

24 HRS

DO NOT USE THE ENCLOSURE FOR 24 HOURS AFTER SEALING

Applying Silicone Sealant

Sealing Inside

Seal from the top of the wall profile to the bottom on the **INSIDE** between the wall profile and the wall.

IMPORTANT: Do not apply sealant on inside of the tray.

Sealing Outside

Seal from the top of the wall profile to the bottom between the wall profile and tiles on both sides. Also seal along the bottom where the frame meets the tray. Seal the joints between the bottom profile and any upright profiles.

AFTERCARE

Cleaning Instructions

It is important to clean your Aquadart shower enclosure after every use. Please wipe down all glass and metal parts with a clean soft cloth. Ensure that all residual water on the glass is removed after every use.

Usage

For reliable, watertight performance from your Aquadart enclosure your shower head should not be positioned so that the shower sprays directly onto the enclosure door. Failure to comply with this may cause the shower to leak. Outward opening doors may cause water to drip onto the floor, please ensure that the floor covering immediately outside the enclosure will not be affected by water.



This product has been treated with Clean & Clear™ easy clean glass treatment, a protective barrier which creates a 'non-stick' surface on your glass, helping to resist lime scale build up and water spots. For further information on Clean & Clear™ please visit www.aquadart.co.uk

Aftercare

Clean & Clear™ glass can be cleaned with any suitable nonabrasive glass cleaner - with PH value of between 3-11; the coating will not be damaged. Avoid surfactants and heavily perfumed products. Vinegar and water based products are very effective. Do not use abrasive scrubbing cleaners or equipment for cleaning.

Warranty

Limited 5 year Warranty for Clean & Clear™ treatment: To guarantee treated surfaces will remain more repellent than untreated glass for 5 years from start of use, as long as basic manufacturer maintenance recommendations are followed and no harsh or abrasive cleaners are used.