

Index

Notes.....	2
Pre-installation	3
Maintenance openings	5
Data sheets for bathtubs and whirltubs	9

Notes

PLANNING

Before starting the installation, plan the layout in detail, taking the site conditions into consideration.

TARGET READERSHIP AND QUALIFICATIONS

All work associated with the installation and water connection may only be undertaken by a plumber and all work associated with the electrical installation may only be undertaken by a licensed electrician.

SAFETY INSTRUCTIONS

Incorrect handling/transport may result in product damage.

The metal frame and whirl system are not resilient.

- > Never hold by the metal frame or whirl system.

Improper transport can cause damage to the product and/or property damage, e.g. leaks.

- > Wear appropriate protective clothing.
- > Avoid knocks.

Risk of product and/or property damage!

The breach of local and country-specific regulations and standards can cause damage to the product and/or property damage.

- > Observe the local installation regulations and any country-specific standards at all times.

Duravit AG assumes no liability for the consequences of improper handling or improper transport.

Pre-installation

INSTALLATION LOCATION / INSTALLATION ROOM

> Make sure that the installation location fulfils the following criteria

Doors / external access	<ul style="list-style-type: none"> Ensure that doors or other access openings are large enough to accommodate transport dimensions, keeping in mind the weight and need for sufficient manoeuvring room.
Required area	<ul style="list-style-type: none"> Allow for enough space around the tub for the installation.
Floor	<ul style="list-style-type: none"> Completely level. At a right angle to the wall. Note the overall strength of the floor structure including the floor finish. There must not be any underfloor heating under the tub. Install tubs after the tiles. (Top edge of finished floor). Depending on the combination of tub and whirl system it is possible that system components may protrude beyond the edge of the tub. We therefore recommend installation in a support frame. Tolerances for acrylic: As a result of the manufacturing process, deviations from the nominal dimensions may occur within the limits specified in the DIN 198 standard. Please take this into account in your planning.
Wall	<ul style="list-style-type: none"> Tiled. At a right angle to the tub. Completely straight. Note the overall strength of the wall structure including the wall finish.

WATER INSTALLATION

NOTE

A pipe interrupter is absolutely essential for tubs with a base inlet (DIN EN 1717).

> Comply with assembly scheme.

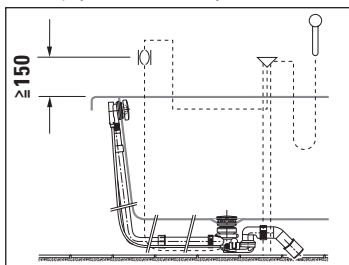

Water connection

- Connections for the water supply and drains must be in compliance with the currently valid standards and public regulations.
- Position the water drain (DN 50) flush to the mounting surface or out of

the wall directly above the mounting surface; see drawing for recommended area.

MAINTENANCE OPENINGS AND AIR SUPPLY

NOTE

It is recommended to install the tub with a removable bathtub panel due to the improved maintenance options.

Tiling the tub

The following maintenance openings must be provided:

- Cable-driven waste and overflow 200 x 200 mm
- Units 500 x 500 mm
(Please see the section on "Maintenance openings")
- Control unit for coloured LED light 200 x 200 mm
(Maintenance opening at the foot end)
- Provide an opening in the panel for the air supply with an effective area of approx. 15cm² (e.g. 3 x 5 cm or 2 x 7.5 cm).

Tub with a panel

- The panel must be removed for maintenance, and with a seamless panel, the tub must be removed from the wall. Your plans should therefore include a clearance in front of the tub.
- The air supply for the whirl system (ventilation grille/ventilation slot) must not be covered.

ELECTRICAL INSTALLATION



DANGER

Risk of fatal electric shock

- Disconnect the power supply while working on the electrical components.
- The device must be earthed. Earthed appliances must be permanently connected to fixed wiring.
- Connect the device only to the designated electrical cable.
- NEVER touch the power supply line with wet hands.

Pre-installation

- Lay a permanent power supply line which must be on a separate circuit.
 - The device itself does not have electrical leakage protection function. The device must be supplied through a residual current device (RCD) with a rated residual operating current not exceeding 30 mA.
 - Means for disconnection must be incorporated in the fixed wiring in accordance with the wiring rules and have a contact separation in all poles that provides full disconnection under overvoltage category III conditions outside the prescribed protection zones (0 – 2).
 - Leave 3000 mm of the supply line exposed.
- Lay an equipotential bonding cable:
 - Leave 3000 mm of cable exposed.
- Select a supply line cross-section based on the connected load on the identification plate (2.5 mm – 4 mm).
- Confirm that the grounding wire is 10 mm (3/8") longer than the L and N wire.
- Install a circuit breaker.

PROTECTION ZONES

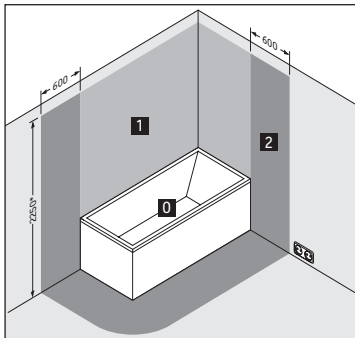

* Or the height of the highest fixed-location shower head/water outlet, whichever is higher.

Combi-System L (# 760XXX XX X CL 10XX)	1.59 kW	2.64 kW
Jet System E (# 760XXX XX X JE 10XX)	1.14 kW	2.20 kW

Power supply

76XXXX XX X XX XXX0: 220 – 240 V AC, 50 Hz

76XXXX XX X XX XXX6: 220 – 240 V AC, 60 Hz

Fuse $I_N = 16 \text{ A}$

RCD $I_{\Delta N} \leq 30 \text{ mA}$

COLOURED LED LIGHT/WHITE LED LIGHT UNDER THE EDGE OF THE TUB FOR BATHTUBS

Electrical data

Power supply

Coloured LED light with remote control for bathtubs #790840 00 0 00 xx00	110 – 240 V AC, 50/60 Hz, 30 W
Coloured LED light with remote control for Blue Moon bathtub #790846 00 0 00 xx00	110 – 240 V AC, 50/60 Hz, 60 W
White LED light under the edge of the tub #791847 00 0 00 0000 #791848 00 0 00 0000 #791849 00 0 00 0000	220 – 240 V AC, 50/60 Hz, 50 W

Fuse $I_N = 16 \text{ A}$

RCD $I_{\Delta N} \leq 30 \text{ mA}$

WHIRLTUBS

Electrical data

Whirl system	Rated power with standard equipment	Max. rated power, fully-equipped
Air System (# 760XXX XX X AS 00XX)	0.76 kW	0.85 kW
Air System (DuraSolid) (# 760XXX XX X AS 00XX)	0.58 kW	0.58 kW
Jet Project (# 760XXX XX X JP 10XX)	0.66 kW	0.66 kW
Jet System (# 760XXX XX X JS 10XX)	0.59 kW	0.67 kW
Combi-System P (# 760XXX XX X CP 10XX)	1.89 kW	1.98 kW
Combi-System E (# 760XXX XX X CE 10XX)	1.91 kW	2.96 kW

Maintenance openings

Maintenance

Install the whirltub in such a way that all of the important equipment (pump, blower and control system) remains accessible. It is recommended to install the tub with a removable furniture panel for easy maintenance.

Location of the whirl system components

The illustrations show the standard configuration for the components of the whirl system* with the location of the operating unit. The back massage is located at the head end (depending on the whirl system).

Custom-made designs available on request. In such cases we will require a drawing showing the desired layout. Duravit will confirm whether the desired layout can be implemented.

Blue Moon

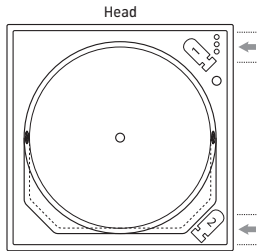

760143

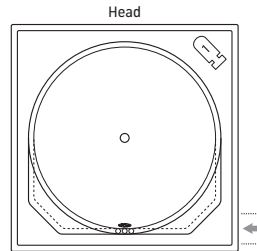

760402

Cape Cod

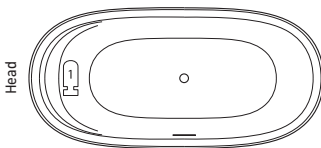

760330

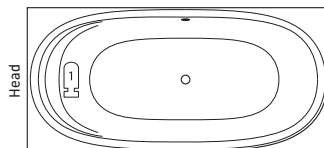

760362

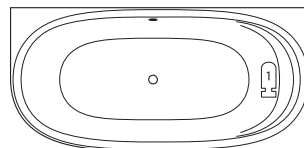

760363

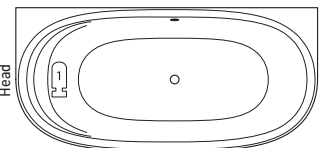

760364

Darling New

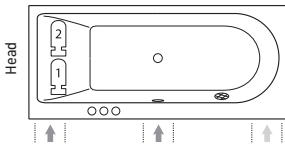

760242

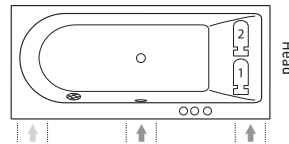

760243

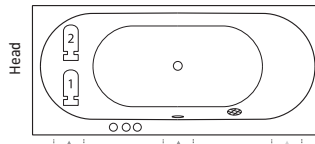

760244, # 760245

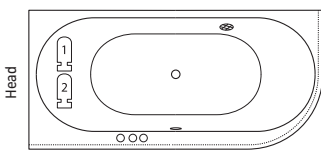

760246

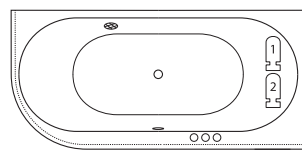

760247

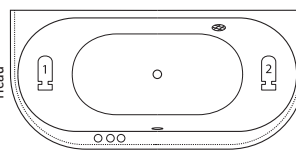

760248

D-Code

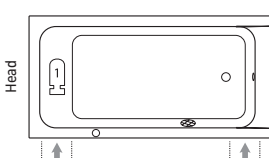

760095, # 760096,
760098, # 760100

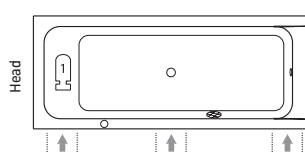

760097, # 760099

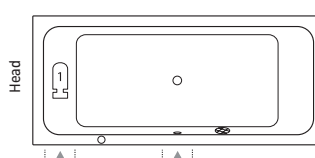

760101

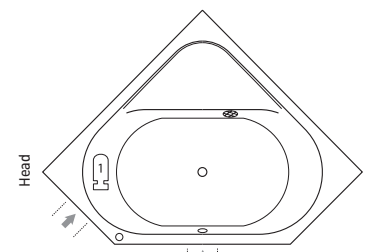

760137

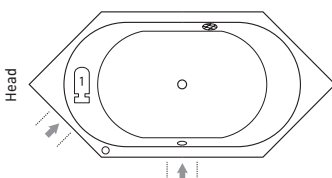

760138

* Please note that depending on the combination of tub and whirl system it is possible that system components may protrude beyond the edge of the tub. We therefore recommend installation in a support frame

DuraSquare

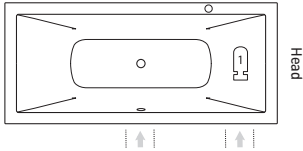

760426

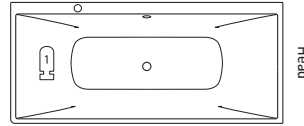

760427

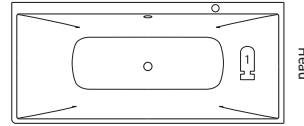

760428, # 760429

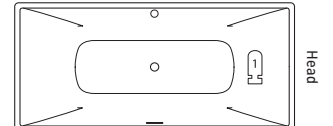

760430

DuraStyle

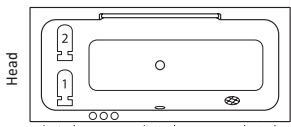

760292, # 760294, # 760296

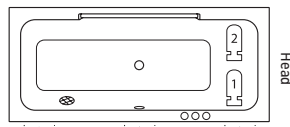

760293, # 760295, # 760297

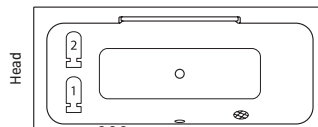

760298, # 760299

Happy D.2

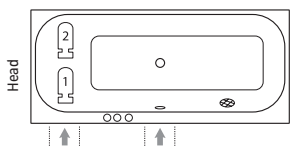

760308, # 760310, # 760312

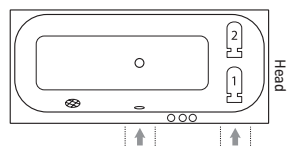

760309, # 760311, # 760313

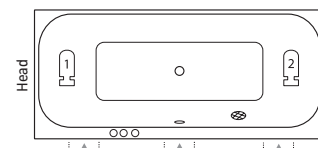

760314, # 760315

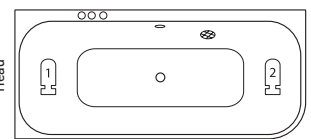

760316

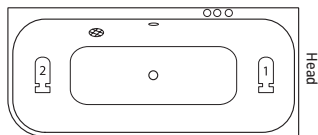

760317

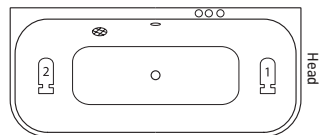

760318

Happy D.2 Plus

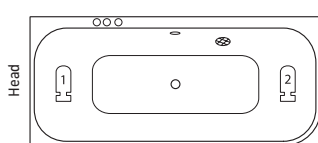

760449

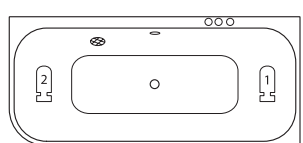

760450

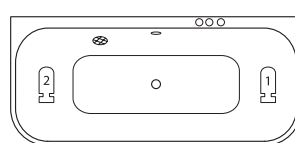

760451

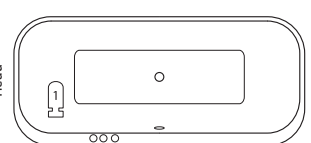

760453

Luv

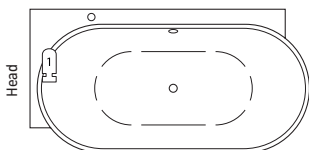

760431

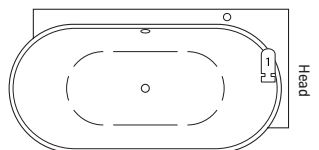

760432

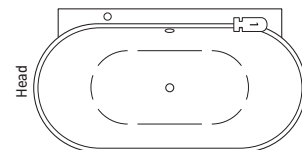

760433

P3 Comforts

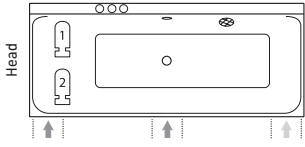

760371, # 760373, # 760375

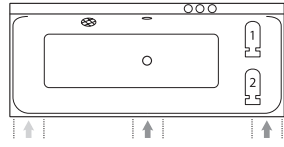

760372, # 760374, # 760376

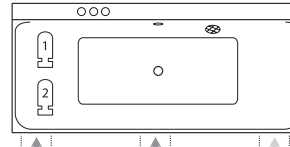

760377, # 760378

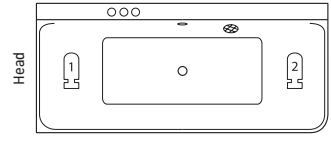

760379

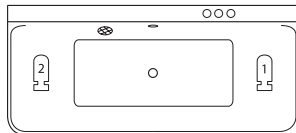

760380

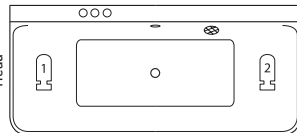

760381

Paiova

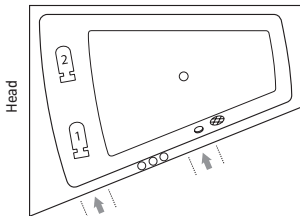

760212, # 760214, # 760216

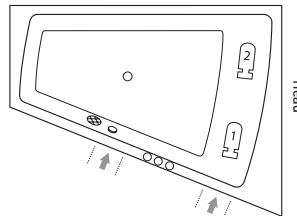

760213, # 760215, # 760217

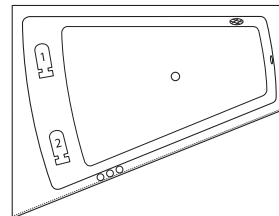

760264, # 760266, # 760268

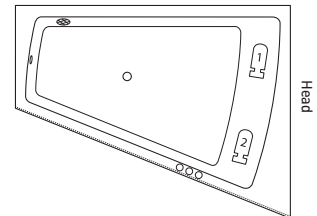

760265, # 760267, # 760269

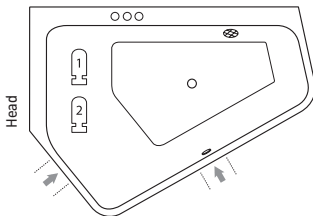

760390, # 760392

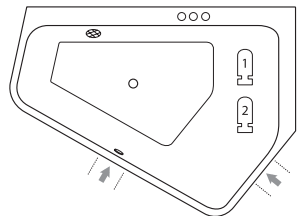

760391, # 760393

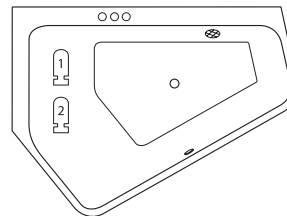

760394, # 760396

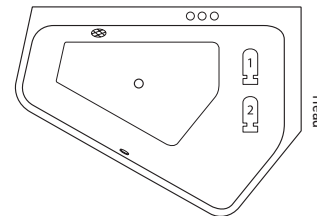

760395, # 760397

Starck

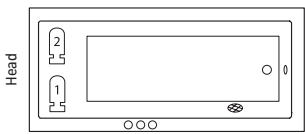

760050, # 760331, # 760332,
760333, # 760334, # 760335,
760336, # 760337

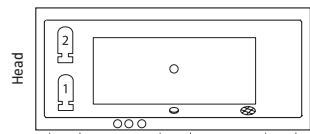

760052, # 760338, # 760339,
760340, # 760341

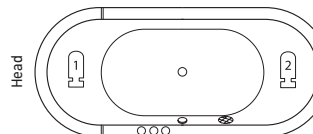

760009

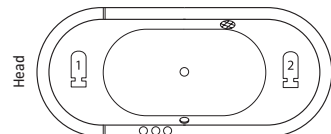

760010

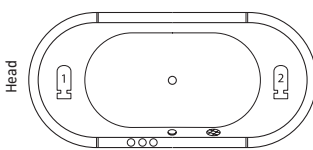

760011

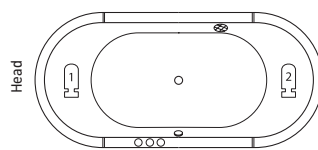

760012

Vero Air

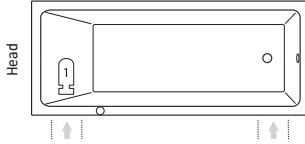

760411, # 760412

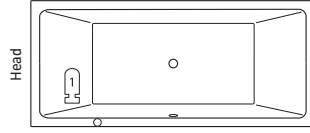

760413, # 760414

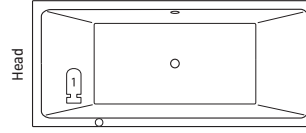

760415, # 760416, # 760417,
760418

Vero

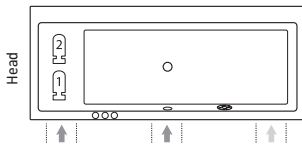

760133

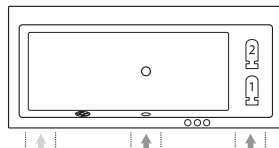

760134

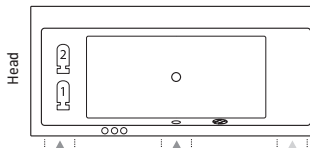

760135, # 760136

Legend



Unit 1



Unit 2*



Control panel**



Suction
screen



Pull
button



Tap module



Recommended
equipment covers



Recommended
equipment covers***

* Only Combi-Systems / ** The number of operating elements is based on the whirl system and the additional modules selected / *** Only necessary for Combi-System E/L in combination with sound and/or coloured LED light

Data sheets for bathtubs and whirltubs

Pre-installation D-Code # 700095/760095

⌋ 1500 x 750 x 400 ⌋

Design by Sieger Design

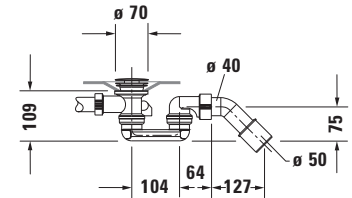
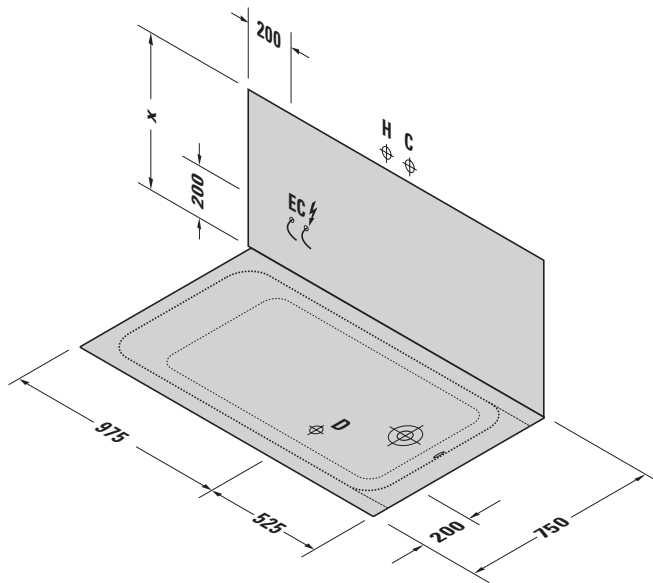

Siphon for bathtub # 700095

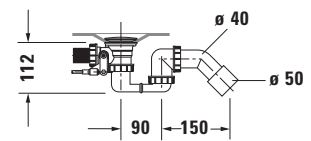

Siphon for whirltub # 760095

- H Hot water connection
- C Cold water connection
- D Drain connection
- EC ⚡ Electricity connection

	Height	including feet	including support	including panel
X Bathtub	420	535 - 600	~ 540	550
X Whirltub	-	540 - 575	-	550

Technical specifications

Net weight kg	Floor load kg/m ²	Shipping weight kg	Shipping dimensions l x w x h (cm)	Water inlet OD, ID	Whirlsystem	Model-No.
17,5	158	32,5	120 x 80 x 165	-		700095 . . . 0 00 0000
26,0	165	56,0	190 x 88 x 75	-	Jet Project	760095 00 0 JP 1000

Pre-installation D-Code # 700096/760096

↳ 1600 x 700 x 400 ‹

Design by Sieger Design

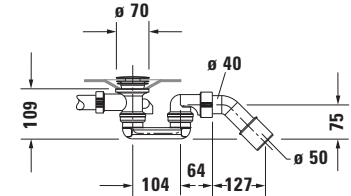
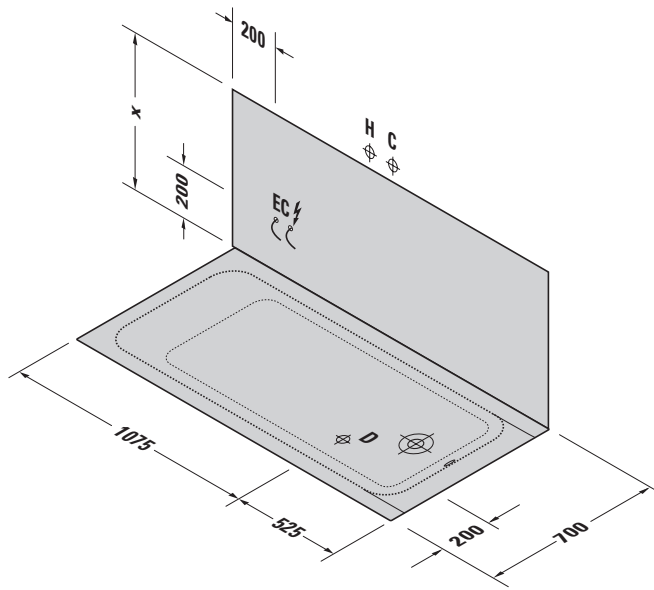

Siphon for bathtub # 700096

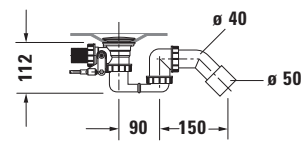

Siphon for whirltub # 760096

- H Hot water connection
- C Cold water connection
- D Drain connection
- EC Electricity connection

	Height	including feet	including support	including panel
X Bathtub	420	535 - 600	~ 535	550
X Whirltub	-	540 - 575	-	550

Technical specifications

Net weight kg	Floor load kg/m ²	Shipping weight kg	Shipping dimensions l x w x h (cm)	Water inlet OD, ID	Whirlsystem	Model-No.
17,5	158	32,5	120 x 80 x 175	-		700096 . . . 0 00 0000
26,0	166	56,0	190 x 88 x 75	-	Jet Project	760096 00 0 JP 1000

Pre-installation D-Code # 700097/760097

⌋ 1700 x 700 x 400 ⌋

Design by Sieger Design

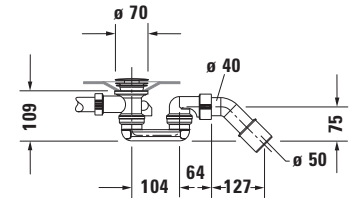
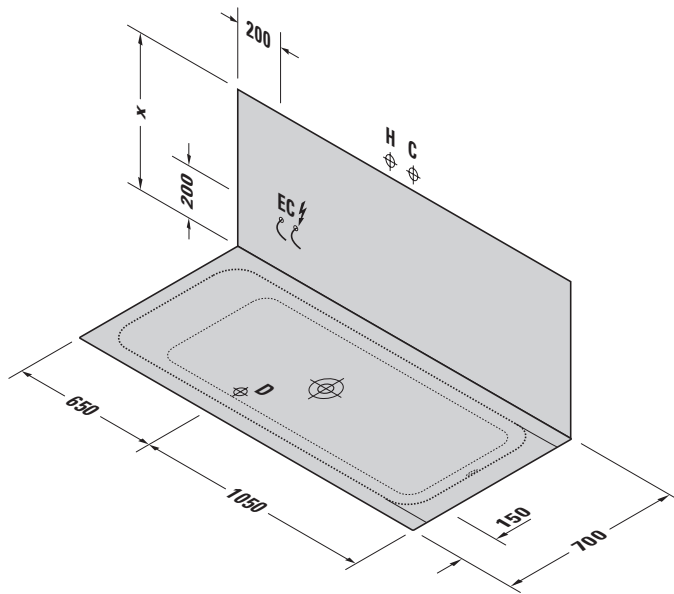

Siphon for bathtub # 700097

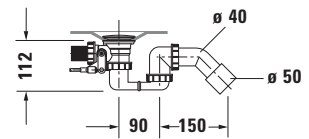

Siphon for whirltub # 760097

- H Hot water connection
- C Cold water connection
- D Drain connection
- EC Electricity connection

	Height	including feet	including support	including panel
X Bathtub	420	535 - 600	~ 540	550
X Whirltub	-	540 - 575	-	550

Technical specifications

Net weight kg	Floor load kg/m ²	Shipping weight kg	Shipping dimensions l x w x h (cm)	Water inlet OD, ID	Whirlsystem	Model-No.
19,5	159	34,5	120 x 80 x 185	-		700097 . . . 0 00 0000
28,0	166	58,0	190 x 88 x 75	-	Jet Project	760097 00 0 JP 1000

Pre-installation D-Code # 700098/760098

↳ 1700 x 700 x 400 ‹

Design by Sieger Design

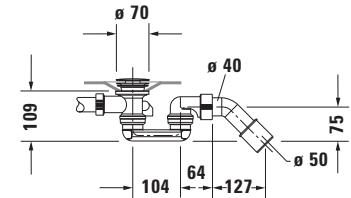
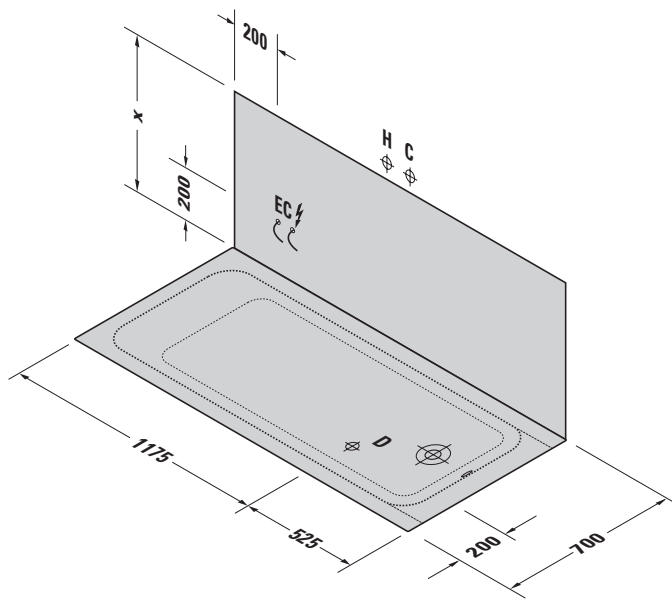

Siphon for bathtub # 700098

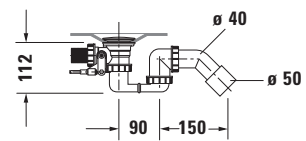

Siphon for whirltub # 760098

- H Hot water connection
- C Cold water connection
- D Drain connection
- EC Electricity connection

	Height	including feet	including support	including panel
X Bathtub	420	535 - 600	~ 540	550
X Whirltub	-	540 - 575	-	550

Technical specifications

Net weight kg	Floor load kg/m ²	Shipping weight kg	Shipping dimensions l x w x h (cm)	Water inlet OD, ID	Whirlsystem	Model-No.
19,5	159	34,5	120 x 80 x 185	-		700098 . . . 0 00 0000
28,0	166	58,0	190 x 88 x 75	-	Jet Project	760098 00 0 JP 1000

Pre-installation D-Code # 700099/760099

↳ 1700 x 750 x 400 ‹

Design by Sieger Design

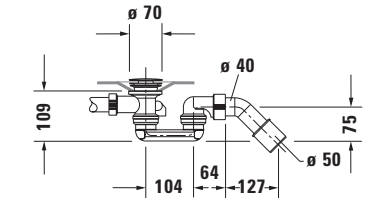
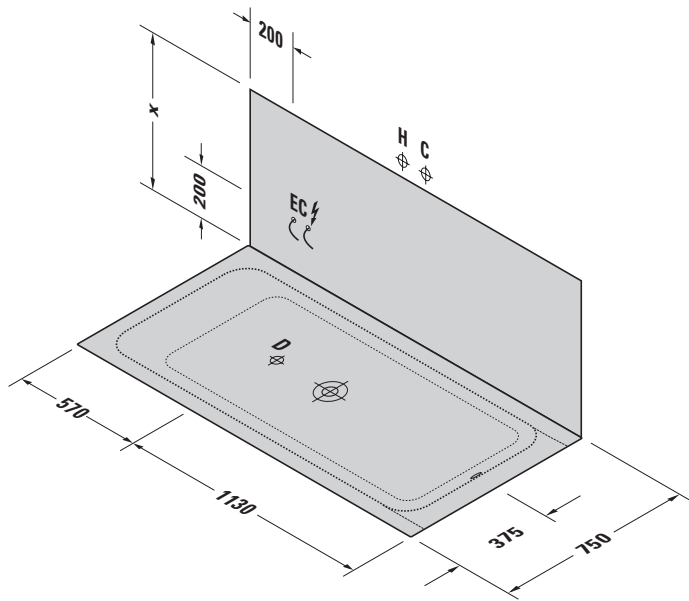

Siphon for bathtub # 700099

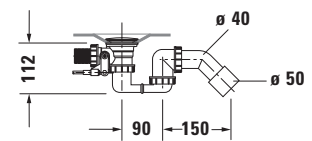

Siphon for whirltub # 760099

- H Hot water connection
- C Cold water connection
- D Drain connection
- EC Electricity connection

	Height	including feet	including support	including panel
X Bathtub	420	535 - 600	~ 535	550
X Whirltub	-	540 - 575	-	550

Technical specifications

Net weight kg	Floor load kg/m ²	Shipping weight kg	Shipping dimensions l x w x h (cm)	Water inlet OD, ID	Whirlsystem	Model-No.
20,0	157	35,0	120 x 80 x 185	-		700099 . . . 0 00 0000
28,0	163	58,0	190 x 88 x 75	-	Jet Project	760099 00 0 JP 1000

Pre-installation D-Code # 700100/760100

↳ 1700 x 750 x 400 ‹

Design by Sieger Design

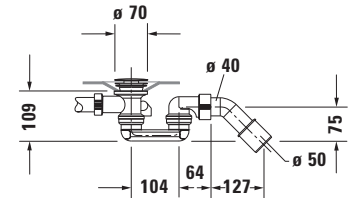
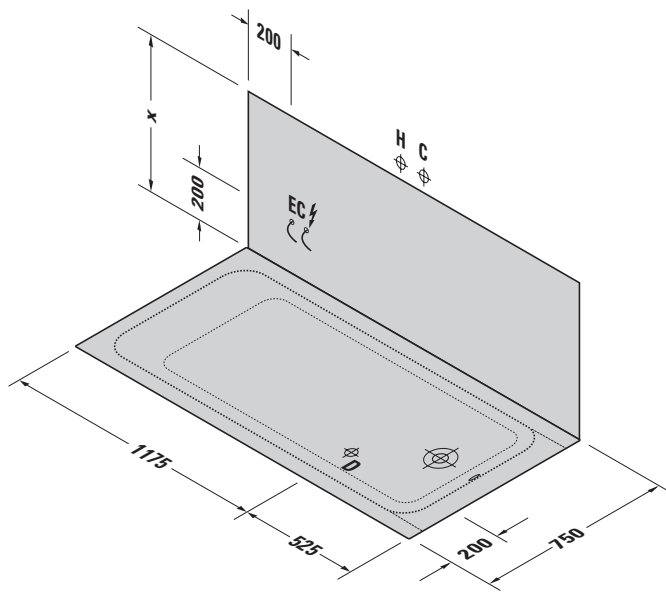

Siphon for bathtub # 700100

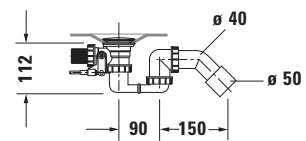

Siphon for whirltub # 760100

- H Hot water connection
- C Cold water connection
- D Drain connection
- EC Electricity connection

	Height	including feet	including support	including panel
X Bathtub	420	535 - 600	~ 535	550
X Whirltub	-	540 - 575	-	550

Technical specifications

Net weight kg	Floor load kg/m ²	Shipping weight kg	Shipping dimensions l x w x h (cm)	Water inlet OD, ID	Whirlsystem	Model-No.
20,0	157	35,0	120 x 80 x 185	-		700100 . . . 0 00 0000
28,0	163	58,0	190 x 88 x 75	-	Jet Project	760100 00 0 JP 1000

Pre-installation D-Code # 700101/760101

↳ 1800 x 800 x 400 ‹

Design by Sieger Design

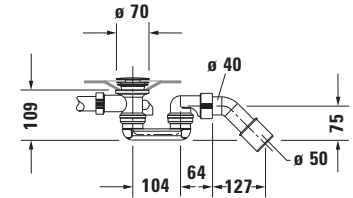
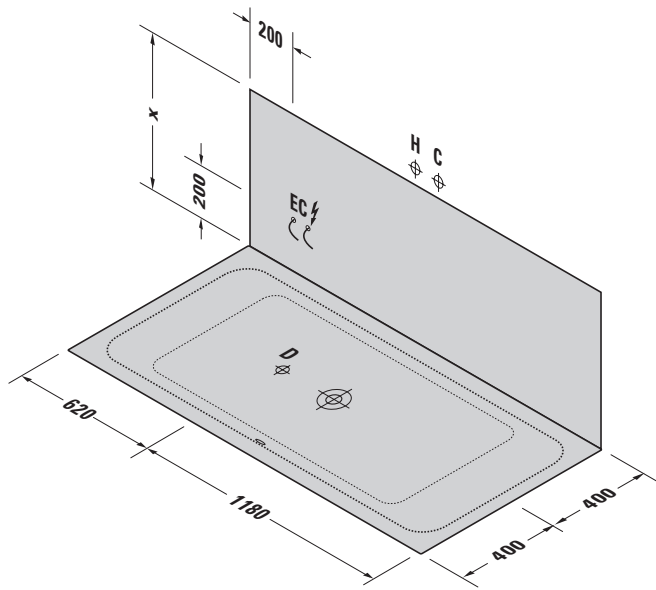

Siphon for bathtub # 700101

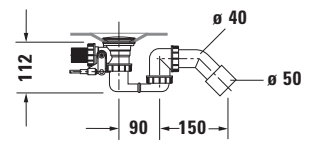

Siphon for whirltub # 760101

- H Hot water connection
- C Cold water connection
- D Drain connection
- EC Electricity connection

	Height	including feet	including support	including panel
X Bathtub	420	535 - 600	~ 540	550
X Whirltub	-	540 - 575	-	550

Technical specifications

Net weight kg	Floor load kg/m ²	Shipping weight kg	Shipping dimensions l x w x h (cm)	Water inlet OD, ID	Whirlsystem	Model-No.
23,5	162	38,5	120 x 80 x 195	-		700101 . . . 0 00 0000
32,0	168	62,0	190 x 88 x 75	-	Jet Project	760101 00 0 JP 1000

Pre-installation D-Code # 700137/760137

↳ 1400 x 1400 x 400 ‹

Design by Sieger Design

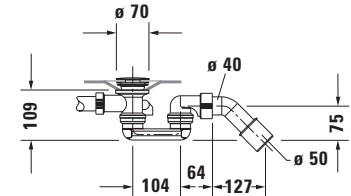
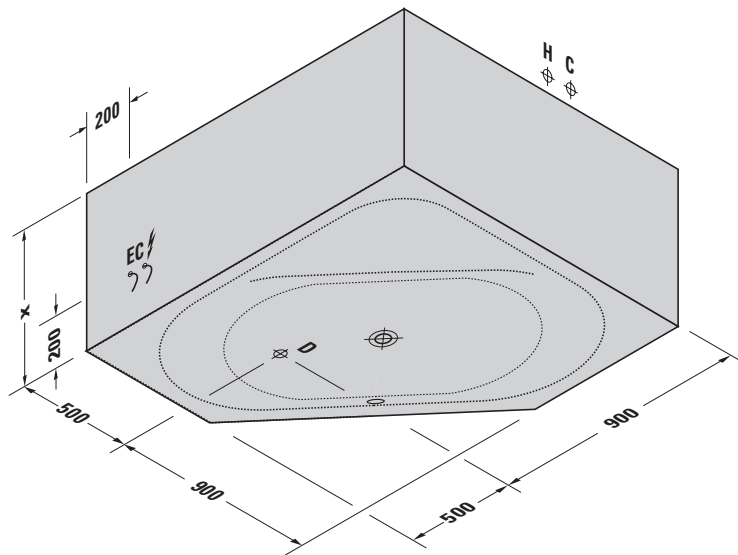

Siphon for bathtub # 700137

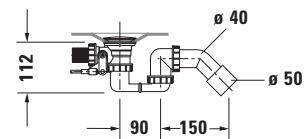

Siphon for whirltub # 760137

- H Hot water connection
- C Cold water connection
- D Drain connection
- EC Electricity connection

	Height	including feet	including support	including panel
X Bathtub	420	535 - 600	~ 540	-
X Whirltub	-	540 - 575	-	-

Technical specifications

Net weight kg	Floor load kg/m ²	Shipping weight kg	Shipping dimensions l x w x h (cm)	Water inlet OD, ID	Whirlsystem	Model-No.
26,0	115	41,0	200 x 80 x 155	-		700137 . . . 0 00 0000
34,0	119	82,0	184 x 144 x 93	-	Jet Project	760137 00 0 JP 1000

Pre-installation D-Code # 700138/760138

↳ 1900 x 900 x 400 ‹

Design by Sieger Design

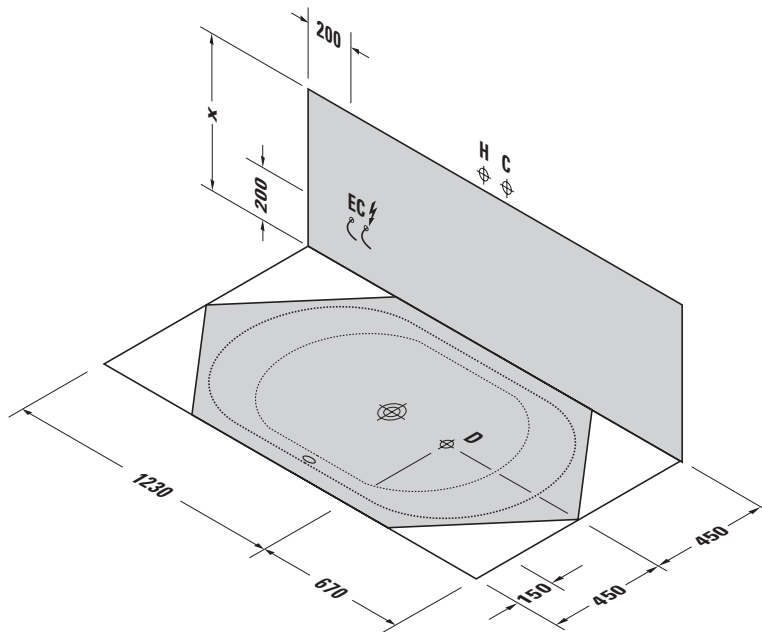

- H Hot water connection
- C Cold water connection
- D Drain connection
- EC Electricity connection

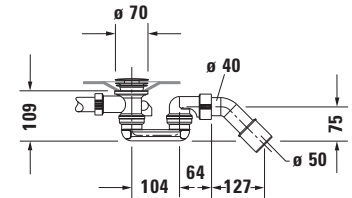

Siphon for bathtub # 700138

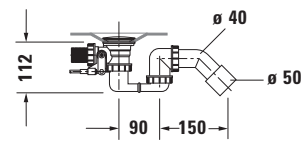

Siphon for whirltub # 760138

	Height	including feet	including support	including panel
X Bathtub	420	535 - 600	~ 540	-
X Whirltub	-	540 - 575	-	-

Technical specifications

Net weight kg	Floor load kg/m ²	Shipping weight kg	Shipping dimensions l x w x h (cm)	Water inlet OD, ID	Whirlsystem	Model-No.
26,5	132	41,5	200 x 100 x 57	-		700138 . . . 0 00 0000
35,0	137	65,0	190 x 88 x 75	-	Jet Project	760138 00 0 JP 1000

DURAVIT AG
P.O. Box 240
Werderstr. 36
78132 Hornberg
Germany
Phone +49 78 33 70 0
Fax +49 78 33 70 289
info@duravit.com
www.duravit.com

