

Belfast Sink 60x46x26 Weir Overflow

ILLUSTRATED

- S5827** Belfast sink 60 x 46 x 26cm heavy duty
- S9250** Leg 650mm stainless steel with screw to wall Aluminium alloy bearer, 405mm overall, 355mm stud (pair).
- S5835** Belfast drainer plain 61 x 46cm reversible, for sinks at least 455mm wide
- S9268** Leg 900mm stainless steel with 405mm screw to wall Aluminium alloy bearer, 355mm stud, for drainer
- B1457** Alterna 21 bib taps 1/2" lever handles with anti-vandal outlet (pair)
- B1688** Nimbus 21 exposed bib tap wall mount with self centralising installation (pair)
- S8769** Waste 1½" slotted waste, chain and plug, screw stay, 90mm tail
- S8925** Trap 1½" plastic resealing bottle with 75mm seal, multi-purpose outlet

OPTIONS

- B1673** Nimbus 21 1/2" bib taps with anti-vandal outlet (pair)
- S9219** Brackets build-in Aluminium alloy, 405mm overall, 355mm stud (pair)
- S8725** Waste 1½" slotted strainer waste, 80mm tail
- S8915** Trap 1½" plastic bottle with 75mm seal, multi-purpose outlet
- A5900** TMV thermostatic mixing valve, 15mm

ILLUSTRATED PRODUCT DETAILS









Weights

- S5827** 27.00 KG
- S9250** 2.00 KG
- S5835** 14.00 KG
- S9268** 2.00 KG
- S8769** 0.41 KG
- S8925** 0.33 KG

Materials

- S5827** Fine Fireclay
- S9250** Stainless Steel
- S5835** Fine Fireclay
- S9268** Stainless Steel
- B1457** Chrome Plated Brass
- B1688** Chrome Plated Brass
- S8769** Chrome Plated Metal
- S8925** Plastic

Finishes

- S5827**  White (01)
- S9250**  Stainless Steel finish (MY)
- S5835**  White (01)
- S9268**  Stainless Steel finish (MY)
- B1457**  Chrome (AA)
- B1688**  Chrome (AA)
- S8769**  Chrome (AA)
- S8925**  Neutral / No Finish (67)

Standards

Sinks conform to BS 1206: 1974

Special Notes

Stainless steel leg can be reduced in height on site.
Recommended 900mm legs when used with fireclay drainer.

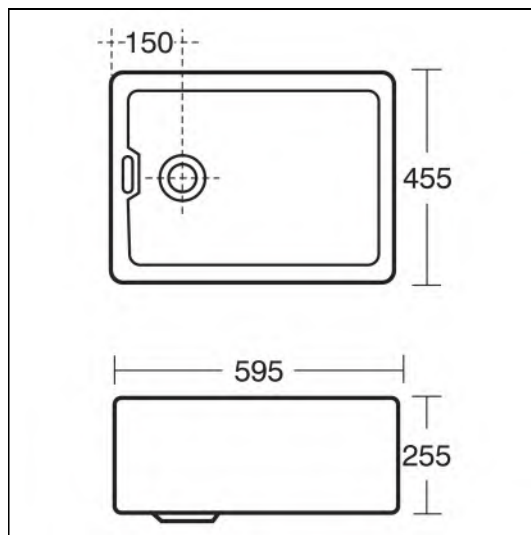

Belfast Sink 60x46x26 Weir Overflow

Consideration may be given to safe hot water delivery and the use of an appropriate temperature reduction device see A5900AA