

# RUSTIQUE FIRE CLAY CERAMIC INSET OR UNDERMOUNT SINK

CRUB3216WH/



Size: 595 x 460 mm

Fitted as either an inset or undermount sink, the Rustique kitchen sink collection provides a real focal point in the kitchen and contrasts excellently to all colours and features.

- Waste kit included
- 10 year warranty

**RANGemaster**  
sinks & taps

Material	Fire clay Ceramic
Material Gauge	-
Material Finish Bowl	-
Material Finish Drainer	-
Drainer Position	
Overall Length (mm)	595
Overall Width (mm)	460
Main Bowl Length (mm)	337
Main Bowl Width (mm)	400
Main Bowl Depth (mm)	196
Second Bowl Length (mm)	183
Second Bowl Width (mm)	384
Second Bowl Depth (mm)	176
Tap hole Size (mm)	-
Waste Size (mm)	2 x 90
Waste Kit	Included with sink (2 x 90mm BSW & overflow kit)
Min. Base Unit (mm)	600
Cutout Size Length (mm)	525 / 570
Cutout Size Width (mm)	390 / 435
Warranty Sinks (years)	10
Product Code	CRUB3216WH/
Barcode	5015834049830

Date of download: August 29, 2022

AGA Rangemaster continuously seeks improvements in specification, design and production of products and thus, alterations take place periodically. Whilst every effort is made to produce up-to-date resources, the information included here is intended as a guide. Always refer to the product's installation instructions when fitting, installation work should be completed a professional tradesman.

# RUSTIQUE FIRE CLAY CERAMIC INSET OR UNDERMOUNT SINK

CRUB3216WH/

Technical Drawing

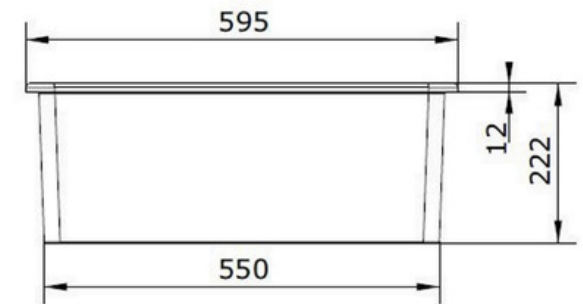
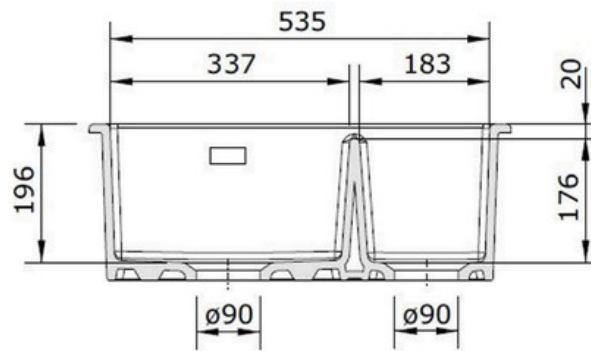
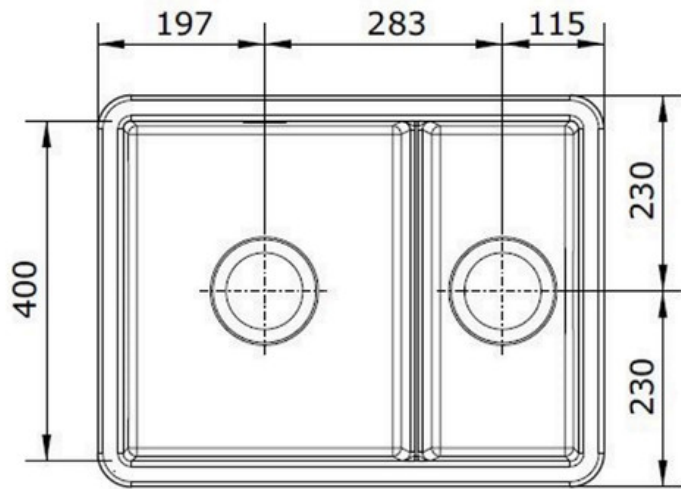

*NB: Due to manufacturing processes this sink may have a +/- 3mm tolerance on the measurements.*

AGA Rangemaster continuously seeks improvements in specification, design and production of products and thus, alterations take place periodically. Whilst every effort is made to produce up-to date resources, the information included here is intended as a guide. Always refer to the product's installation instructions when fitting, installation work should be completed a professional tradesman.

# RUSTIQUE FIRE CLAY CERAMIC INSET OR UNDERMOUNT SINK CRUB3216WH/

Cut Out Template  
Dimensions in mm. Not to scale.

## UNDERMOUNT INSTALLATION

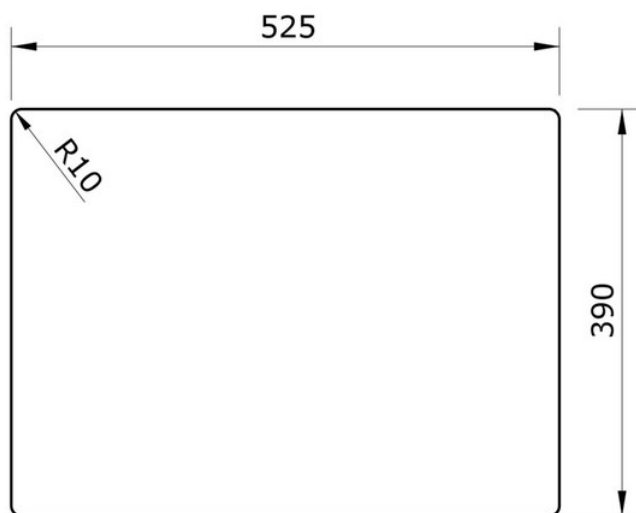

## INSET INSTALLATION

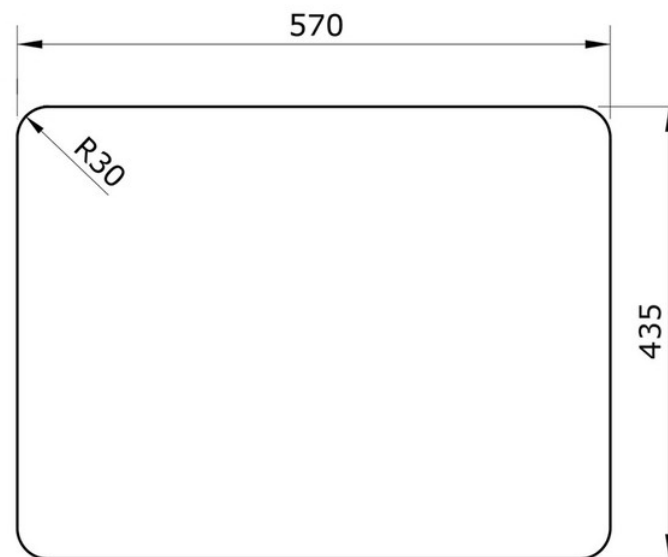

Date of download: August 29, 2022

AGA Rangemaster continuously seeks improvements in specification, design and production of products and thus, alterations take place periodically. Whilst every effort is made to produce up-to date resources, the information included here is intended as a guide. Always refer to the product's installation instructions when fitting, installation work should be completed a professional tradesman.