

INSTRUCTION MANUAL

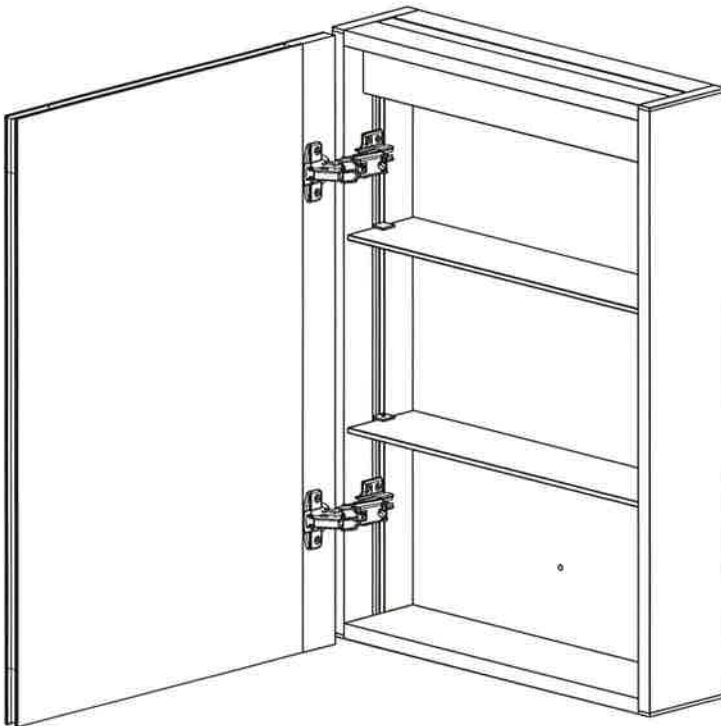

Note: This specification applies to Single door infrared induction switch LED Aluminum Cabinets

MODEL: MIR101/MIR102/MIR103/MIR104/MIR105/MIR106

Wall Mounted Mirror Cabinet 500x700mm

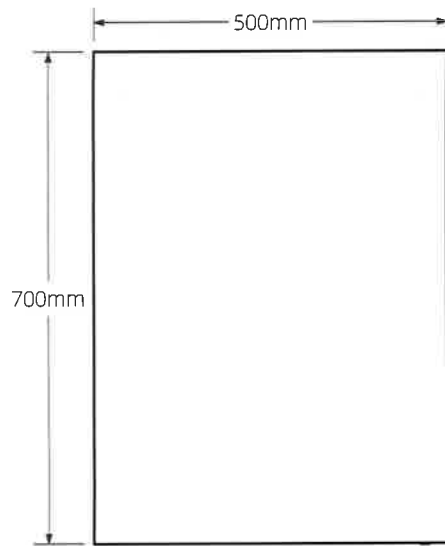

Front View



Side View

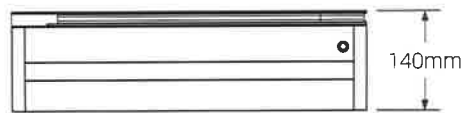

Bottom View

- Adjustable stainless steel buffer hinge
- Double layer adjustable tempered glass shelf
- Infrared sensor switch
- Aluminum alloy cabinet
- Double-sided copper-free silver mirror

Adjustable Hinge

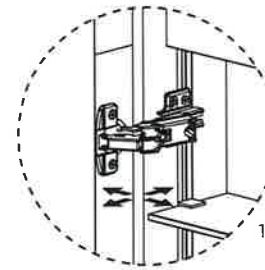

Shaver Socket

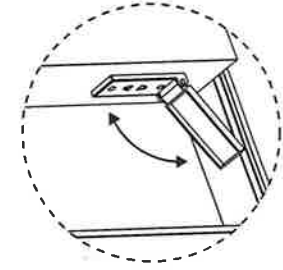

165° opening and closing range

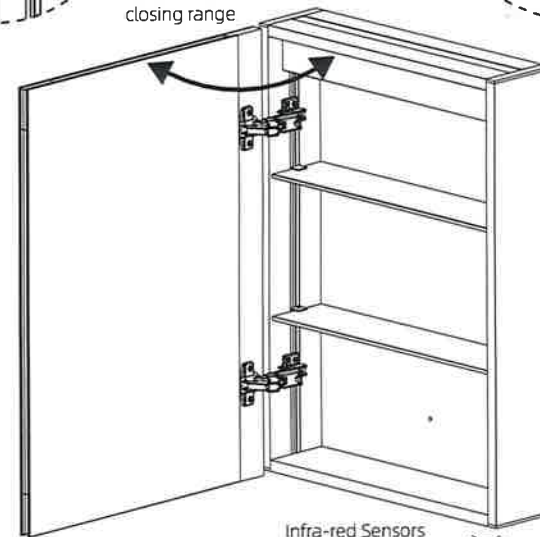

Infra-red Sensors
80° induction range
50cm induction distance

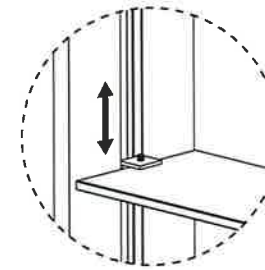

Adjustable Glass Shelving Panel

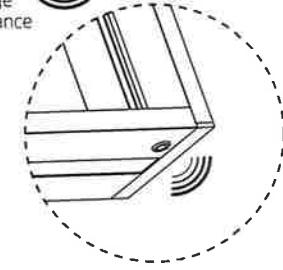

Infra-red Sensors

Packing List

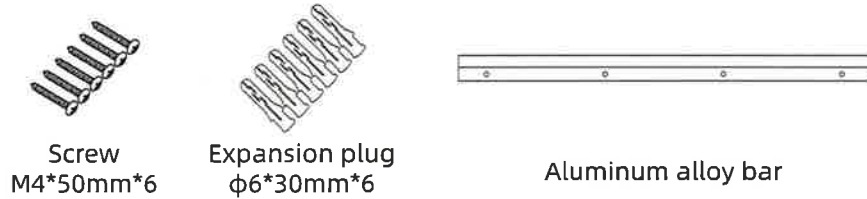

Screw
M4*50mm*6

Expansion plug
φ6*30mm*6

Aluminum alloy bar

Required Tools

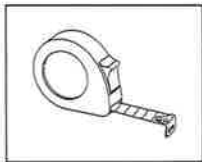

Flexible rule

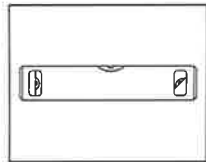

Spirit level

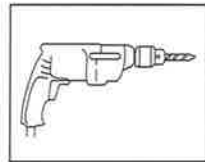

Drill

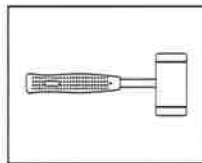

Hammer

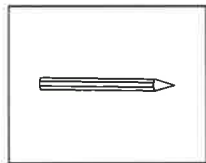

Pencil

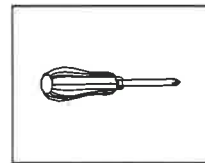

Screwdriver

! Please Note

1. Before installing the product, please carefully read the instructions and operate accordingly.
2. Before installing, please turn off the main power switch and ensure that it won't turn on.
3. The installation of this product requires that the staff has some electrical knowledge.
4. This mirror cabinet is heavy; do not lift or install with single person in order to avoid injury.
5. Before installing, please check whether the product is broken, to avoid injury caused by damaged glass.
6. Do not clean the product surface with acid and alkaline cleaning agent; please use a damp cloth.
7. In case of functional failure of the product, users are not allowed to disassemble and repair without authorization, otherwise, our company will not be responsible for any safety accidents.

Installation Step

1. Fixing the bar

- ① Open the product packaging, and check whether the product has any exception or functional damage; if yes, please return it to the dealer.
- ② After selecting the location of the mirror cabinet, check whether the wall is solid, measure the distance of the holes (a1, a2, a3) in the aluminum alloy bar with a tape measure and mark the wall with a level and pencil (Fig. 1).
- ③ Drill holes in the marked position with electric drill and φ4 drill bit, and use special ceramic drill if the wall surface is ceramic tile.
- ④ Knock the expansion plugs into the holes in the wall with a hammer, and then tighten the screws with a screwdriver to fix the bar, and calibrate the level with a spirit level (Fig. 2).

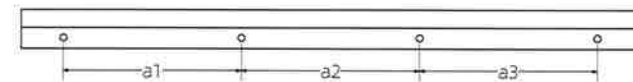

Fig.1

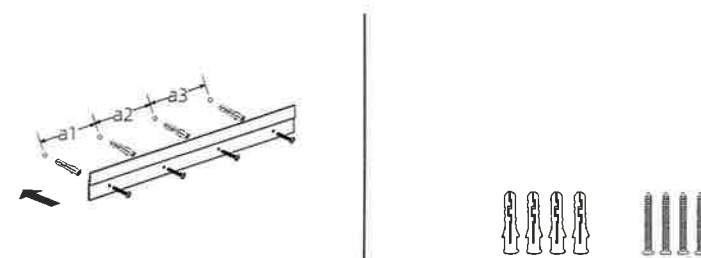

Fig.2

Installation Steup

2. Positioning and Installation of Mirror Cabinet

- ① Attach the mirror cabinet to the bar as shown in Fig. 3, open the cabinet door, and mark on the wall (b2) with a pencil through the backplane hole (b1).
- ② Remove the mirror cabinet, drill the fixing hole in the wall in the marked position, and place the expansion plugs (Fig. 4).
- ③ Repeat the operation as shown in Fig. 3 and mount the mirror cabinet to the bar, and then tighten the screws on the backplane (Fig. 5).
- ④ Finally, turn on the main switch, and test if the switch works normally.

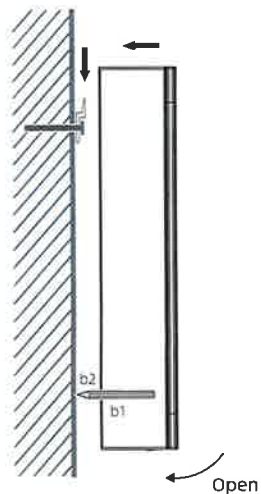

Fig. 3

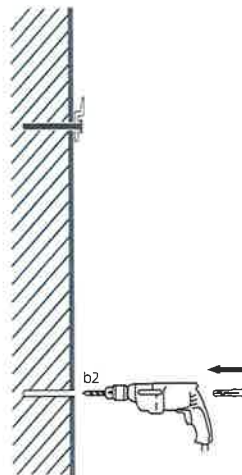

Fig. 4



Fig. 5

⚠ Please Note

Products with an IR Sensor must be installed with a minimum of 200mm between the sensor and any solid object or reflective surface.

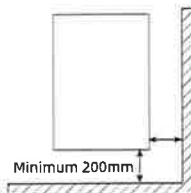

Wiring Diagram for Input

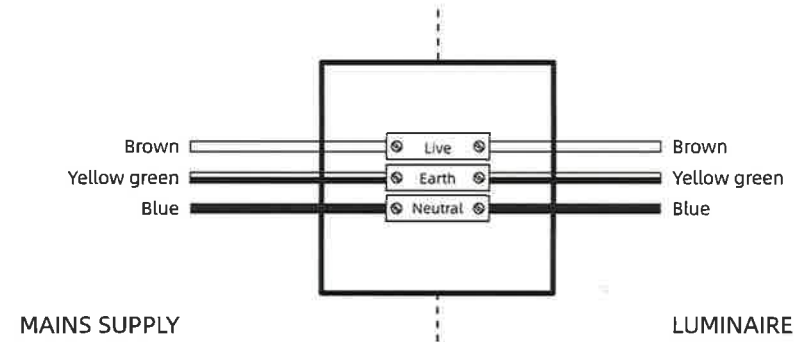

Schematic Diagram

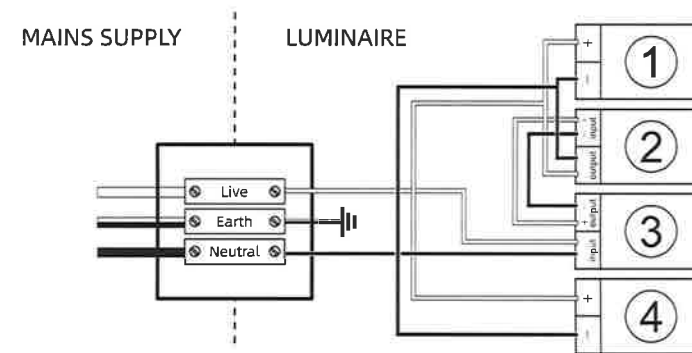

- ① LED strip
- ② Infra-red sensors
- ③ Supply power
- ④ Defogger pad



Waste Electrical & Electronic Equipment Regulations (WEEE) requires that any of our products showing this mark (left) must not be disposed off with other household or commercial waste. We do not levy any WEEE disposal charges to its customers for affected WEEE related products. To prevent possible harm to the environment or human health from uncontrolled waste disposal, please separate any such product from other waste types and recycle it responsibly at your local facilities. Check with your Local Authority, Recycling Center or retailer for recycling advice.