

ILLUMINATED MIRRORS - LED

IMPORTANT ADVICE & SAFETY - please read before installation

Thank you for buying this Crosswater Product.

Please read these instructions carefully before starting installation and keep in a safe place for future reference.

Check the contents of the pack carefully before installation. Responsibility will not be held for any de-fit / re-fit costs where faulty product has been fitted. If any fault is found with materials or workmanship, it must be reported immediately to the manufacturer. Remedial action will be taken, based on information received, on condition that: 1. Full details are supplied to the manufacturer; 2. The product has not been modified or tampered with; 3. The manufacturer is informed of any damage/shortages prior to installation. 4. The product has not been installed, or attempts have been made to install. We do not accept responsibility for any problems that may occur through incorrect installation. ENSURE the room is well heated and ventilated.

Any modification to the supplied product will negate all product guarantees. Before drilling ensure there are no hidden cables or pipes(water, gas or electrical) behind hanging points. Always wear suitable eye protection when drilling. Ensure the wall surface is able to take the weight of the complete product.

Please use the supplied wall fixing bracket and follow the correct installation method. If the instructions are not followed appropriately there is an increased safety risk to the user. It is important to install light fittings in the correct bathroom zone i.e. the zone referred to in the IP rating of the element. This is not an installation guide and reference should be made to the latest edition of the IET Wiring Regulations or a qualified electrician member of NICEIC or IET.

ZONE 0 is inside the bath or shower tray itself. Any appliance used in this zone must be rated at least IP67 which is total immersion proof.

ZONE 1 is the area above the bath or shower tray to a height of 2.25m from the floor. In this zone a minimum rating of IPX4 Splash-proof is required and elements must also be protected by a 30mA residual current device (RCD) to protect the circuit.

The electrical connection to the power supply for these appliances must be in Zones 2/3 of the bathroom in compliance with BS 7671:2008(2011) - IET Wiring Regulations.

ZONE 2 is an area stretching 0.6m outside the perimeter of the bath and to a height of 2.25m from the floor. In this zone an IP rating of at least IP44 is required. In addition it is good practice to consider the area around a washbasin, within a 60cm radius of any tap to be considered as zone 2.

Appliance must also be protected by a 30mA residual current device (RCD) to protect the circuit.

It is recommended that all electrical bathroom products should only be fitted by a suitably qualified, Part P registered electrician in accordance with current IEE regulations. Failure to have electrical products installed and certificated by a qualified electrical engineer will invalidate any product guarantee. For full details reference should be made to the latest copy of the IET wiring regulations and all applicable British Standard and European norm specifications.

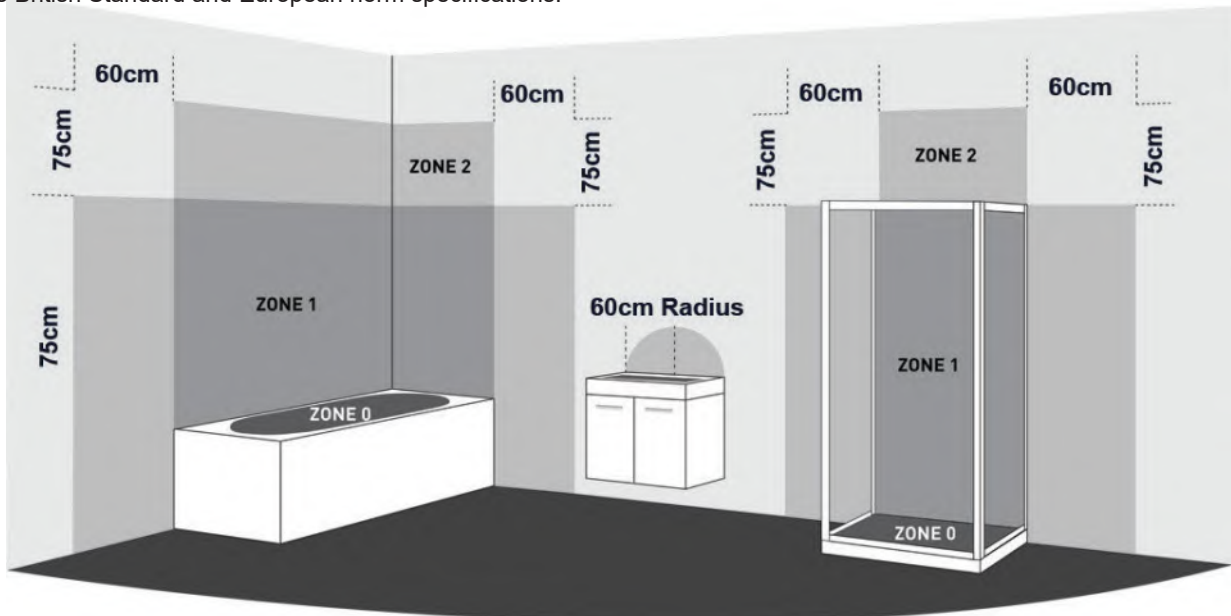

This product is IP44 rated and is suitable for installation within zone 2 above, and complies with the following safety standards: EN 60598-2-1:1989, EN 60598-1:2015, EN 62493:2015

WIRING DIAGRAM

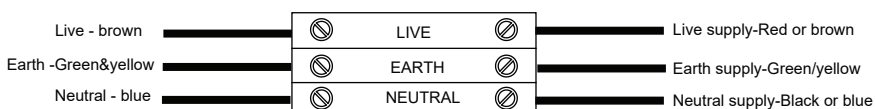

This product is Class I rated and MUST be earthed.
Supply 240v/50hZ maximum



crosswater®

INSTALLATION INSTRUCTIONS

It is recommended that walls are fully tiled/finished before installation. This ensures that the product is installed flat to the wall face and allows product to be easily removed if required in the future.

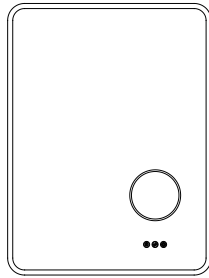

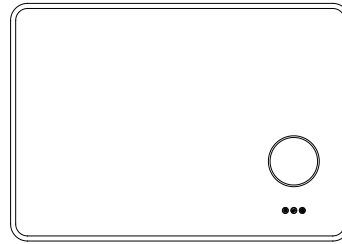

SE6080

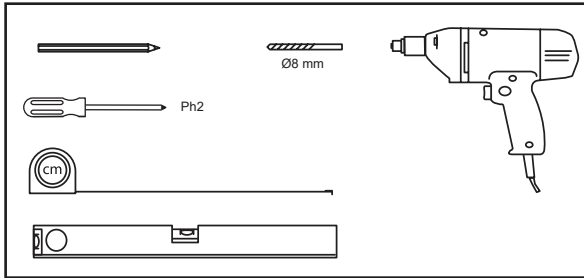

SE100070



Remove all outer packing and carefully check the product is in perfect condition. The mirror is supplied with a protective film DO NOT remove this until installation is complete.

-  6 x wall fixing screws
-  6 x wall plugs for solid wall only
-  2 x wall brackets

STEP 1

Offer the mirror up to the desired wall location considering the safety zone requirements. Using spirit level ensure the mirror is level and upright and mark top of mirror. Using a soft pencil mark carefully the 2 fixing points.

	A	B	C	D
SE6080	260mm	80mm	97mm(±5)	145mm(±5)
SE100070	460mm	80mm	415mm(±5)	150mm(±5)

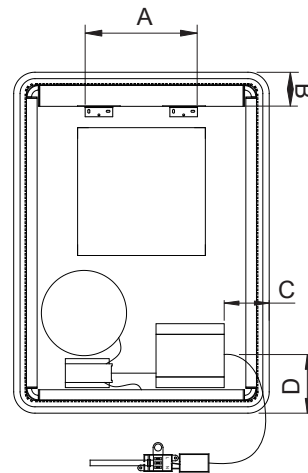

STEP 2

Carefully drill the required holes and insert wall plugs. Prepare the power supply. Note screws and plugs supplied are suitable for solid walls only.

 ENSURE THAT THE MAINS VOLTAGE SUPPLY TO WHICH THE MIRROR IS BEING CONNECTED IS ISOLATED

Hold the mirror frame in the correct position, insert screws and screw into wall plugs, ensure they are secure and the electrical mains supply cable free from obstruction.

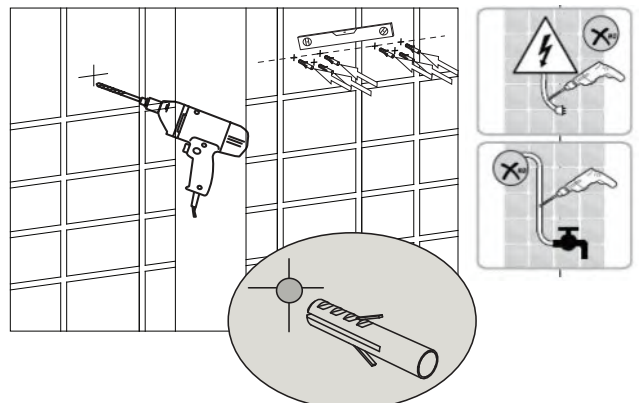

STEP 3

Remove the cover from the electrical connection box. Using a suitable terminal screwdriver make secure connections as follows:

Colour Coding:

L - Live = Brown

N - Neutral = Blue

Earth = Green & Yellow

THIS PRODUCT IS MANUFACTURED TO CLASS I CATEGORY AND MUST HAVE AN EARTH CONNECTION

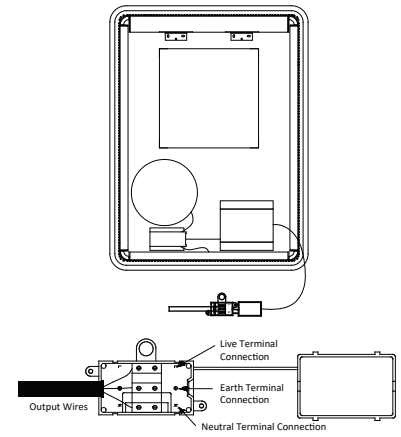

STEP 4

Hang the mirror onto brackets.

Apply a bead of clear silicone sealant on all sides between the mirror frame and wall surface. Allow to dry for 24 hours.

Reconnect the electrical power supply.

Remove protective film from the mirror face, and clean as directed below.

OPERATING INSTRUCTIONS

To turn the mirror lights on or off, activate the switch by pressing

The heated pad only works when the mirror is illuminated via the touch switch.

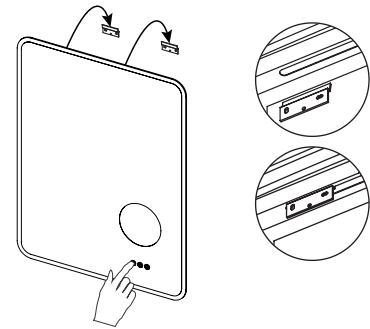

- ON/OFF
- Change temperature colour
- Dimmer light density

LED Type

Model	Led Parameter	Led Driver
SE6080	282+66 Leds	15 W
SE100070	378+66 Leds	15 W

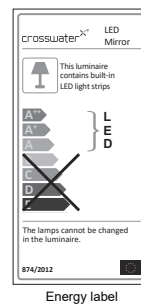

Waste Electrical & Electronic Equipment Regulations (WEEE) requires that any electrical products showing the mark above must not be disposed of with other household or commercial waste. To prevent possible harm to the environment or human health from uncontrolled waste disposal, please separate any such product from other waste types and recycle it responsibly at your local facilities. Check with your Local Authority, Recycling Center or retailer for recycling advice.

CARE & MAINTENANCE

LED light strips last for thousands of hours under normal domestic use, in the unlikely event that the LED light strip should fail please contact customer services for a replacement part.

Do not strike/hit glass components with hard or pointed items. Do not place very hot or very cold items against or in close proximity to glass surfaces unless a suitably thick insulation material is used.

The nominal thickness of the mirror glass used in this product is 5mm and is safety film backed in accordance to BS:EN6206 for your safety. If the mirror glass becomes chipped or broken, replace immediately. For details on replacement mirror glass and other components contact customer services.

Cleaning:

The mirror edges are treated with a specially formulated sealant designed to protect the mirror edges from contaminants and discolouring. Failure to follow cleaning guide-lines can/will remove the benefits of the sealant.

NEVER use products containing bleach, cleaners of a gritty or abrasive nature or so called "glass and mirror" cleaning products, that can be detrimental to the long lasting finish of the mirror.

ONLY use a clean micro fibre cloth to clean the mirror and mirror frame.

crosswater[®]

© Crosswater Copyright:
No part of this document may be reprinted or duplicated without Crosswater's consent. In the interests of continued product development Crosswater reserves the right to alter specification without prior notification. E & OE.
Feb 2022

For any further information please contact call us on:
0345 873 8840

Or visit our web-site at:
www.crosswater.co.uk

(V02, APR 2022)