

Sales Code: ATH055W

Description: 800 Fs 2-Drawer Vanity & Worktop

### Packaging Details

Barcode: 5056211801771

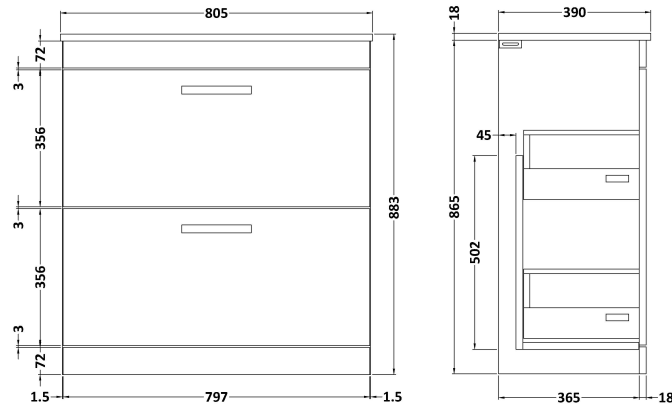

Sales Code: ATH055B

Description: 800 Fs 2-Drawer Vanity & Basin 2

### Packaging Details

Barcode: 5056211800460

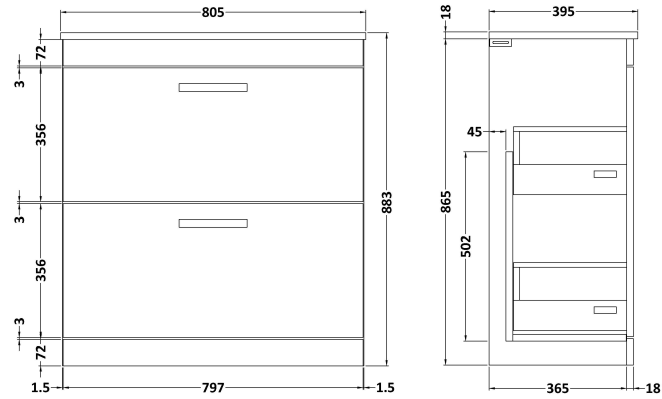

Sales Code: ATH055A

Description: 800 Fs 2-Drawer Vanity & Basin 1

### Packaging Details

Barcode: 5055275899748

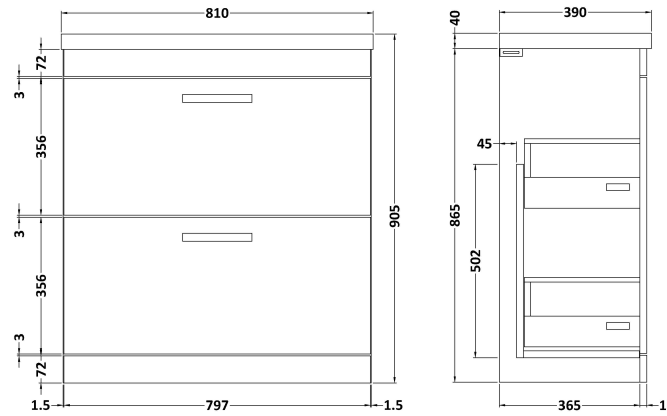

Sales Code: ATH055D

Description: 800 Fs 2-Drawer Vanity & Basin 3

### Packaging Details

Barcode: 5056211864141

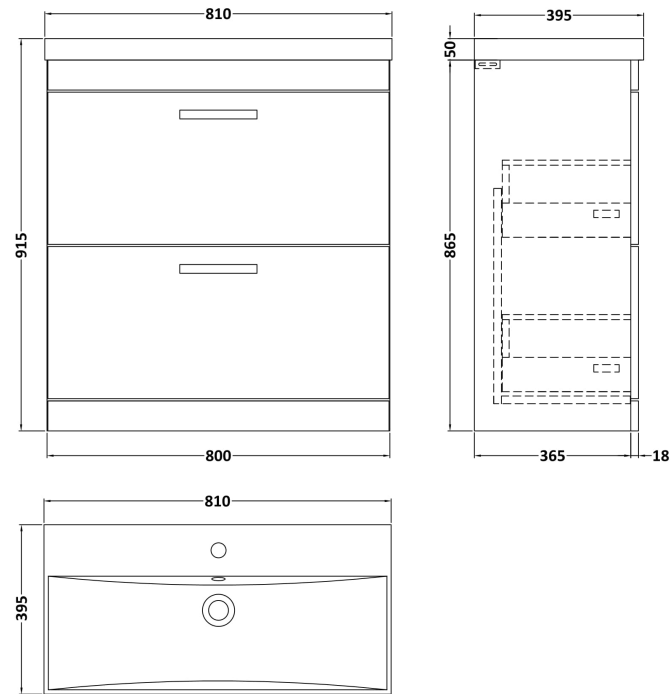

Sales Code: ATH055G

Description: 800 Fs 2-Drawer Vanity & Basin 4

### Packaging Details

Barcode: 5056462622354

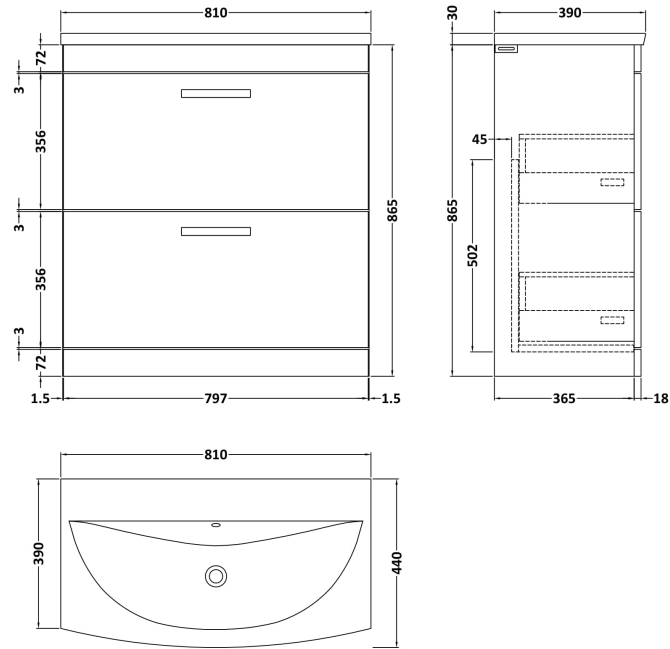

Sales Code: MOE105

Description: 800 Floor Standing 2-Drawer Basin Unit

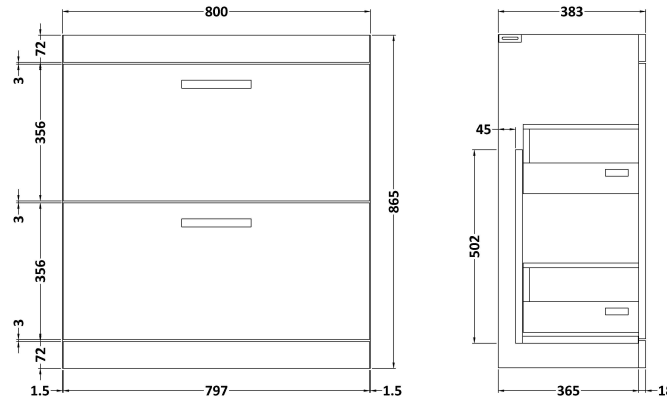

### Product Dimensions

Height (mm):	865
Width (mm):	800
Depth (mm):	383
Nett Weight (kg):	31.5

### Packaging Dimensions

Height (mm):	405
Width (mm):	820
Depth (mm):	885
Gross Weight (kg):	32

### Packaging Data

Box Colour:	Brown Cardboard Box - Printed
Box Qty:	0
Label Size:	0 x 0
Label Colour:	White Label
Label Qty:	2

### Outer Box Dimensions (If Applicable)

Height (mm):	
Width (mm):	
Depth (mm):	
Gross Weight (kg):	
Barcode:	5055275880708

### Product Details

Country of Origin:	China
Fitting Instruction:	No
CE Certification:	N/A
FSC Certified Materials:	Yes
Colour:	Gloss White
Construction Method:	Cam & Wood Dowel
Construction Type:	Rigid
Cabinet Finish:	MFC Painted Gloss
Fascia Finish:	Mdf Painted Gloss
Cabinet Thickness (mm):	16
Fascia Thickness (mm):	18
Drawer Included:	Yes
Drawer Type:	80mm High Metal S/C Inc Galler
No of Shelves:	0
Hinge Type:	Not Applicable
Hinge Included:	Not Applicable
Adjustable Legs:	No, Not Required
Fixings Included:	Yes
Handle Style:	Contemporary
Waste Shroud:	Yes
Handle Included:	Yes, Supplied
Handle Type:	D-Shape

Sales Code: MWD170

Description: 800 Worktop (805X390x18mm)

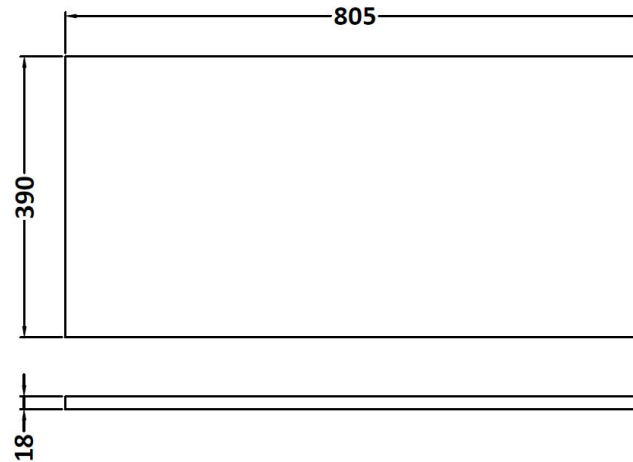

### Product Dimensions

Height (mm):	18
Width (mm):	805
Depth (mm):	390
Nett Weight (kg):	3.5

### Packaging Dimensions

Height (mm):	25
Width (mm):	825
Depth (mm):	410
Gross Weight (kg):	3.5

### Packaging Data

Box Colour:	Brown Cardboard Box - Printed
Box Qty:	
Label Size:	x
Label Colour:	Not Applicable
Label Qty:	0

### Outer Box Dimensions (If Applicable)

Height (mm):	
Width (mm):	
Depth (mm):	
Gross Weight (kg):	
Barcode:	5055275893524

### Product Details

Country of Origin:	China
Fitting Instruction:	No
CE Certification:	
FSC Certified Materials:	
Colour:	Gloss White
Construction Method:	Not Applicable
Construction Type:	Not Applicable
Cabinet Finish:	Not Applicable
Fascia Finish:	MFC Painted Gloss
Cabinet Thickness (mm):	
Fascia Thickness (mm):	18
Drawer Included:	Not Applicable
Drawer Type:	Not Applicable
No of Shelves:	Not Applicable
Hinge Type:	Not Applicable
Hinge Included:	Not Applicable
Adjustable Legs:	Not Applicable
Fixings Included:	Yes
Handle Style:	Not Applicable
Waste Shroud:	Not Applicable
Handle Included:	Not Applicable
Handle Type:	Not Applicable

Sales Code: NVM005

Description: Minimalist Basin 800mm

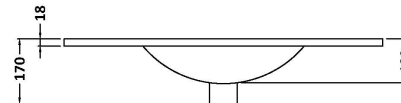
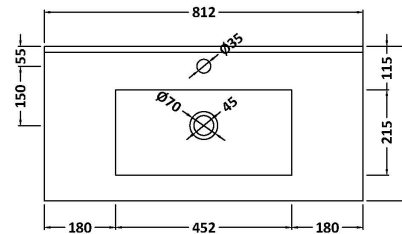
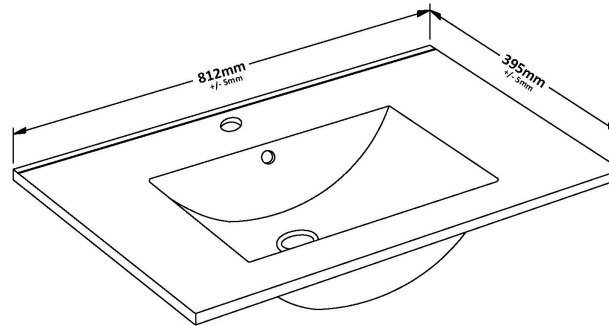

### Product Dimensions

Height (mm):	170
Width (mm):	800
Depth (mm):	390
Nett Weight (kg):	16.9

### Packaging Dimensions

Height (mm):	400
Width (mm):	820
Depth (mm):	200
Gross Weight (kg):	16.9

### Packaging Data

Box Colour:	Brown Cardboard Box - Printed
Box Qty:	1
Label Size:	100 x 50
Label Colour:	White Label
Label Qty:	2

### Outer Box Dimensions (If Applicable)

Height (mm):	
Width (mm):	
Depth (mm):	
Gross Weight (kg):	
Barcode:	5055146194675

### Product Details

Country of Origin:	China
Fitting Instruction:	No
Certification:	CE: No WRAS: N/A WRAS No: N/A
Product Material:	Vitreous China
Fixing Supplied:	No

**Pans/Bidets:** Trap Style: Not Applicable Includes Seat: Not Applicable

**Seats:** Seat Type: Not Applicable Material: Not Applicable  
Function: Not Applicable Hinge Type: Not Applicable  
Hinge Material: Not Applicable

**Cisterns:** Operating Type: Not Applicable Fittings: Not Applicable  
Lever Type: Not Applicable

**Basins:** Tap Hole: One Taphole Chain Stay Hole: No  
Template: Not Required Waste Type Req: Slotted  
Overflow Inc: Yes Overflow Cover: Yes  
Inner Bowl Depth (mm): 125mm



Sales Code: NVM015

Description: 800 Mid Edged Basin 1 Th

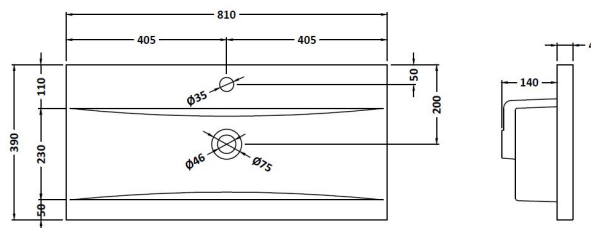

### Product Dimensions

Height (mm):	180
Width (mm):	810
Depth (mm):	390
Nett Weight (kg):	15

### Packaging Dimensions

Height (mm):	210
Width (mm):	410
Depth (mm):	830
Gross Weight (kg):	15

### Packaging Data

Box Colour:	Brown Cardboard Box
Box Qty:	1
Label Size:	100 x 50
Label Colour:	White Label
Label Qty:	2

### Outer Box Dimensions (If Applicable)

Height (mm):	
Width (mm):	
Depth (mm):	
Gross Weight (kg):	
Barcode:	5055369043422

### Product Details

Country of Origin:	China
Fitting Instruction:	No
Certification:	CE: No WRAS: N/A WRAS No: N/A
Product Material:	Vitreous China
Fixing Supplied:	No

**Pans/Bidets:** Trap Style: Not Applicable Includes Seat: Not Applicable

**Seats:** Seat Type: Not Applicable Material: Not Applicable  
Function: Not Included Hinge Type: Not Relevant  
Hinge Material: Not Applicable

**Cisterns:** Operating Type: Not Applicable Fittings: None Included  
Lever Type: Not Applicable

**Basins:** Tap Hole: One Taphole Chain Stay Hole: No  
Template: Not Required Waste Type Req: Slotted  
Overflow Inc: Not Applicable Overflow Cover: Yes  
Inner Bowl Depth (mm): 125mm

Sales Code: NVM035

Description: 800 Thin Edged Basin 1Th

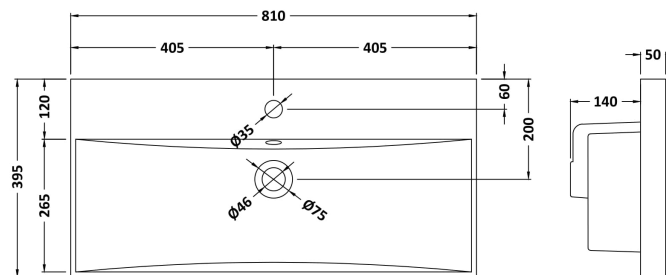

### Product Dimensions

Height (mm):	170
Width (mm):	810
Depth (mm):	395
Nett Weight (kg):	14.5

### Packaging Dimensions

Height (mm):	190
Width (mm):	830
Depth (mm):	415
Gross Weight (kg):	15

### Packaging Data

Box Colour:	Brown Cardboard Box
Box Qty:	1
Label Size:	100 x 50
Label Colour:	White Label
Label Qty:	2

### Outer Box Dimensions (If Applicable)

Height (mm):	
Width (mm):	
Depth (mm):	
Gross Weight (kg):	
Barcode:	5056211853435

### Product Details

Country of Origin:	China
Fitting Instruction:	No
Certification:	CE: No WRAS: N/A WRAS No: N/A
Product Material:	Vitreous China
Fixing Supplied:	No

**Pans/Bidets:** Trap Style: Not Applicable Includes Seat: Not Applicable

**Seats:** Seat Type: Not Applicable Material: Not Applicable  
Function: Not Included Hinge Type: Not Relevant  
Hinge Material: Not Applicable

**Cisterns:** Operating Type: Not Applicable Fittings: None Included  
Lever Type: Not Applicable

**Basins:** Tap Hole: One Taphole Chain Stay Hole: No  
Template: Not Required Waste Type Req: Slotted  
Overflow Inc: Not Applicable Overflow Cover: Yes  
Inner Bowl Depth (mm): 125mm

Sales Code: NVM045

Description: 800 Curved Basin 1Th



### Product Dimensions

Height (mm):	160
Width (mm):	810
Depth (mm):	440
Nett Weight (kg):	15

### Packaging Dimensions

Height (mm):	190
Width (mm):	830
Depth (mm):	415
Gross Weight (kg):	15.5

### Packaging Data

Box Colour:	Brown Cardboard Box
Box Qty:	1
Label Size:	100 x 50
Label Colour:	White Label
Label Qty:	2

### Outer Box Dimensions (If Applicable)

Height (mm):	
Width (mm):	
Depth (mm):	
Gross Weight (kg):	
Barcode:	5056462620978

### Product Details

Country of Origin:	China
Fitting Instruction:	No
Certification:	CE: No WRAS: N/A WRAS No: N/A
Product Material:	Vitreous China
Fixing Supplied:	No

**Pans/Bidets:** Trap Style: Not Applicable Includes Seat: Not Applicable

**Seats:** Seat Type: Not Applicable Material: Not Applicable  
Function: Not Included Hinge Type: Not Relevant  
Hinge Material: Not Applicable

**Cisterns:** Operating Type: Not Applicable Fittings: None Included  
Lever Type: Not Applicable

**Basins:** Tap Hole: One Taphole Chain Stay Hole: No  
Template: Not Required Waste Type Req: Slotted  
Overflow Inc: Not Applicable Overflow Cover: Yes  
Inner Bowl Depth (mm): 125mm