

Sales Code: KRA305DL

Description: Ravi Mono Dual Lever Chrome

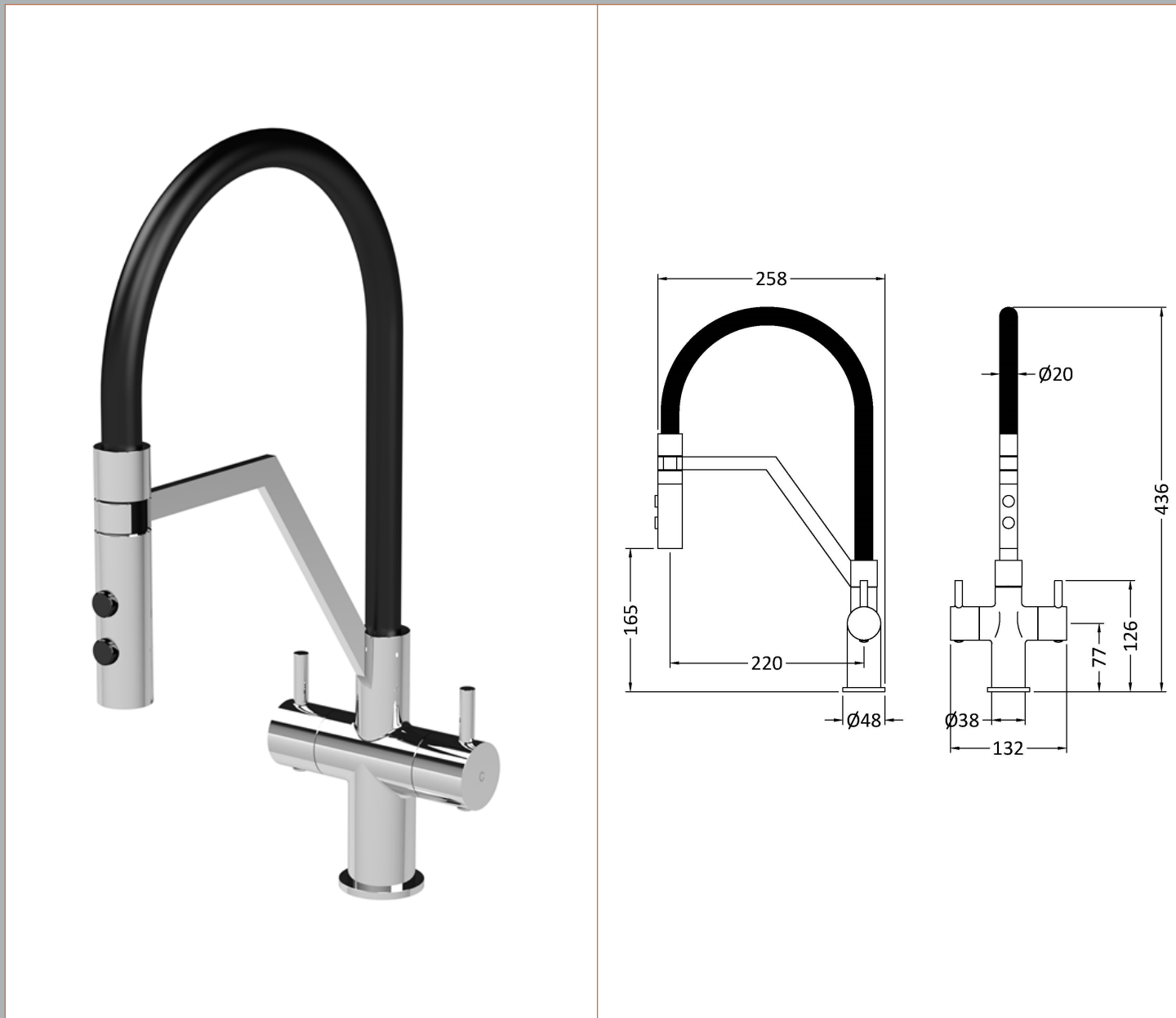

Product Dimensions

Height (mm):	436
Width (mm):	132
Depth (mm):	258
Length (mm):	
Nett Weight (kg):	1.9

Packaging Dimensions

Height (mm):	70
Width (mm):	340
Depth (mm):	460
Gross Weight (kg):	2.4

Packaging Data

Box Colour:	Brown Cardboard Box
Box Qty:	1
Label Size:	100 x 50
Label Colour:	White Label
Label Qty:	1

Outer Box Dimensions (If Applicable)

Height (mm):	395
Width (mm):	335
Depth (mm):	445
Length (mm):	
Gross Weight (kg):	10
Barcode:	5056678400975

Product Details

Country of Origin:	China
Fitting Instruction:	No
Product Material:	Brass
Control Type:	Manual
Waste Included:	Waste Not Included
Waste Type:	Not Applicable
WRAS Approval: No	Approval No: N/A
Valve/Cartridge Type:	1/4 Turn Ceramic Disc
Colour/Finish:	Chrome
Mount Type:	Deck
Operating Pressure (bar):	0.5

Flow Rates: (Litres Per Min) 0.1 bar: 1.6 0.5 bar: 3.1 1 bar: 4.3 2 bar: 6 3 bar: 7.3

Pipe Size: 15 mm (1/2" Bsp)

Pipe Centres: N/A