

**Sales Code:** FPA005

**Description:** Parade 800 W/H 2 Drawer Basin & Cabinet

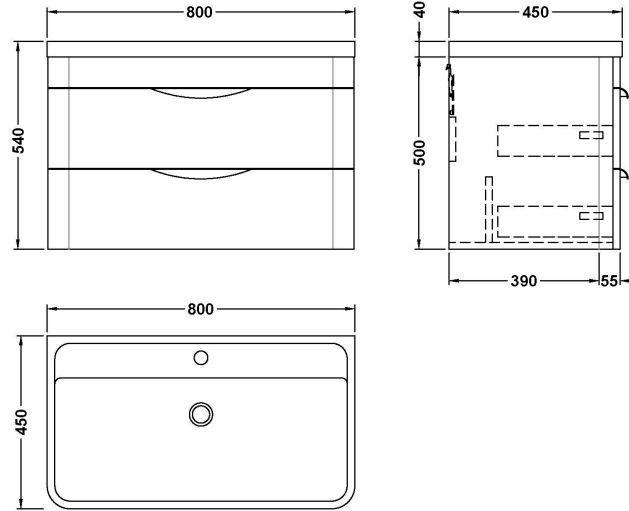

**Packaging Details**

Barcode: 5055369021826

**Sales Code:** PMP185

**Description:** 800 Wall Hung 2-Drawer Basin Unit

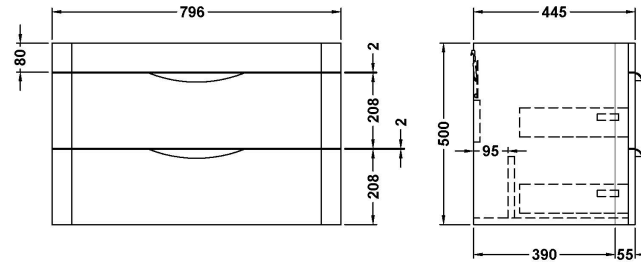

### Product Dimensions

Height (mm):	500
Width (mm):	796
Depth (mm):	445
Nett Weight (kg):	32

### Packaging Dimensions

Height (mm):	810
Width (mm):	530
Depth (mm):	480
Gross Weight (kg):	32

### Packaging Data

Box Colour:	Brown Cardboard Box - Printed
Box Qty:	1
Label Size:	100 x 50
Label Colour:	White Label
Label Qty:	2

### Outer Box Dimensions (If Applicable)

Height (mm):	
Width (mm):	
Depth (mm):	
Gross Weight (kg):	
Barcode:	5055275811498

### Product Details

Country of Origin:	China
Fitting Instruction:	No
CE & UKCA:	N/A
FSC Certified Materials:	Yes
Colour:	Gloss White
Construction Method:	Cam & Wood Dowel
Construction Type:	Rigid
Cabinet Finish:	MFC Smooth Matt
Fascia Finish:	Mdf Painted Gloss
Cabinet Thickness (mm):	18
Fascia Thickness (mm):	18
Drawer Included:	Yes
Drawer Type:	80mm High Metal S/C Inc Galler
No of Shelves:	0
Hinge Type:	Not Applicable
Hinge Included:	No
Adjustable Legs:	No
Fixings Included:	Yes
Handle Style:	Contemporary
Waste Shroud:	Yes
Handle Included:	Yes
Handle Type:	Cup

Sales Code: PMB005

Description: 800X450mm Poly Marble Basin



### Product Dimensions

Height (mm):	450
Width (mm):	800
Depth (mm):	157
Nett Weight (kg):	18.12

### Packaging Dimensions

Height (mm):	167
Width (mm):	840
Depth (mm):	470
Gross Weight (kg):	18.12

### Packaging Data

Box Colour:	Brown Cardboard Box - Printed
Box Qty:	1
Label Size:	100 x 50
Label Colour:	White Label
Label Qty:	2

### Outer Box Dimensions (If Applicable)

Height (mm):	
Width (mm):	
Depth (mm):	
Gross Weight (kg):	
Barcode:	5055369021765

### Product Details

Country of Origin:	China
Fitting Instruction:	No
Certification: CE & UKCA:	No WRAS: N/A WRAS No: N/A
Product Material:	Polymarble
Fixing Supplied:	No

**Pans/Bidets:** Trap Style: Not Applicable Includes Seat: Not Applicable

**Seats:** Seat Type: Not Applicable Material: Not Applicable  
Function: Not Applicable Hinge Type: Not Applicable  
Hinge Material: Not Applicable

**Cisterns:** Operating Type: Not Applicable Fittings: Not Applicable  
Lever Type: Not Applicable

**Basins:** Tap Hole: One Taphole Chain Stay Hole: No  
Template: Not Required Waste Type Req: Slotted  
Overflow Inc: Yes Overflow Cover: Yes  
Inner Bowl Depth (mm): 105mm

**Sales Code:** FPA005A

**Description:** Parade 800 W/H 2 Drawer Unit & Basin

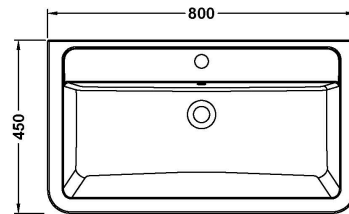
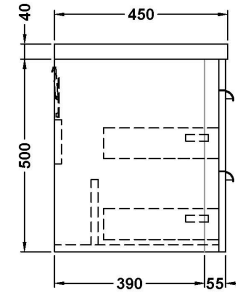
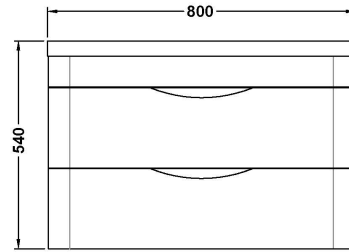

### Packaging Details

Barcode: 5056211888468

Sales Code: CBM005

Description: Ceramic Basin 800X450

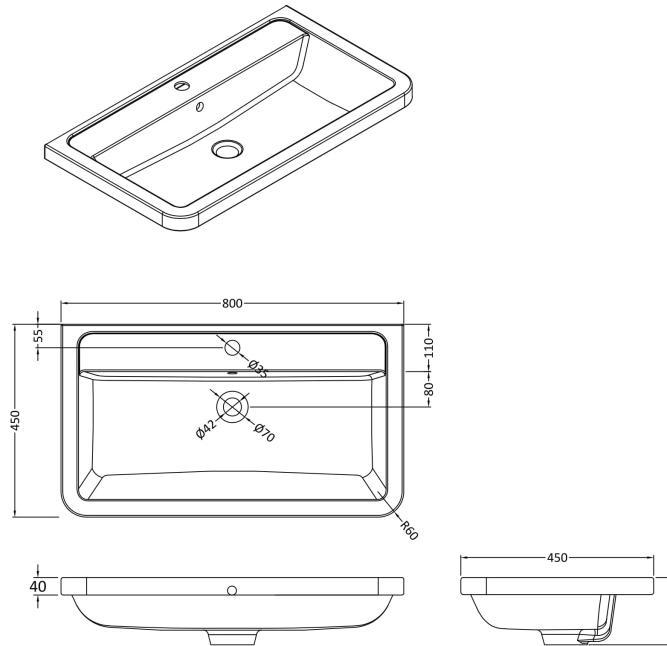

### Product Dimensions

Height (mm):	450
Width (mm):	800
Depth (mm):	157
Nett Weight (kg):	18.12

### Packaging Dimensions

Height (mm):	470
Width (mm):	840
Depth (mm):	167
Gross Weight (kg):	18.12

### Packaging Data

Box Colour:	Brown Cardboard Box - Printed
Box Qty:	1
Label Size:	100 x 50
Label Colour:	White Label
Label Qty:	2

### Outer Box Dimensions (If Applicable)

Height (mm):	
Width (mm):	
Depth (mm):	
Gross Weight (kg):	
Barcode:	5056211875802

### Product Details

Country of Origin:	China
Fitting Instruction:	No
Certification: CE & UKCA: No	WRAS: N/A WRAS No: N/A
Product Material:	Vitreous China
Fixing Supplied:	No

**Pans/Bidets:** Trap Style: Not Applicable Includes Seat: Not Applicable

**Seats:** Seat Type: Not Applicable Material: Not Applicable  
Function: Not Applicable Hinge Type: Not Applicable  
Hinge Material: Not Applicable

**Cisterns:** Operating Type: Not Applicable Fittings: Not Applicable  
Lever Type: Not Applicable

**Basins:** Tap Hole: One Taphole Chain Stay Hole: No  
Template: Not Required Waste Type Req: Slotted  
Overflow Inc: Yes Overflow Cover: Yes  
Inner Bowl Depth (mm): 105mm

**Sales Code:** PMP185

**Description:** 800 Wall Hung 2-Drawer Basin Unit

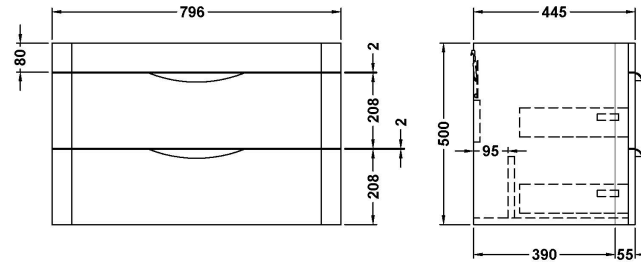

### Product Dimensions

Height (mm):	500
Width (mm):	796
Depth (mm):	445
Nett Weight (kg):	32

### Packaging Dimensions

Height (mm):	810
Width (mm):	530
Depth (mm):	480
Gross Weight (kg):	32

### Packaging Data

Box Colour:	Brown Cardboard Box - Printed
Box Qty:	1
Label Size:	100 x 50
Label Colour:	White Label
Label Qty:	2

### Outer Box Dimensions (If Applicable)

Height (mm):	
Width (mm):	
Depth (mm):	
Gross Weight (kg):	
Barcode:	5055275811498

### Product Details

Country of Origin:	China
Fitting Instruction:	No
CE & UKCA:	N/A
FSC Certified Materials:	Yes
Colour:	Gloss White
Construction Method:	Cam & Wood Dowel
Construction Type:	Rigid
Cabinet Finish:	MFC Smooth Matt
Fascia Finish:	Mdf Painted Gloss
Cabinet Thickness (mm):	18
Fascia Thickness (mm):	18
Drawer Included:	Yes
Drawer Type:	80mm High Metal S/C Inc Galler
No of Shelves:	0
Hinge Type:	Not Applicable
Hinge Included:	No
Adjustable Legs:	No
Fixings Included:	Yes
Handle Style:	Contemporary
Waste Shroud:	Yes
Handle Included:	Yes
Handle Type:	Cup