

**Washbasin # 2319550000**

| &lt; 550 mm &gt; |

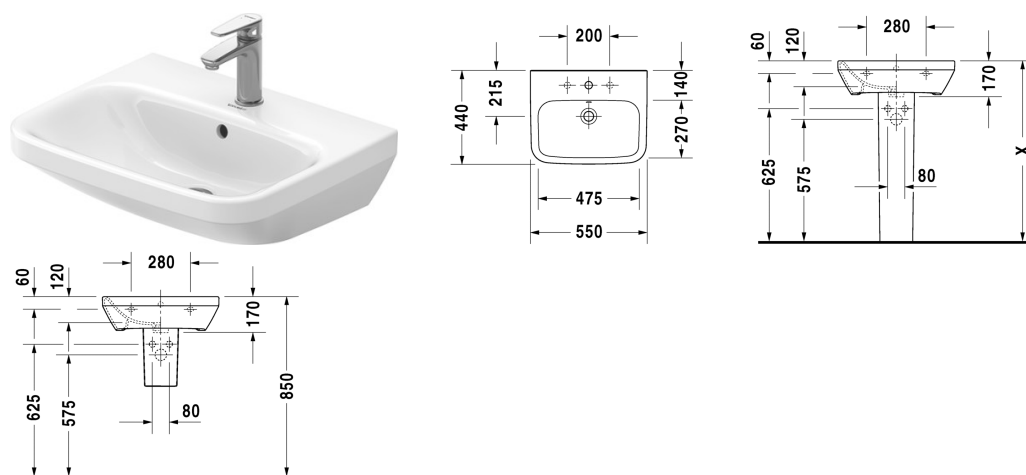

Washbasin	Dimension	Weight	Order number
with overflow, with tap platform, underneath glazed, 550 mm			
<b>Colors</b>			
00 White Alpin			
<b>Variant</b>			
●	550 x 440 mm	15.800 kg	2319550000
Sanitary ceramics with the special WonderGliss surface finish will remain clean and attractive-looking for a long time to come. When ordering WonderGliss please add a "1" as eleventh digit to the model number.			
<b>Suitable products</b>			
Semi pedestal for # 231955, 231960, 231965, 232012, 232010, 232080, 232065, 233813, 232460,			085830
Pedestal for # 231955, 231960, 231965, 232012, 232010, 232080, 232065, 233813, 232460,			085829
<b>Recommended faucets</b>			
Single lever basin mixer M Ceramic cartridge, Projection 139 mm, Flexible connection hoses 3/8 ", aerator adjustable, Normal spray, chrome, maximum temperature can be adjusted on installation, recommended operating pressure 3 - 5 bar, with pop-up waste set,			B11020001

**Washbasin # 2319600000**

| &lt; 600 mm &gt; |

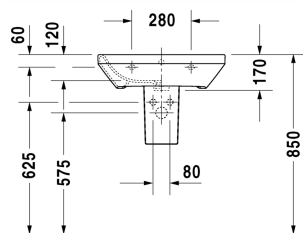
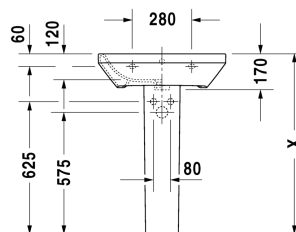
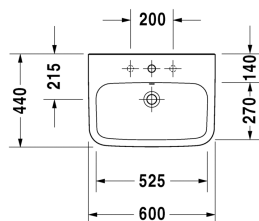

Washbasin	Dimension	Weight	Order number
with overflow, with tap platform, underneath glazed, 600 mm			
<b>Colors</b>			
00 White Alpin			
<b>Variant</b>			
●	600 x 440 mm	17.000 kg	2319600000
Sanitary ceramics with the special WonderGliss surface finish will remain clean and attractive-looking for a long time to come. When ordering WonderGliss please add a "1" as eleventh digit to the model number.			
<b>Suitable products</b>			
Semi pedestal for # 231955, 231960, 231965, 232012, 232010, 232080, 232065, 233813, 232460,			085830
Pedestal for # 231955, 231960, 231965, 232012, 232010, 232080, 232065, 233813, 232460,			085829
<b>Recommended faucets</b>			
Single lever basin mixer M Ceramic cartridge, Projection 139 mm, Flexible connection hoses 3/8 ",, aerator adjustable, Normal spray, chrome, maximum temperature can be adjusted on installation, recommended operating pressure 3 - 5 bar, with pop-up waste set,			B11020001

Single lever basin mixer M Ceramic cartridge, Projection 139 mm, Flexible connection hoses 3/8 ", aerator adjustable, Normal spray, chrome, maximum temperature can be adjusted on installation, recommended operating pressure 3 - 5 bar, with pop-up waste set,	B21020001
Single lever basin mixer M Ceramic cartridge, Projection 139 mm, Flexible connection hoses 3/8 ", aerator adjustable, Normal spray, chrome, maximum temperature can be adjusted on installation, recommended operating pressure 3 - 5 bar, without pop-up waste set,	B11020002
Single lever basin mixer M Ceramic cartridge, Projection 139 mm, Flexible connection hoses 3/8 ", aerator adjustable, Normal spray, chrome, maximum temperature can be adjusted on installation, recommended operating pressure 3 - 5 bar, without pop-up waste set,	B21020002
Single lever basin mixer M Ceramic cartridge, Projection 109 mm, Flexible connection hoses 3/8 ", aerator adjustable, Normal spray, chrome, maximum temperature can be adjusted on installation, recommended operating pressure 3 - 5 bar, with pop-up waste set,	DE1020001
Single lever basin mixer M Ceramic cartridge, Projection 109 mm, Flexible connection hoses 3/8 ", aerator adjustable, Normal spray, chrome, maximum temperature can be adjusted on installation, recommended operating pressure 3 - 5 bar, without pop-up waste set,	DE1020002
Single lever basin mixer M FreshStart Ceramic cartridge, in centre position cold water, Projection 109 mm, Flexible connection hoses 3/8 ", aerator adjustable, Normal spray, chrome, maximum temperature can be adjusted on installation, recommended operating pressure 3 - 5 bar, with pop-up waste set,	DE1021001
Single lever basin mixer M FreshStart Ceramic cartridge, in centre position cold water, Projection 109 mm, Flexible connection hoses 3/8 ", aerator adjustable, Normal spray, chrome, maximum temperature can be adjusted on installation, recommended operating pressure 3 - 5 bar, without pop-up waste set,	DE1021002
Single lever basin mixer M Ceramic cartridge, projection 106 mm, Flexible connection hoses 3/8 ", Normal spray, flow rate 5,0 l/min (3 bar), connection size DN15, chrome, recommended operating pressure 3 - 5 bar, with pop-up waste set,	N11020001
Single lever basin mixer M Ceramic cartridge, projection 106 mm, Flexible connection hoses 3/8 ", Normal spray, flow rate 5,0 l/min (3 bar), connection size DN15, chrome, recommended operating pressure 3 - 5 bar, without pop-up waste set,	N11020002
Single lever basin mixer M FreshStart Ceramic cartridge, in centre position cold water, projection 106 mm, Flexible connection hoses 3/8 ", Normal spray, flow rate 5,0 l/min (3 bar), connection size DN15, chrome, recommended operating pressure 3 - 5 bar, with pop-up waste set,	N11021001
Single lever basin mixer M FreshStart Ceramic cartridge, in centre position cold water, projection 106 mm, Flexible connection hoses 3/8 ", Normal spray, flow rate 5,0 l/min (3 bar), connection size DN15, chrome, recommended operating pressure 3 - 5 bar, without pop-up waste set,	N11021002

Washbasin # 2319600000

|< 600 mm >|

Single lever basin mixer M MinusFlow Ceramic cartridge, projection 106 mm, Flexible connection hoses 3/8 ", Normal spray, flow rate 3,5 l/min (3 bar), connection size DN15, chrome, recommended operating pressure 3 - 5 bar, with pop-up waste set,	N11022001
Single lever basin mixer M MinusFlow Ceramic cartridge, projection 106 mm, Flexible connection hoses 3/8 ", Normal spray, flow rate 3,5 l/min (3 bar), connection size DN15, chrome, recommended operating pressure 3 - 5 bar, without pop-up waste set,	N11022002
Single lever basin mixer M Ceramic cartridge, projection 122 mm, aerator with Easy-clean spray-plate, flow rate 5,0 l/min (3 bar), Normal spray, connection size DN15, recommended operating pressure 3 - 5 bar, with pop-up waste set,	WA1020001
Single lever basin mixer M Ceramic cartridge, projection 122 mm, aerator with Easy-clean spray-plate, flow rate 5,0 l/min (3 bar), Normal spray, connection size DN15, recommended operating pressure 3 - 5 bar, without pop-up waste set,	WA1020002
Single lever basin mixer M FreshStart connection size DN15,	WA1021001
Single lever basin mixer M FreshStart connection size DN15,	WA1021002
Single lever basin mixer M MinusFlow connection size DN15,	WA1022001
Single lever basin mixer M MinusFlow connection size DN15,	WA1022002

*All drawings contain the necessary measurements which are subject to standard tolerances. They are stated in mm and are non-binding. Exact measurements, in particular for customised installation scenarios, can only be taken from the finished piece.*

Washbasin # 2319650000

| < 650 mm > |

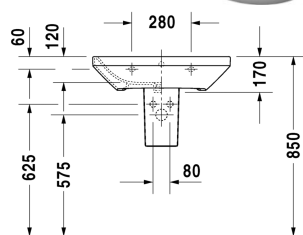
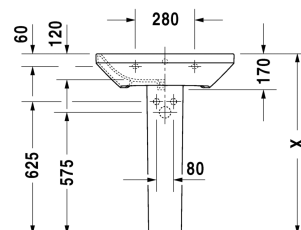
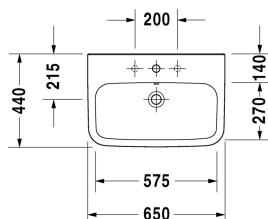

Washbasin	Dimension	Weight	Order number
with overflow, with tap platform, underneath glazed, 650 mm			
<b>Colors</b>			
00 White Alpin			
<b>Variant</b>			
●	650 x 440 mm	18.400 kg	2319650000
Sanitary ceramics with the special WonderGliss surface finish will remain clean and attractive-looking for a long time to come. When ordering WonderGliss please add a "1" as eleventh digit to the model number.			
<b>Suitable products</b>			
Semi pedestal for # 231955, 231960, 231965, 232012, 232010, 232080, 232065, 233813, 232460,			085830
Pedestal for # 231955, 231960, 231965, 232012, 232010, 232080, 232065, 233813, 232460,			085829
<b>Recommended faucets</b>			
Single lever basin mixer M Ceramic cartridge, Projection 139 mm, Flexible connection hoses 3/8 ",, aerator adjustable, Normal spray, chrome, maximum temperature can be adjusted on installation, recommended operating pressure 3 - 5 bar, with pop-up waste set,			B11020001

Single lever basin mixer M Ceramic cartridge, Projection 139 mm, Flexible connection hoses 3/8 ", aerator adjustable, Normal spray, chrome, maximum temperature can be adjusted on installation, recommended operating pressure 3 - 5 bar, with pop-up waste set,	B21020001
Single lever basin mixer M Ceramic cartridge, Projection 139 mm, Flexible connection hoses 3/8 ", aerator adjustable, Normal spray, chrome, maximum temperature can be adjusted on installation, recommended operating pressure 3 - 5 bar, without pop-up waste set,	B11020002
Single lever basin mixer M Ceramic cartridge, Projection 139 mm, Flexible connection hoses 3/8 ", aerator adjustable, Normal spray, chrome, maximum temperature can be adjusted on installation, recommended operating pressure 3 - 5 bar, without pop-up waste set,	B21020002
Single lever basin mixer M Ceramic cartridge, Projection 109 mm, Flexible connection hoses 3/8 ", aerator adjustable, Normal spray, chrome, maximum temperature can be adjusted on installation, recommended operating pressure 3 - 5 bar, with pop-up waste set,	DE1020001
Single lever basin mixer M Ceramic cartridge, Projection 109 mm, Flexible connection hoses 3/8 ", aerator adjustable, Normal spray, chrome, maximum temperature can be adjusted on installation, recommended operating pressure 3 - 5 bar, without pop-up waste set,	DE1020002
Single lever basin mixer M FreshStart Ceramic cartridge, in centre position cold water, Projection 109 mm, Flexible connection hoses 3/8 ", aerator adjustable, Normal spray, chrome, maximum temperature can be adjusted on installation, recommended operating pressure 3 - 5 bar, with pop-up waste set,	DE1021001
Single lever basin mixer M FreshStart Ceramic cartridge, in centre position cold water, Projection 109 mm, Flexible connection hoses 3/8 ", aerator adjustable, Normal spray, chrome, maximum temperature can be adjusted on installation, recommended operating pressure 3 - 5 bar, without pop-up waste set,	DE1021002
Single lever basin mixer M Ceramic cartridge, projection 106 mm, Flexible connection hoses 3/8 ", Normal spray, flow rate 5,0 l/min (3 bar), connection size DN15, chrome, recommended operating pressure 3 - 5 bar, with pop-up waste set,	N11020001
Single lever basin mixer M Ceramic cartridge, projection 106 mm, Flexible connection hoses 3/8 ", Normal spray, flow rate 5,0 l/min (3 bar), connection size DN15, chrome, recommended operating pressure 3 - 5 bar, without pop-up waste set,	N11020002
Single lever basin mixer M FreshStart Ceramic cartridge, in centre position cold water, projection 106 mm, Flexible connection hoses 3/8 ", Normal spray, flow rate 5,0 l/min (3 bar), connection size DN15, chrome, recommended operating pressure 3 - 5 bar, with pop-up waste set,	N11021001
Single lever basin mixer M FreshStart Ceramic cartridge, in centre position cold water, projection 106 mm, Flexible connection hoses 3/8 ", Normal spray, flow rate 5,0 l/min (3 bar), connection size DN15, chrome, recommended operating pressure 3 - 5 bar, without pop-up waste set,	N11021002

Washbasin # 2319650000

|< 650 mm >|

Single lever basin mixer M MinusFlow Ceramic cartridge, projection 106 mm, Flexible connection hoses 3/8 ", Normal spray, flow rate 3,5 l/min (3 bar), connection size DN15, chrome, recommended operating pressure 3 - 5 bar, with pop-up waste set,	N11022001
Single lever basin mixer M MinusFlow Ceramic cartridge, projection 106 mm, Flexible connection hoses 3/8 ", Normal spray, flow rate 3,5 l/min (3 bar), connection size DN15, chrome, recommended operating pressure 3 - 5 bar, without pop-up waste set,	N11022002
Single lever basin mixer M Ceramic cartridge, projection 122 mm, aerator with Easy-clean spray-plate, flow rate 5,0 l/min (3 bar), Normal spray, connection size DN15, recommended operating pressure 3 - 5 bar, with pop-up waste set,	WA1020001
Single lever basin mixer M Ceramic cartridge, projection 122 mm, aerator with Easy-clean spray-plate, flow rate 5,0 l/min (3 bar), Normal spray, connection size DN15, recommended operating pressure 3 - 5 bar, without pop-up waste set,	WA1020002
Single lever basin mixer M FreshStart connection size DN15,	WA1021001
Single lever basin mixer M FreshStart connection size DN15,	WA1021002
Single lever basin mixer M MinusFlow connection size DN15,	WA1022001
Single lever basin mixer M MinusFlow connection size DN15,	WA1022002

*All drawings contain the necessary measurements which are subject to standard tolerances. They are stated in mm and are non-binding. Exact measurements, in particular for customised installation scenarios, can only be taken from the finished piece.*

Single lever basin mixer M Ceramic cartridge, Projection 139 mm, Flexible connection hoses 3/8 ", aerator adjustable, Normal spray, chrome, maximum temperature can be adjusted on installation, recommended operating pressure 3 - 5 bar, with pop-up waste set,	B21020001
Single lever basin mixer M Ceramic cartridge, Projection 139 mm, Flexible connection hoses 3/8 ", aerator adjustable, Normal spray, chrome, maximum temperature can be adjusted on installation, recommended operating pressure 3 - 5 bar, without pop-up waste set,	B11020002
Single lever basin mixer M Ceramic cartridge, Projection 139 mm, Flexible connection hoses 3/8 ", aerator adjustable, Normal spray, chrome, maximum temperature can be adjusted on installation, recommended operating pressure 3 - 5 bar, without pop-up waste set,	B21020002
Single lever basin mixer M Ceramic cartridge, Projection 109 mm, Flexible connection hoses 3/8 ", aerator adjustable, Normal spray, chrome, maximum temperature can be adjusted on installation, recommended operating pressure 3 - 5 bar, with pop-up waste set,	DE1020001
Single lever basin mixer M Ceramic cartridge, Projection 109 mm, Flexible connection hoses 3/8 ", aerator adjustable, Normal spray, chrome, maximum temperature can be adjusted on installation, recommended operating pressure 3 - 5 bar, without pop-up waste set,	DE1020002
Single lever basin mixer M FreshStart Ceramic cartridge, in centre position cold water, Projection 109 mm, Flexible connection hoses 3/8 ", aerator adjustable, Normal spray, chrome, maximum temperature can be adjusted on installation, recommended operating pressure 3 - 5 bar, with pop-up waste set,	DE1021001
Single lever basin mixer M FreshStart Ceramic cartridge, in centre position cold water, Projection 109 mm, Flexible connection hoses 3/8 ", aerator adjustable, Normal spray, chrome, maximum temperature can be adjusted on installation, recommended operating pressure 3 - 5 bar, without pop-up waste set,	DE1021002
Single lever basin mixer M Ceramic cartridge, projection 106 mm, Flexible connection hoses 3/8 ", Normal spray, flow rate 5,0 l/min (3 bar), connection size DN15, chrome, recommended operating pressure 3 - 5 bar, with pop-up waste set,	N11020001
Single lever basin mixer M Ceramic cartridge, projection 106 mm, Flexible connection hoses 3/8 ", Normal spray, flow rate 5,0 l/min (3 bar), connection size DN15, chrome, recommended operating pressure 3 - 5 bar, without pop-up waste set,	N11020002
Single lever basin mixer M FreshStart Ceramic cartridge, in centre position cold water, projection 106 mm, Flexible connection hoses 3/8 ", Normal spray, flow rate 5,0 l/min (3 bar), connection size DN15, chrome, recommended operating pressure 3 - 5 bar, with pop-up waste set,	N11021001
Single lever basin mixer M FreshStart Ceramic cartridge, in centre position cold water, projection 106 mm, Flexible connection hoses 3/8 ", Normal spray, flow rate 5,0 l/min (3 bar), connection size DN15, chrome, recommended operating pressure 3 - 5 bar, without pop-up waste set,	N11021002



Washbasin # 2319550000

|< 550 mm >|

Single lever basin mixer M MinusFlow Ceramic cartridge, projection 106 mm, Flexible connection hoses 3/8 ", Normal spray, flow rate 3,5 l/min (3 bar), connection size DN15, chrome, recommended operating pressure 3 - 5 bar, with pop-up waste set,	N11022001
Single lever basin mixer M MinusFlow Ceramic cartridge, projection 106 mm, Flexible connection hoses 3/8 ", Normal spray, flow rate 3,5 l/min (3 bar), connection size DN15, chrome, recommended operating pressure 3 - 5 bar, without pop-up waste set,	N11022002
Single lever basin mixer M Ceramic cartridge, projection 122 mm, aerator with Easy-clean spray-plate, flow rate 5,0 l/min (3 bar), Normal spray, connection size DN15, recommended operating pressure 3 - 5 bar, with pop-up waste set,	WA1020001
Single lever basin mixer M Ceramic cartridge, projection 122 mm, aerator with Easy-clean spray-plate, flow rate 5,0 l/min (3 bar), Normal spray, connection size DN15, recommended operating pressure 3 - 5 bar, without pop-up waste set,	WA1020002
Single lever basin mixer M FreshStart connection size DN15,	WA1021001
Single lever basin mixer M FreshStart connection size DN15,	WA1021002
Single lever basin mixer M MinusFlow connection size DN15,	WA1022001
Single lever basin mixer M MinusFlow connection size DN15,	WA1022002

*All drawings contain the necessary measurements which are subject to standard tolerances. They are stated in mm and are non-binding. Exact measurements, in particular for customised installation scenarios, can only be taken from the finished piece.*