

Mira Mode

Shower Fittings & User Interface



1.1980.001	Mira Mode Rear Fed Shower (High Pressure / Combi)
1.1980.002	Mira Mode Rear Fed Shower (Pumped)
1.1980.003	Mira Mode Ceiling Fed Shower (High Pressure / Combi)
1.1980.004	Mira Mode Ceiling Fed Shower (Pumped)
1.1980.005	Mira Mode Dual Rear Fed Shower (High Pressure / Combi)
1.1980.006	Mira Mode Dual Rear Fed Shower (Pumped)
1.1980.007	Mira Mode Dual Ceiling Fed Shower (High Pressure / Combi)

1.1980.008	Mira Mode Dual Ceiling Fed Shower (Pumped)
1.1980.009	Mira Mode Bath (High Pressure / Combi)
1.1980.010	Mira Mode Bath (Pumped)
1.1980.011	Mira Mode Dual Bath / Shower (High Pressure / Combi)
1.1980.012	Mira Mode Dual Bath / Shower (Pumped)
1.1980.013	Mira Mode Maxim Rear Fed (High Pressure)
1.1980.014	Mira Mode Maxim Rear Fed (Pumped)
1.1980.015	Mira Mode Maxim Ceiling Fed (High Pressure)
1.1980.016	Mira Mode Maxim Ceiling Fed (Pumped)

User Interface

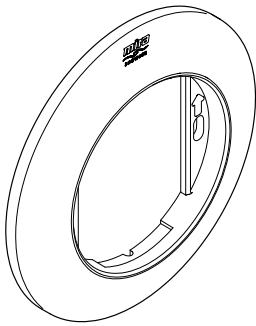

1874.274
Backplate (x1)

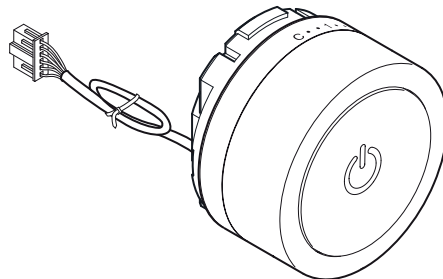

GP1527806W-CP
Shower Interface

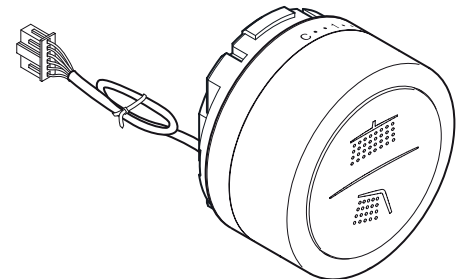

GP1527807W-CP
Dual Shower Interface

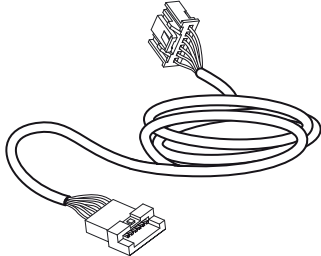

1874.277
Interface Lead

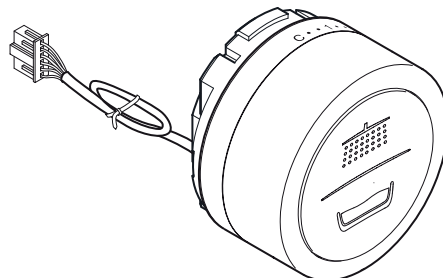

GP1527809W-CP
Dual Shower/Bath Fill Interface

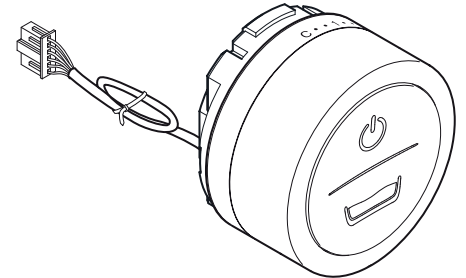

GP1527808-CP
Bath Fill Shower Interface

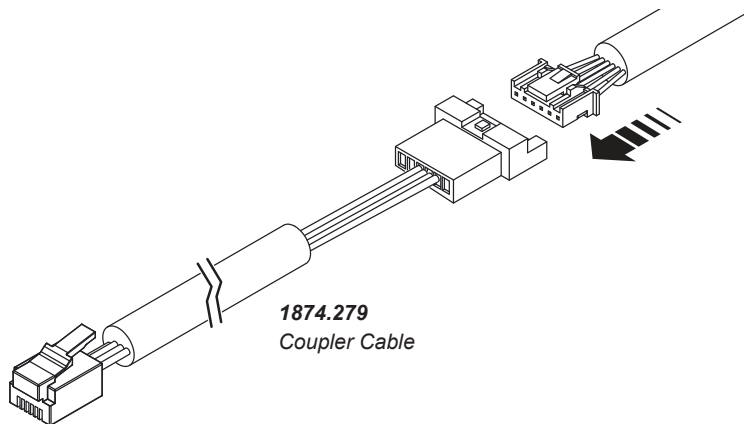

1874.279
Coupler Cable

Mira Digital mixing showers are provided with five years warranty and fittings with a one year warranty. Spare parts are available free of charge during that period with a valid proof of purchase. For showers outside of the warranty period, spare parts are available to purchase direct, alternatively we have Mira technicians who can repair your shower for you. For further information visit www.mirashowers.co.uk or to check availability of spare parts for this shower or enquire about our repair service please contact our customer service on 0800 001 4040.

1512169-W8-A



Mira Mode

Ceiling Fed Shower Fitting



1.1980.003	Mira Mode Ceiling Fed Shower (High Pressure / Combi)
1.1980.004	Mira Mode Ceiling Fed Shower (Pumped)
1.1980.007	Mira Mode Dual Ceiling Fed Shower (High Pressure / Combi)

1.1980.008	Mira Mode Dual Ceiling Fed Shower (Pumped)
1.1980.015	Mira Mode Maxim Ceiling Fed (High Pressure)
1.1980.016	Mira Mode Maxim Ceiling Fed (Pumped)

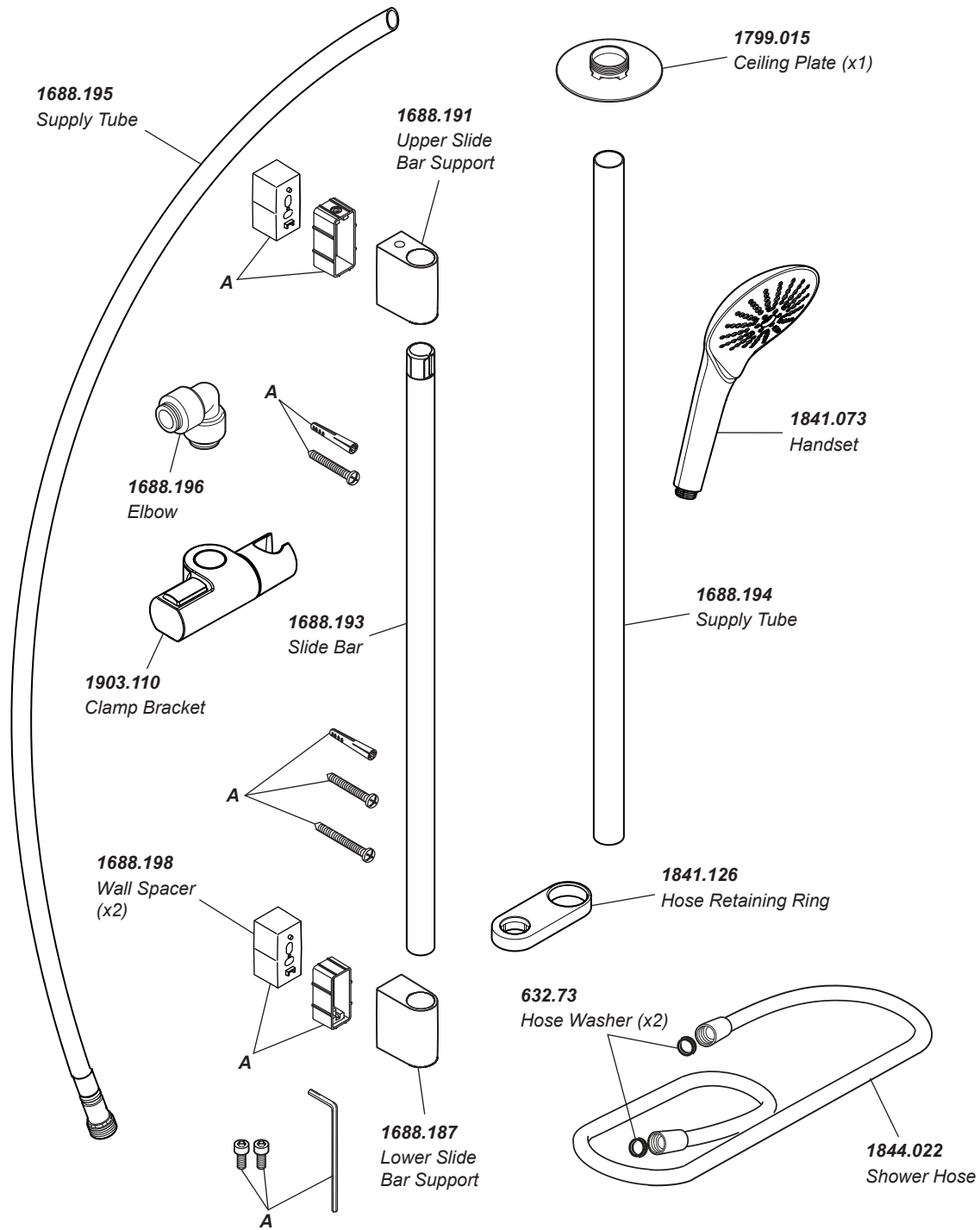

1688.184 Seal and Screw Pack - not illustrated
1688.190 Classic Fittings Component Pack Chrome - Components identified 'A'

Mira Digital mixing showers are provided with five years warranty and fittings with a one year warranty. Spare parts are available free of charge during that period with a valid proof of purchase. For showers outside of the warranty period, spare parts are available to purchase direct, alternatively we have Mira technicians who can repair your shower for you. For further information visit www.mirashowers.co.uk or to check availability of spare parts for this shower or enquire about our repair service please contact our customer service on 0800 001 4040.



Mira Mode

Rear Fed Shower Fitting



1.1980.001	Mira Mode Rear Fed Shower (High Pressure / Combi)
1.1980.002	Mira Mode Rear Fed Shower (Pumped)
1.1980.005	Mira Mode Dual Rear Fed Shower (High Pressure / Combi)
1.1980.006	Mira Mode Dual Rear Fed Shower (Pumped)

1.1980.011	Mira Mode Dual Bath / Shower (High Pressure / Combi)
1.1980.012	Mira Mode Dual Bath / Shower (Pumped)
1.1980.013	Mira Mode Maxim Rear Fed (High Pressure)
1.1980.014	Mira Mode Maxim Rear Fed (Pumped)

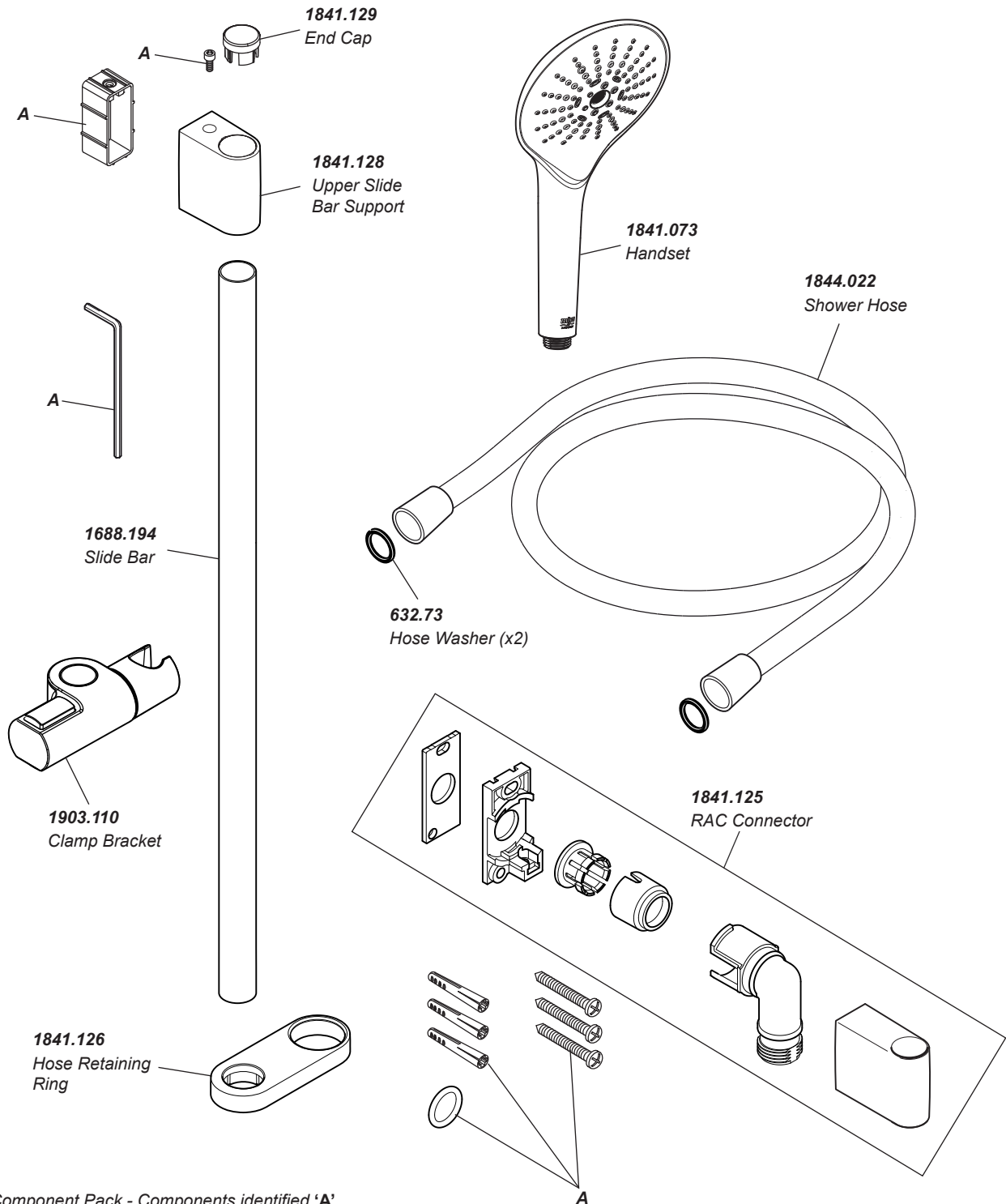

1841.130 Component Pack - Components identified 'A'

Mira Digital mixing showers are provided with five years warranty and fittings with a one year warranty. Spare parts are available free of charge during that period with a valid proof of purchase. For showers outside of the warranty period, spare parts are available to purchase direct, alternatively we have Mira technicians who can repair your shower for you. For further information visit www.mirashowers.co.uk or to check availability of spare parts for this shower or enquire about our repair service please contact our customer service on 0800 001 4040.

1512169-W8-A



Mira Mode

Ceiling-Fed Deluge Head



1.1980.007	Mira Mode Dual Ceiling Fed Shower (High Pressure / Combi)
1.1980.008	Mira Mode Dual Ceiling Fed Shower (Pumped)

1.1980.015	Mira Mode Maxim Ceiling Fed (High Pressure)
1.1980.016	Mira Mode Maxim Ceiling Fed (Pumped)

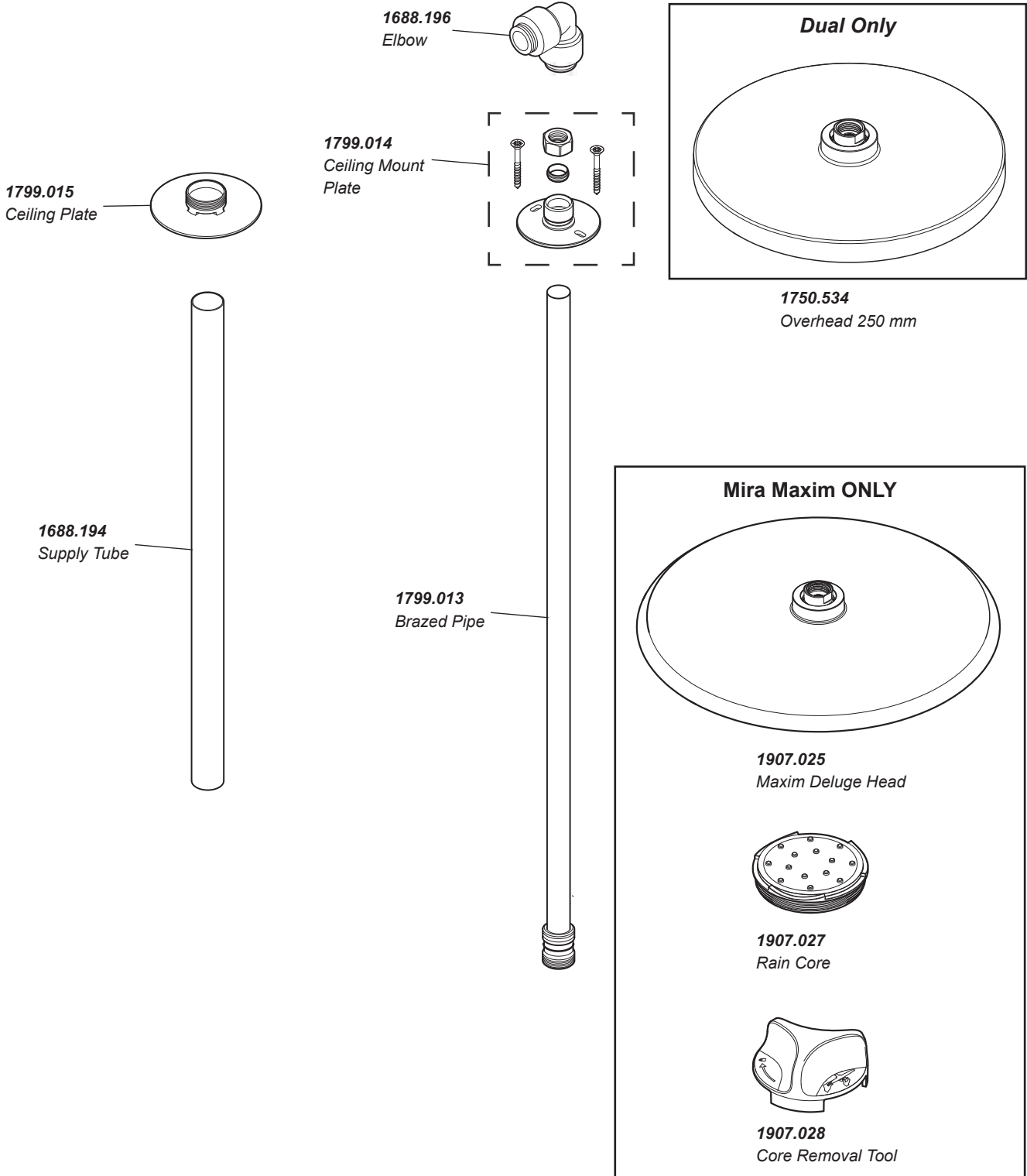

Mira Digital mixing showers are provided with five years warranty and fittings with a one year warranty. Spare parts are available free of charge during that period with a valid proof of purchase. For showers outside of the warranty period, spare parts are available to purchase direct, alternatively we have Mira technicians who can repair your shower for you. For further information visit www.mirashowers.co.uk or to check availability of spare parts for this shower or enquire about our repair service please contact our customer service on 0800 001 4040.

1512169-W8-A



Mira Mode

Rear Fed Shower Arm, Deluge Head



1.1980.005	Mira Mode Dual Rear Fed Shower (High Pressure / Combi)
1.1980.006	Mira Mode Dual Rear Fed Shower (Pumped)

1.1980.013	Mira Mode Maxim Rear Fed (High Pressure)
1.1980.014	Mira Mode Maxim Rear Fed (Pumped)

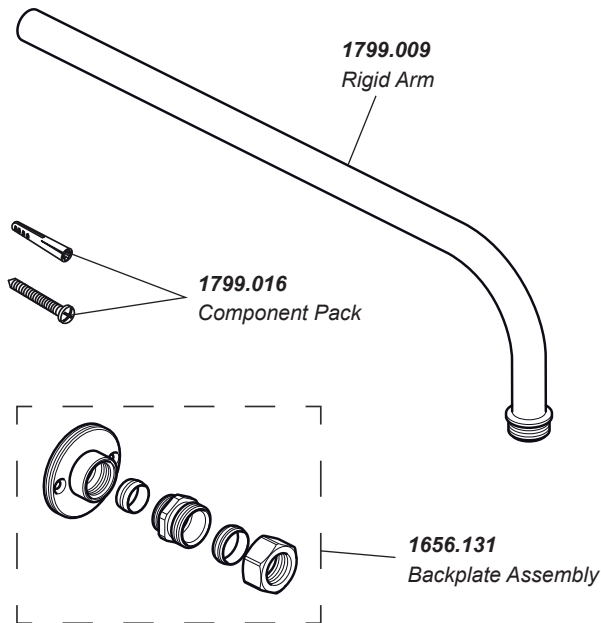

1874.288 Flow Regulator Component Pack - not illustrated

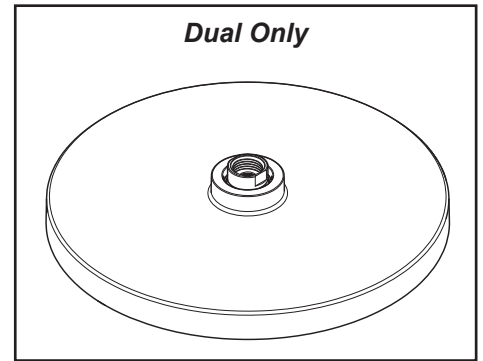
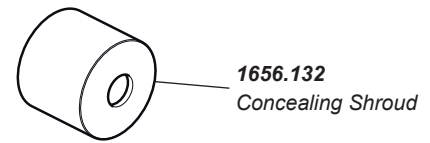

1750.534
Overhead 250 mm

Bath Filler

1.1980.009	Mira Mode Bath (High Pressure / Combi)
1.1980.010	Mira Mode Bath (Pumped)
1.1980.011	Mira Mode Dual Bath / Shower (High Pressure / Combi)
1.1980.012	Mira Mode Dual Bath / Shower (Pumped)

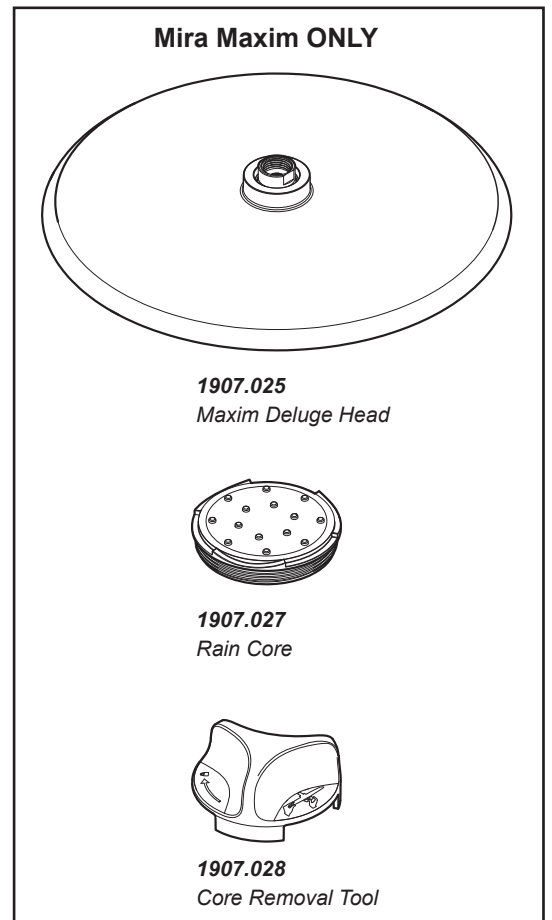
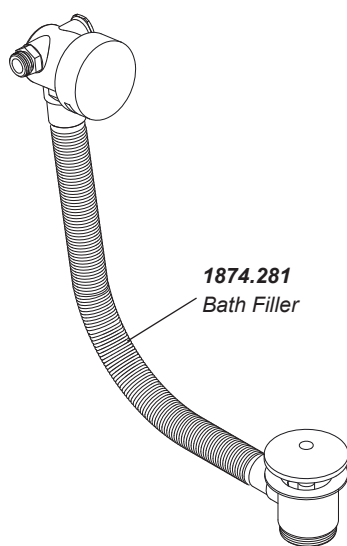

Mira Digital mixing showers are provided with five years warranty and fittings with a one year warranty. Spare parts are available free of charge during that period with a valid proof of purchase. For showers outside of the warranty period, spare parts are available to purchase direct, alternatively we have Mira technicians who can repair your shower for you. For further information visit www.mirashowers.co.uk or to check availability of spare parts for this shower or enquire about our repair service please contact our customer service on 0800 001 4040.

1512169-W8-A

