

Sales Code: DOCMP001

Description: Doc M Pack White

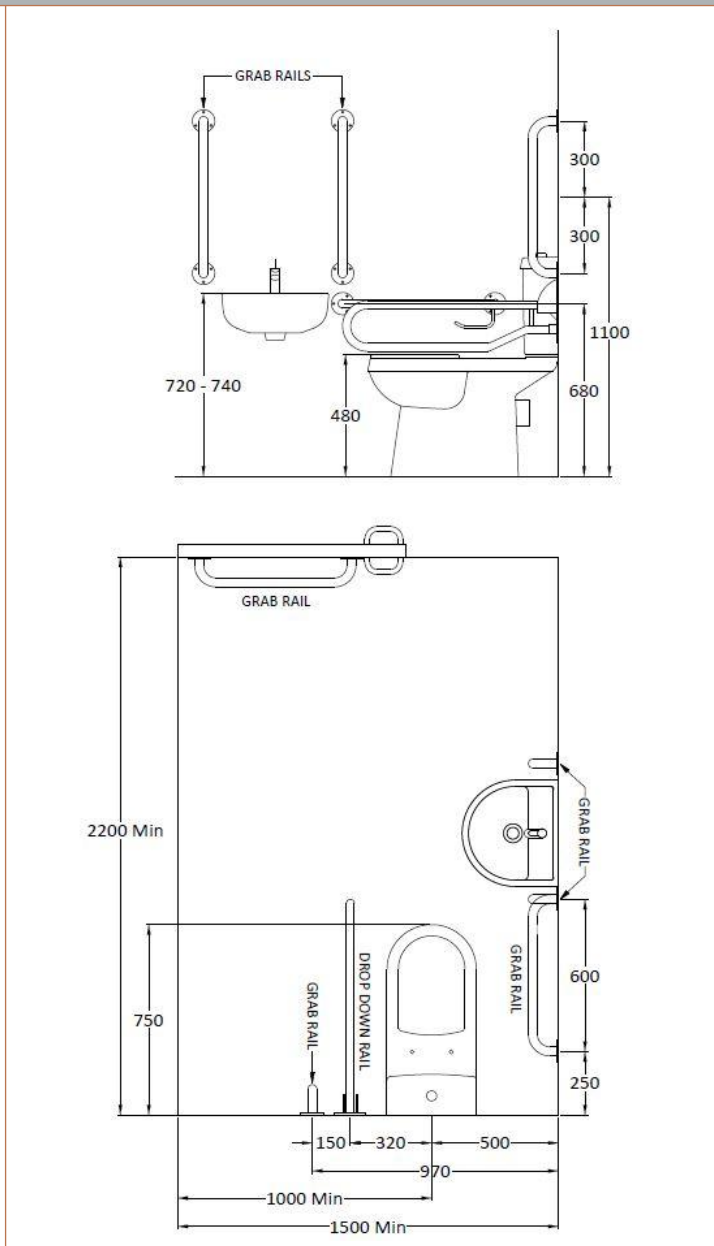

Product Dimensions

Height (mm):	0
Width (mm):	0
Depth (mm):	0
Nett Weight (kg):	64.5

Packaging Dimensions

Height (mm):	660
Width (mm):	620
Depth (mm):	890
Gross Weight (kg):	64.5

Packaging Data

Box Colour:	Brown Cardboard Box - Printed
Box Qty:	0
Label Size:	0 x 0
Label Colour:	White Label
Label Qty:	0

Outer Box Dimensions (If Applicable)

Height (mm):	
Width (mm):	
Depth (mm):	
Gross Weight (kg):	
Barcode:	5055369028399

Product Details

Country of Origin:	China
Fitting Instruction:	No
Certification: CE & UKCA:	No
WRAS:	N/A
WRAS No:	N/A
Product Material:	Vitreous China
Fixing Supplied:	No

Pans/Bidets: Trap Style: P Trap Includes Seat: Yes

Seats: Seat Type: Round Material: Polypropylene
Function: Std - Non Soft Close Hinge Type: Bottom Fix
Hinge Material: Plastic

Cisterns: Operating Type: Push Button Fittings: Loose Single 6L
Lever Type: Plastic Chrome Plate

Basins: Tap Hole: One Taphole Chain Stay Hole: No
Template: Not Required Waste Type Req: Slotted
Overflow Inc: Yes Overflow Cover: No
Inner Bowl Depth (mm): 150mm