

**thermo**  
Sphere

**HEATING** | WALL  
TOWEL BARS

ThermoSphere 12V DE Towel  
Bar Installation Guide



Watch the video!



Live **well...**

## Warranty terms & conditions

ThermoSphere covers all its products with a satisfaction guarantee. In addition, ThermoSphere will supply a replacement product where a fault is shown to be caused by manufacture, materials or workmanship providing the goods have been installed correctly and according to installation instructions. This guarantee does not include removal, freight or installation costs.

To use the warranty, repair or service the customer must provide a purchase invoice or receipt and a completed warranty registration form.

If the product develops a fault within the warranty period due to normal wear and tear, ThermoSphere at its discretion will recognise whether it's a faulty product or not. If it is impossible or not economical for the manufacturer to repair the product, the manufacturer will replace the faulty product with a new unit of the same model or if there is no stock available of the same model as the product, the manufacturer will replace the product with a new unit of a similar size. No responsibility can be taken for altered dimensions and lining up of existing holes.

The repair service offered within the warranty period only covers the faults and problems as developed from the manufacturer's errors. Any damage caused by improper use, carelessness or incorrect wiring is not covered.

ThermoSphere is not responsible for any monetary loss or injuries caused by improper use or installation of this product.

Please Note: Full Terms and Conditions are available on request.

Email [hello@thermosphere.com](mailto:hello@thermosphere.com) to request your copy or give us a call.

## Safety and care information

ThermoSphere Towel Bars should be connected to the electrical supply by a qualified electrician and in accordance with current local regulations.

We recommend that the towel bar is installed with the bottom bar at least 600mm from the floor and with a 300mm clearance from permanent fixtures.

Recommended spacing between bars is 150mm.

ThermoSphere Heated Towel Bars can be fixed onto timber stud, steel stud or masonry (solid or cavity) walls.

Stud walls require noggins at the correct position for all fixings and if the exact position cannot be determined early in the job, we recommend using noggins covered with 18mm construction ply or OSB covering a larger area.

Fixing to plasterboard or cement sheeting alone is not recommended as the boards will not support the towel bars and fixings long term.

If your towel bars are going to be installed before tiling it is imperative that the fixing spigots and/or mounting system is installed perfectly level. We recommend using a laser level and checking the level periodically throughout installation.

Towel bars are 12V SELV (safety extra low voltage) and can be installed in bathrooms.

Ensure any controls used are installed in correct zone according to the IP rating of the control.

Ensure that your towel bar electrical circuit is protected by a suitably rated RCD.

Do not use the towel bar to hold towels or other articles that have been in contact with oil, petroleum based products or dry cleaning fluids.

This appliance is intended to warm and dry towels not heat spaces.

Do not immerse your towel bar in liquid.

Ensure the transformer is located no further than 2m from the ThermoSphere Towel Bar.

Ensure the transformer is accessible and has adequate ventilation.

### Care information

The Stainless Steel finish of your towel bar is hard wearing and easy to maintain. However any harsh scrubbing, scratching or acid based cleaning products will damage the surface of your towel bar.

Clean with a soft cloth dampened with warm and mild soapy water only. Dry immediately for the best finish.

### Max weight warning

ThermoSphere towel bars are designed to hold towels only, and must not be subjected to excessive forces over 10kg. Towel bars must not be climbed on or used as support rails.

This can result in injury and can cause damage to the towel bars which is not covered under the guarantee.

# Contents

What's in the box? .....	4
Key considerations .....	5
Installing over finished tiles .....	6
Installing before tiles .....	8
Multiple bars before tiles .....	10
Cable management .....	12
Wiring schematics .....	13
Available models .....	14

## Watch the installation videos!



How to install  
over finished  
tiles



How to install  
with spigots  
before tiling



How to install  
multiple bars  
with a mounting  
system

# What's in the box?

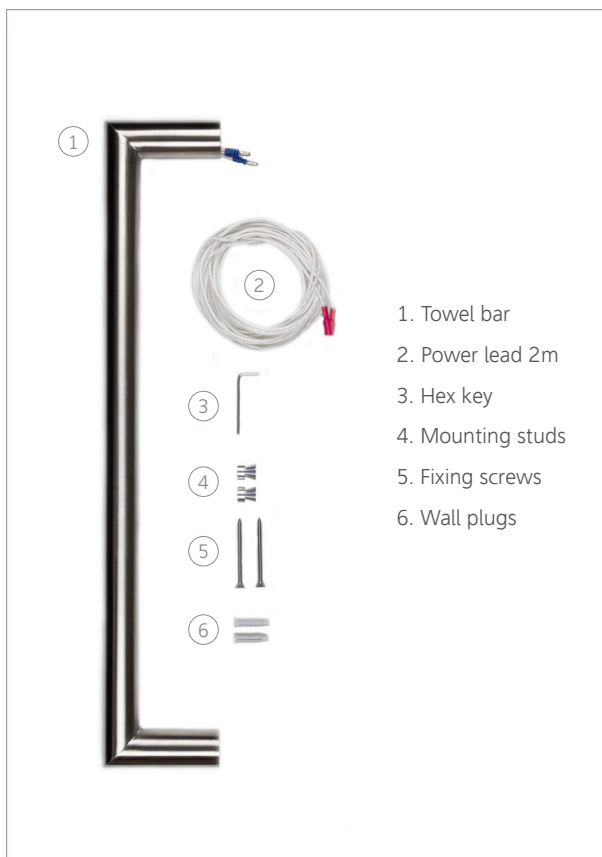

## You will also need

- Fixings that are suitable for your wall substrate
- Laser level or spirit level
- Cordless drill or impact driver
- Marker pen or pencil
- 15mm diamond hole cutter bit
- 25mm timber hole cutter bit
- Suitably rated 12V transformer(s)
- 230V electrical supply
- Fibreglass mesh tape

# Key considerations

## Install spigots (if using) before you tile!

DE Towel Bar fixing spigots are designed for installation before tiling. You must install the fixing spigots and run cables before you tile the wall. Each towel bar comes with fixing studs for installing over a finished tiled wall.

## You MUST make sure fixing spigots are level!

Because the fixing spigots and mounting systems are installed before you tile, you need to take extra care to make sure they are installed level. We recommend using a laser level throughout the process to check the towel bars are nice and level!

## Use the right fixings for your wall substrate

We recommend that you fix our Towel Bars to a solid wall, such as a brick/block cavity wall, a secure timber noggin within a cavity wall or a plywood/OSB panel. Use fixings that are suitable for the type of wall you are fixing to. We do not recommend fixing directly to plasterboard or tile backer boards as this results in loose towel bars.

## Low voltage transformers

Towel Bars are 12V and there is no polarity. You must install a suitably rated 12V transformer between the towel bar and the 230V supply. You can connect multiple towel bars to one transformer in parallel and the total load of the bars should be between the min and max rating of the transformer. The transformer should be somewhere accessible to facilitate replacement.

## Max tiling depth is 45mm

The maximum combined depth of the wall layers that will be situated over the fixing spigot is 45mm. This includes any boards, tile adhesive and tiles. Limiting the tiling depth ensures that there is enough spigot protruding from the wall to achieve a good, strong fixing to the towel bar.

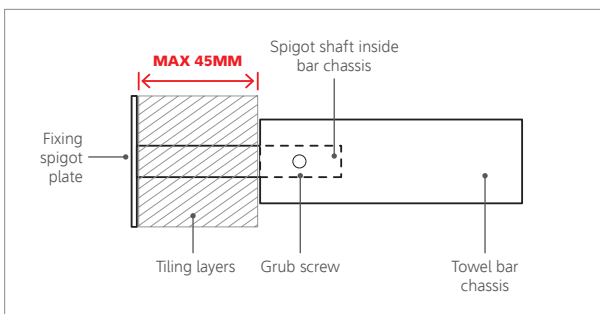

# Installing over finished tiles

With supplied mounting studs



1  
Measure and mark out fixing centres using a laser to make sure they are level.



2  
Screw the first fixing stud to the wall using a suitable fixing for the type of wall.



3  
Check the position of the second fixing stud using the towel bar and a laser level.



4  
Screw the second fixing stud to the wall using a suitable fixing for the type of wall.



5  
**Level check!**  
Check you're happy with the level by locating the towel bar over the fixing studs.

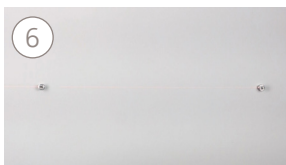

6  
Remove the towel bar from the fixing studs and keep it clean, safe and protected from scratches.

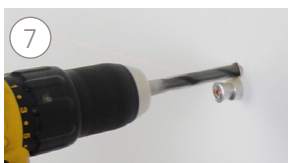

7  
Drill a 10mm hole in the wall above the right hand fixing stud.



8  
Run the 2m connection cables into the wall cavity and connect them at the transformer location.



Plug the connection cable into the towel bar with the push connections.



Push excess cable into the bar and locate the towel bar over the fixing studs.



Tighten the grub screw to hold the towel bar in place.



Tighten the second grub screw to hold the towel bar in place.



Clean the towel bar using a clean cloth that is damp with mild soapy water.



Dry and buff the towel bar with a clean dry cloth immediately for best results.



Your towel bar is installed and ready to give you warm and dry towels!



# Installing before tiles

With mounting spigots (sold separately)

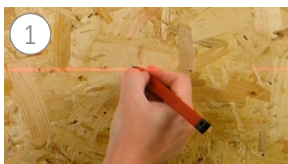

Mark out the fixing positions for the mounting spigots. A laser level is recommended.



Fix the mounting spigot securely in place. Use fixings that are suitable for your wall type.



Ensure the second spigot is level with the first and fix in position with suitable fixings.



Locate the towel bar over the spigots to make sure it fits and that you're happy with the level. Change it now if not!



If using tile backer board, install this over the spigots. Do not fix spigots to XPS or tile backer boards!

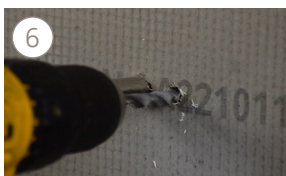

Drill a hole next to the right hand spigot to push the cables through to the wall cavity.



Cut away the tile backer board to allow a recess for the cable.



Feed the cables into the wall cavity, run to the wiring point and connect to a suitably rated 12V transformer.



9



Now tile the wall as normal. Cut a hole (**max 15 x 28mm**) in the tiles that will be installed over the spigots.

10



After the adhesive has cured, offer the towel bar up to the spigots and plug in the power cables to the element.

11



Push any excess cable into the bar (not the wall!) and push the bar over the spigots until it is tight to the wall.

12



Tighten both grub screws to hold the bar securely in position.

13



Clean the towel bar using a clean cloth that is damp with mild soapy water.

14



Dry and buff the towel bar with a clean dry cloth immediately for best results.

15



Your towel bar is installed and ready to give you warm and dry towels!

Watch the video!



# Multiple bars before tiles

With mounting system (sold separately)



1 Push spigots through the back of the mounting systems spaced correctly for each bar.



2 Fix the spigots in position with the supplied screws. Ensure they are tight and level.

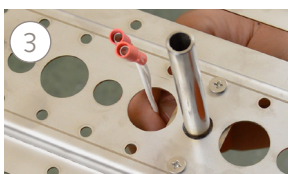

3 Push cables through the holes above each spigot and arrange in the cable channel.



4 Ensuring you don't pinch cables, fix each mounting system in one of the top corners first.



5 Use a laser level to check the mounting systems are perfectly level.



6 Fix both mounting systems in place securely with suitable fixings. Use 2 screws at each mounting spigot position.



7 Use a laser level to check the mounting systems are perfectly level.



8 Locate a towel bar over each pair of spigots to check that they are level and correctly spaced before you start tiling!



Use a laser level to check that your towel bars are level. Change it now if you need to!



Fix XPS or tile backer boards after installing the mounting system. Do not fix towel bars to XPS/backer boards.



Drill a hole in the wall at the top of the mounting system to give access to the cavity.



Pass the cables into the cavity, run to the wiring point and connect to a suitable 12V transformer.



Install the tile backer boards in accordance with the manufacturer's instructions.

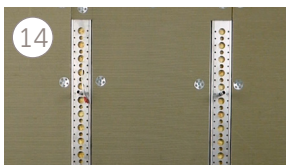

Finish over boarding the walls with XPS/backer board flush to the sides of the mounting systems.

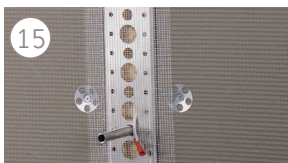

Cover the mounting systems with mesh tape. This helps to prevent the tile adhesive from slipping off the steel.

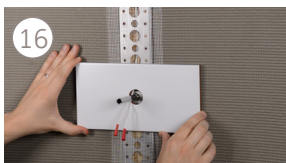

Now tile the wall as normal. Cut a hole (**max 15 x 28mm**) in the tiles that will be installed over the spigots.

# Installation continued

With mounting system (sold separately)



After the adhesive has cured, offer the towel bars up to the spigots and plug in the power cables to the elements.

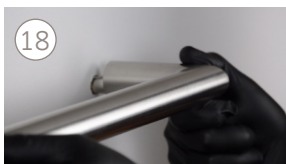

Push any excess cable into the bars (not the wall!) and push the bars over the spigots until tight to the wall.



Tighten both grub screws to hold the bars securely in position.

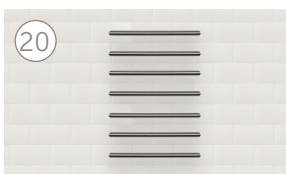

Your towel bars are installed and ready to give you warm and dry towels!

## Cable management

The mounting system makes cable management easy. You can run the cables behind the mounting system and drill a hole at the top to pass them into the cavity and up to your wiring point.

If you're installing onto a solid brick/block wall you will need to chase a channel for the cables or use multiple mounting systems to run the cables behind. Cover the wall with a backer board flush to the mounting systems before installing tiles.

**Watch the video!**



**Wiring video!**



# Wiring schematics

All electrical work must be compliant with the relevant local regulations and carried out by a professional electrician. Isolate the electrical supply before you start.

## Single towel bars

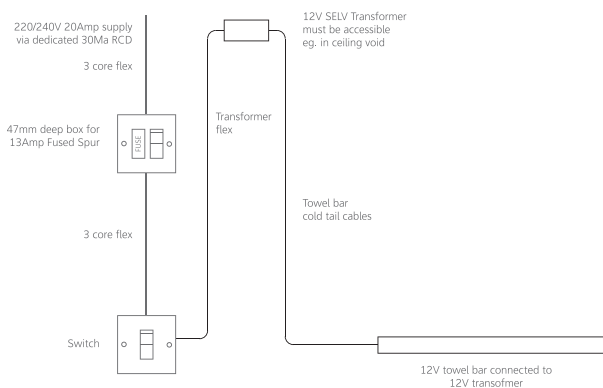

## Multiple towel bars

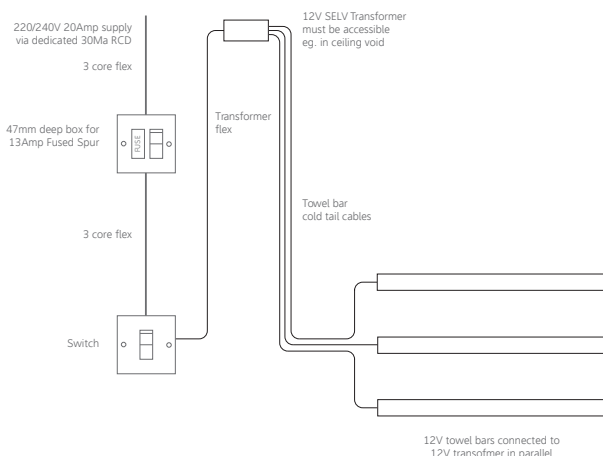

ThermoSphere Towel Bars are 12V SELV and can be installed safely anywhere in a bathroom. All electrical circuits in bathrooms must be protected by a suitably rated RCD.

# Available models



## Round 450mm profile

SKU	Finish	Size (mm)	Output (W@ 10°C)
HTB-DR-450-DPS	Diamond polished	450 x 32 x 100 (c418)	25
HTB-DR-450-BSS	Brushed stainless steel	450 x 32 x 100 (c418)	25
HTB-DR-450-PLB	Polished brass	450 x 32 x 100 (c418)	25
HTB-DR-450-BRB	Brushed brass	450 x 32 x 100 (c418)	25
HTB-DR-450-MBK	Matt black	450 x 32 x 100 (c418)	25
HTB-DR-450-MWT	Matt white	450 x 32 x 100 (c418)	25

## Round 632mm profile

SKU	Finish	Size (mm)	Output (W@ 10°C)
HTB-DR-632-DPS	Diamond polished	632 x 32 x 100 (c600)	37
HTB-DR-632-BSS	Brushed stainless steel	632 x 32 x 100 (c600)	37
HTB-DR-632-PLB	Polished brass	632 x 32 x 100 (c600)	37
HTB-DR-632-BRB	Brushed brass	632 x 32 x 100 (c600)	37
HTB-DR-632-MBK	Matt black	632 x 32 x 100 (c600)	37
HTB-DR-632-MWT	Matt white	632 x 32 x 100 (c600)	37



## Square 450mm profile

SKU	Finish	Size (mm)	Output (W@ 10°C)
HTB-DS-450-DPS	Diamond polished	450 x 40 x 100 (c430)	25
HTB-DS-450-BSS	Brushed stainless steel	450 x 40 x 100 (c430)	25
HTB-DS-450-PLB	Polished brass	450 x 40 x 100 (c430)	25
HTB-DS-450-BRB	Brushed brass	450 x 40 x 100 (c430)	25
HTB-DS-450-MBK	Matt black	450 x 40 x 100 (c430)	25
HTB-DS-450-MWT	Matt white	450 x 40 x 100 (c430)	25

## Square 632mm profile

SKU	Finish	Size (mm)	Output (W@ 10°C)
HTB-DS-632-DPS	Diamond polished	632 x 40 x 100 (c612)	37
HTB-DS-632-BSS	Brushed stainless steel	632 x 40 x 100 (c612)	37
HTB-DS-632-PLB	Polished brass	632 x 40 x 100 (c612)	37
HTB-DS-632-BRB	Brushed brass	632 x 40 x 100 (c612)	37
HTB-DS-632-MBK	Matt black	632 x 40 x 100 (c612)	37
HTB-DS-632-MWT	Matt white	632 x 40 x 100 (c612)	37

**Thermogroup Ltd  
T/A ThermoSphere**

Bridge House  
Pattenden Lane  
Marden  
Kent  
TN12 9QJ  
UNITED KINGDOM

[www.thermosphere.com](http://www.thermosphere.com)  
[hello@thermosphere.com](mailto:hello@thermosphere.com)  
+44 (0) 800 019 5899



 **DESIGNED AND MADE  
IN GREAT BRITAIN**