

1

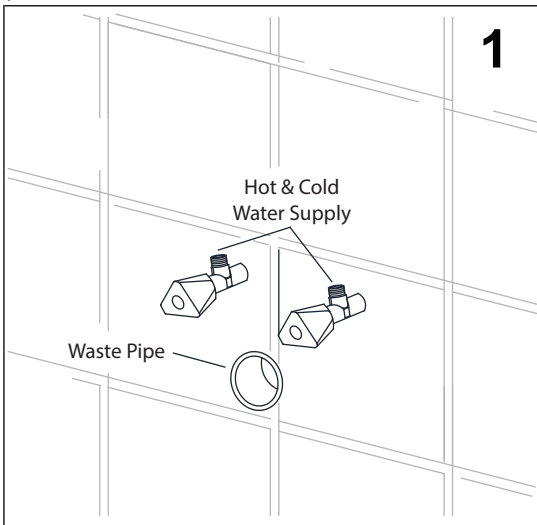

2

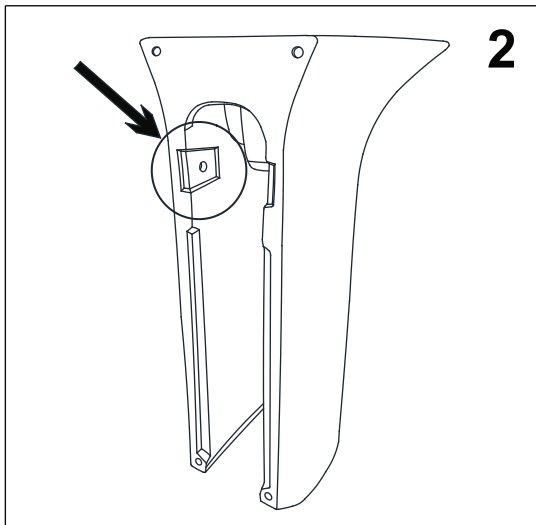

SENF555

[x 1]

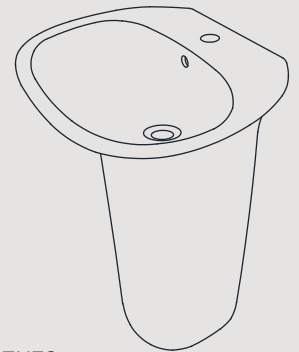

a.

b.

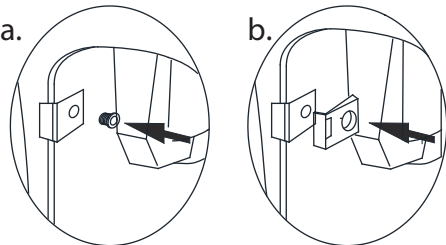

c.

d.

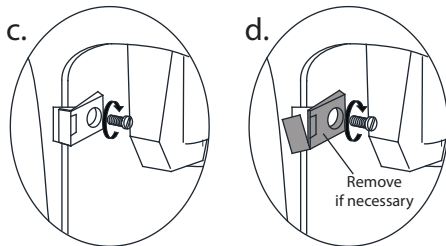

3

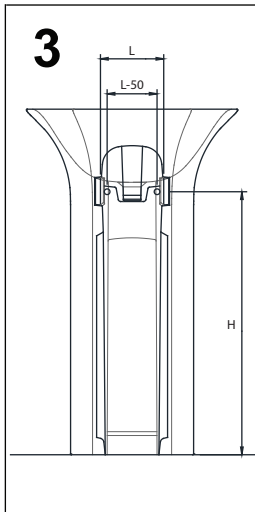

4

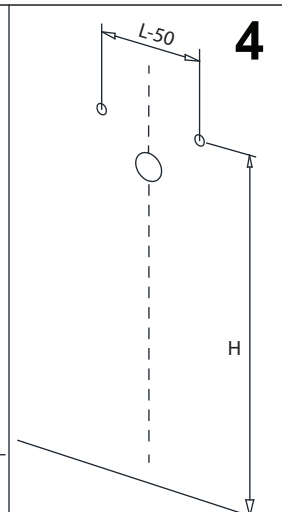

FS37F

[x 2]

[x 2]

