

MIO 1/2 C

MIOS Tap Range Mios 1/2 inch Basin Taps Chrome



Features:

- Long life 1/4 turn ceramic disc valves for added durability and smooth control.
- Robust metal fixing nut to secure the tap in place reducing the risk of loosening over time.
- A hard-wearing, flawless, scratch resistant chrome finish that lasts for years. Salt spray tested to ensure added durability.
- 5 year parts and 1 year labour guarantee for peace of mind.
- Co-ordinating Bathroom taps available.

Product Certifications:



WRAS Certificate No: 1911937
WRAS Expiry Date: 30/11/2024



For more products, visit our website:
<http://www.bristan.com>



Specification

Product Type:	Bathroom Taps
Main Construction Material:	Brass
Mount Type:	Deck Mounted
Handle Type:	Lever Handle
Connection Inlet:	G 1/2" BSP
Connection Outlet:	Housed M20 Flow Straightener
Number of Tap Holes:	2
Valve/Cartridge Type:	Ceramic Disc Valve
Plumbing System Requirements:	Suitable for all plumbing systems
Minimum Dynamic Pressure (bar):	0.2 bar
Maximum Dynamic Pressure (bar):	5.0 bar
Maximum Hot Water Temperature °C:	60°C
Maximum Static Pressure (bar):	10 bar
Isolation Included:	No

Dimensions (measurements in mm)

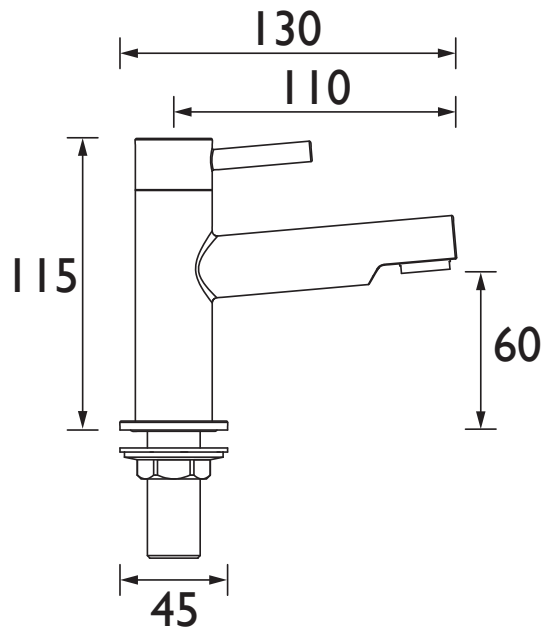

Flow Rates (l/min)

System Pressure (bar)	0.2	0.5	1	2	3	5
MIO 1/2 C (Cold)	8	12.6	17.2	23.7	30	37.3
MIO 1/2 C (Hot)	8.3	12.9	17.9	24.7	31.3	38.8

TECHNICAL
DATA
SHEET



BRISTAN

D2