

Sales Code: FJ314

Description: Series 2 Bsm W/ Shower Kit & Bracket

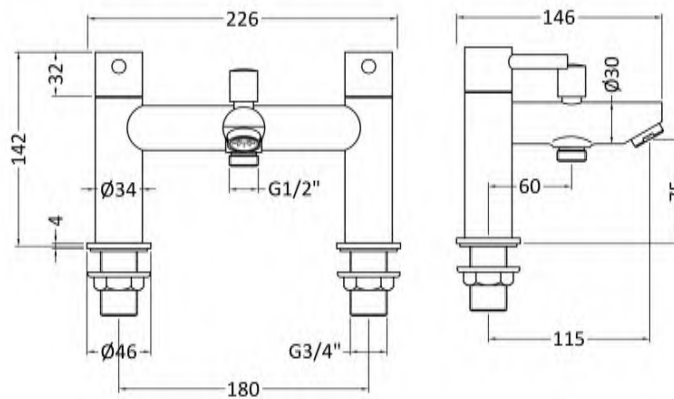

Product Dimensions

Height (mm):	142
Width (mm):	226
Depth (mm):	146
Length (mm):	
Nett Weight (kg):	0.9

Packaging Dimensions

Height (mm):	210
Width (mm):	155
Depth (mm):	250
Gross Weight (kg):	1.4

Packaging Data

Box Colour:	White Cardboard Box
Box Qty:	1
Label Size:	100 x 50
Label Colour:	White Label
Label Qty:	2

Outer Box Dimensions (If Applicable)

Height (mm):	400
Width (mm):	270
Depth (mm):	430
Length (mm):	
Gross Weight (kg):	10
Barcode:	5055146175247

Product Details

Country of Origin:	China
Fitting Instruction:	No
Product Material:	Brass/ABS
Control Type:	Manual
Waste Included:	Waste Not Included
Waste Type:	Not Applicable
WRAS Approval: No	Approval No: N/A
Valve/Cartridge Type:	1/4 Turn Ceramic Disc
Colour/Finish:	Chrome
Mount Type:	Deck
Operating Pressure (bar):	1

Flow Rates: (Litres Per Min) 0.1 bar: 7 0.5 bar: 22 1 bar: 34 2 bar: 40 3 bar: 0

Pipe Size: 22 mm (3/4" Bsp)

Pipe Centres: 180 mm