

PRODUCT DATA SHEET



PRODUCT CODE

RT015C

RANGE

Rotar

DESCRIPTION

Rotar Towel Rail 600mm Chrome

WEBSITE LINK [Click Here](#)

CATEGORY	Accessories
WARRANTY DETAILS	15 Years
COLOUR	Chrome
FINISH APPLICATION	Electroplated
PRIMARY MATERIAL	Brass
SECONDARY MATERIAL	Zamac
INSTALL TYPE	Wall Mounted
PRODUCT WIDTH MM	600
PRODUCT HEIGHT MM	42
PRODUCT DEPTH MM	68
PRODUCT NET WEIGHT KG	1.5

TECHNICAL DIMENSIONS

Dimensions in mm unless otherwise specified.

Tolerances (per material type) apply.

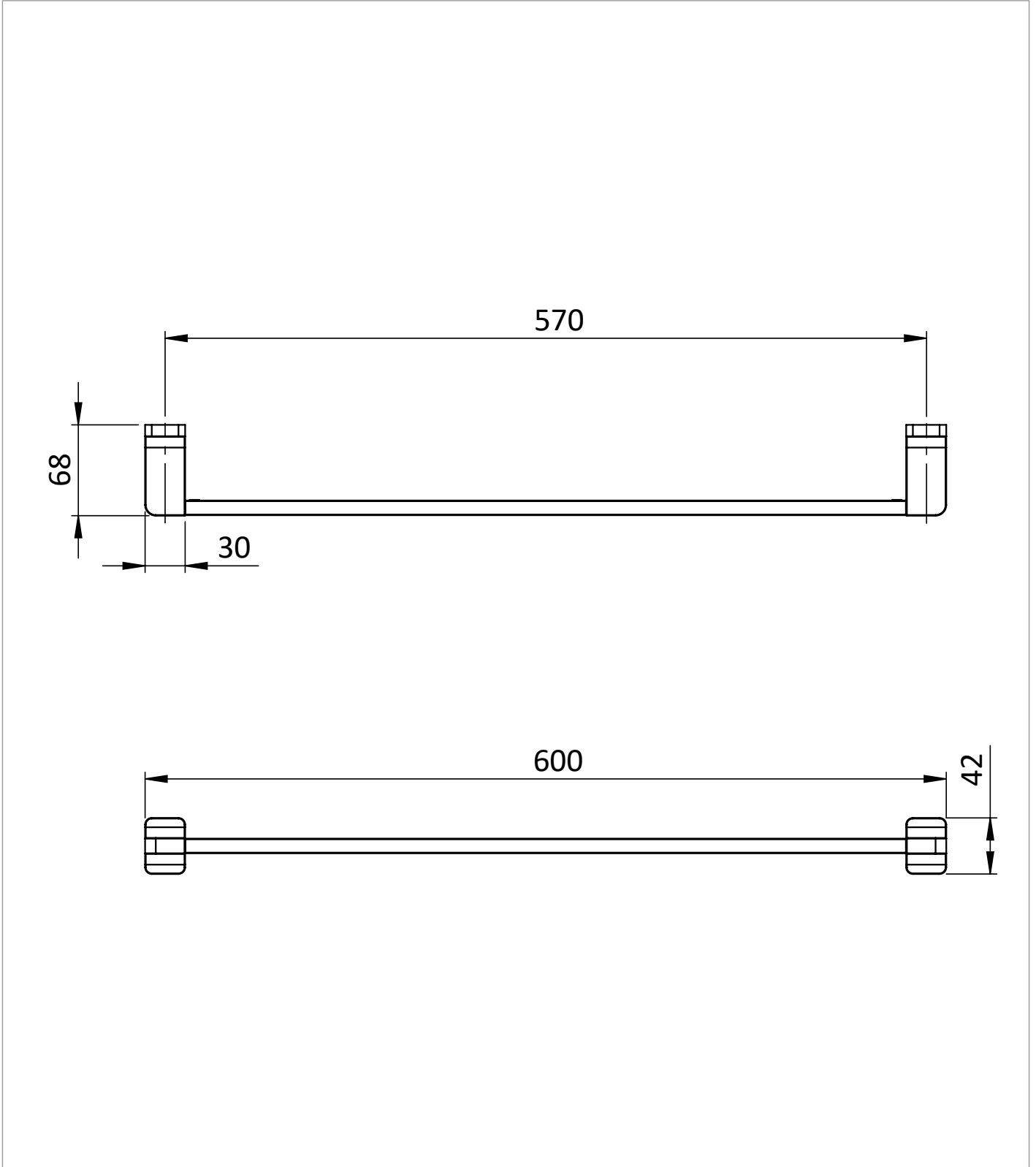

SPARES LIST

Only the parts labelled are available as spares.

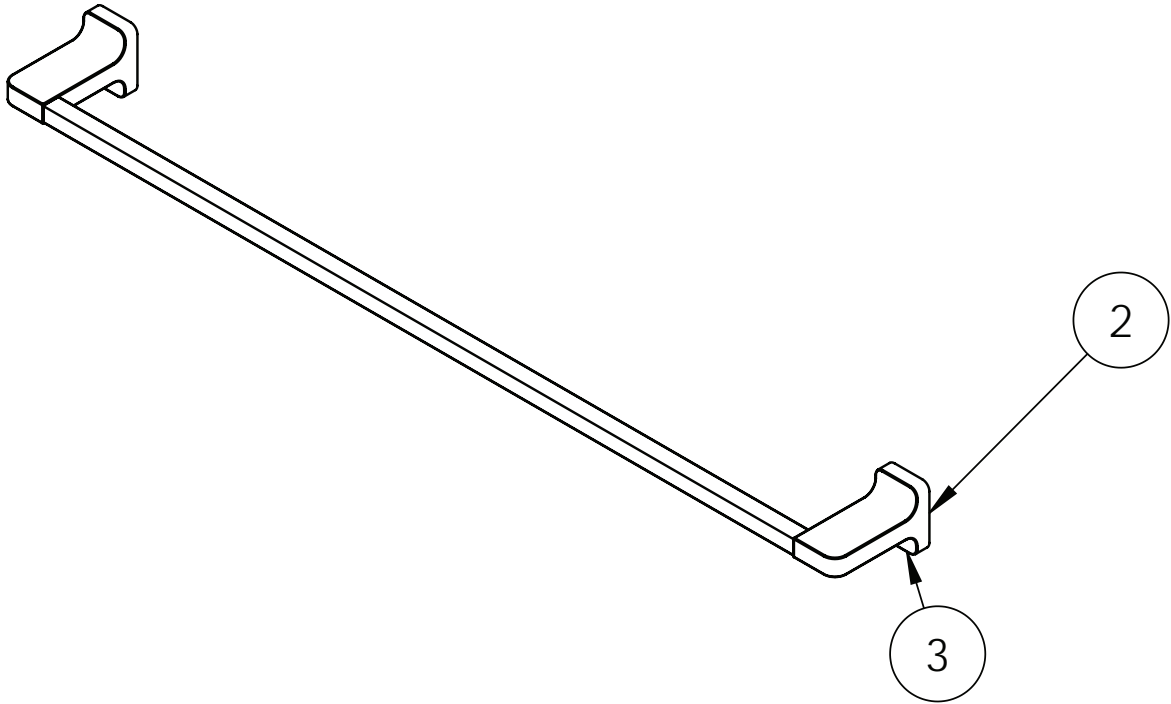

NUMBER	PART CODE	DESCRIPTION
1	RT00001	Rotar Screw Bag for RT023/RT015
2	RT00002	Rotar Wall Mounting Plate for RT021/RT013/RT029/RT025/RT023/RT015
3	RT00004	Rotar Grub Screws for RT021/RT003/RT011/RT013/RT029/RT025/RT023/RT015