

PRODUCT DATA SHEET



PRODUCT CODE

WCF114X50R

RANGE

Toilet Cisterns

DESCRIPTION

Slim Depth WC Support Frame 1.12M Height (with dual flush concealed cistern & installation kit)

CATEGORY	Sanitaryware
WARRANTY DETAILS	5 Years
PRIMARY MATERIAL	Steel
SECONDARY MATERIAL	Plastic
INSTALL TYPE	Floor Standing
PRODUCT WIDTH MM	497
PRODUCT HEIGHT MM	1120
PRODUCT LENGTH MM	81
PRODUCT NET WEIGHT KG	13.02
STANDARDS	BS EN 14055:2018

FIXINGS INCLUDED	Yes
FLUSH VOLUME	6/4L
FIXING TYPE	Floor fixing
CISTERN FLUSH MECHANISM	Dual Flush with Mechanical Flush Plate
NOISE CLASS	Group I

TECHNICAL DIMENSIONS

Dimensions in mm unless otherwise specified.

Tolerances (per material type) apply.

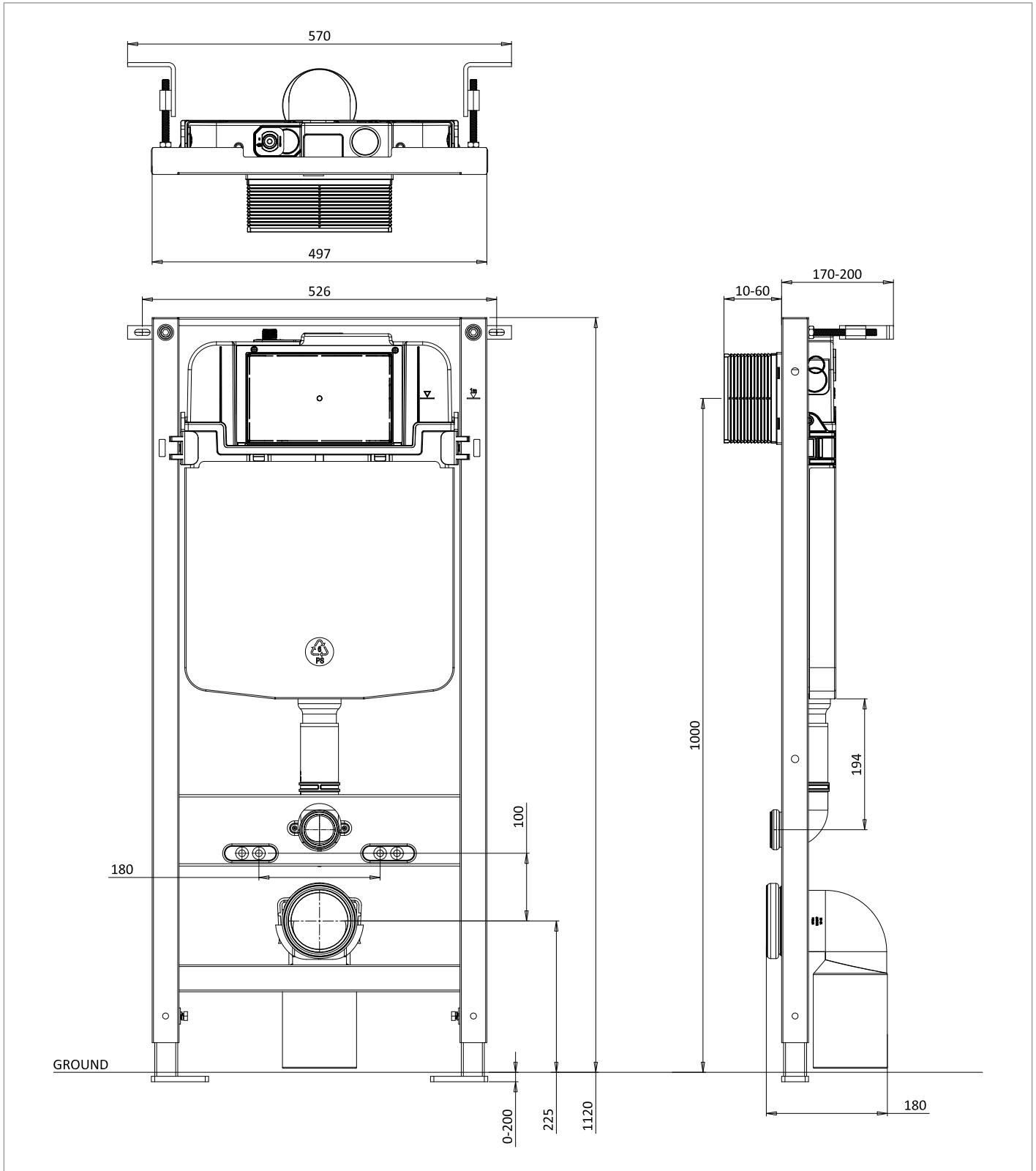

SPARES LIST

Only the parts labelled are available as spares.

SPARES AVAILABLE UPON REQUEST