

Sales Code: ENZW004

Barcode: 5056678428849

Brand: nuie

Description: nuie 700mm Framed Walk-In Wetroom Screen Set With Tray



Technical Drawing Not Available

Product Dimensions

Product	1950 x 700 x 14mm (H x W x D)
Nett Weight	85 kg
Packaged Weight	85 kg

Product Details

Country of Origin	China
Product Material	Acrylic Capped Abs Caco3 And Pu,Aluminium,Glass
Colour/Finish	Matt Black
Style	Contemporary
Ce Certified	Yes
Enclosure Design	Framed
Glass Thickness	8 mm
Waste Included	No

Sales Code: WRSF070

Barcode: 5056211806882

Brand: Hudson Reed

Description: Hudson Reed 700mm Framed Matrix Matt Black Wetroom Screen

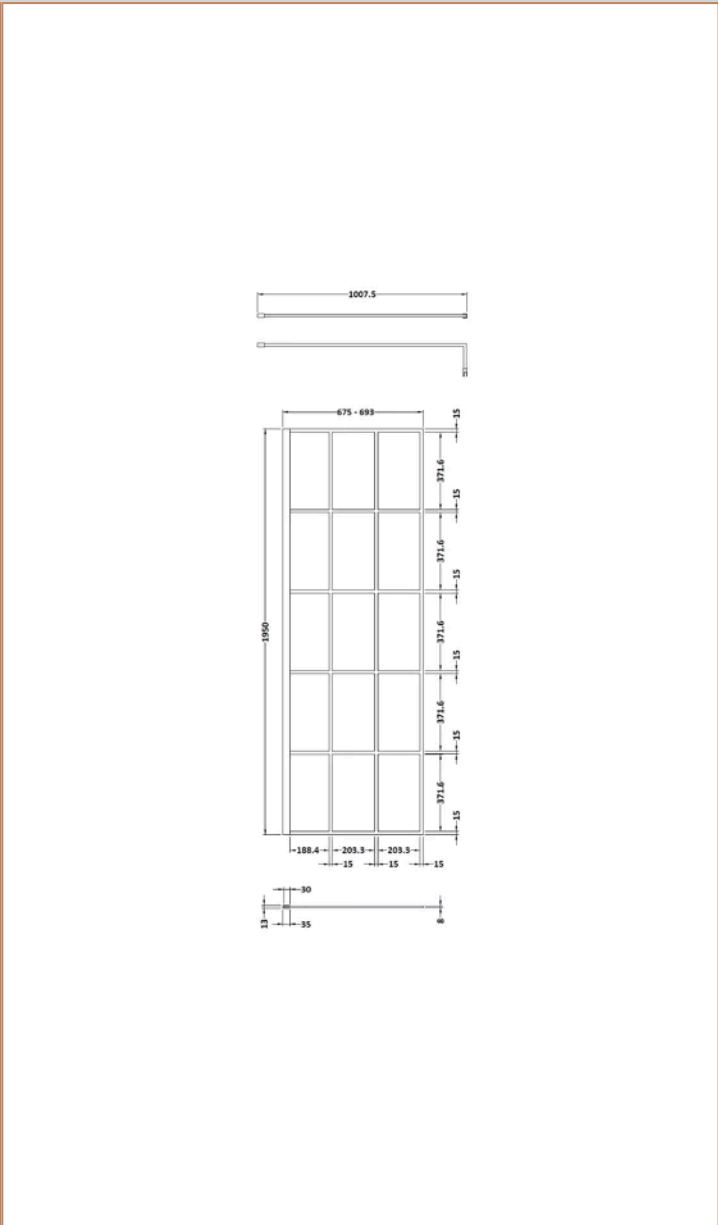

Product Dimensions

Product	1950 x 700 x 14mm (H x W x D)
Packaged	60 x 750 x 2070mm (H x W x D)
Nett Weight	31.1 kg
Packaged Weight	31.1 kg

Product Details

Country of Origin	China
Product Material	Aluminium
Colour/Finish	Matt Black
Style	Contemporary
Fixings Included	Yes
Easy Clean	Yes
Adjustment Max	693
Adjustment Min	675
Ce Certified	Yes
Declaration Of Performance	Yes
Easy Fit	No
Enclosure Design	Framed
Frame Finish	Matt Black
Glass Thickness	8 mm
Handles Included	No
Support Bar Included	Yes
Ukca Certified	Yes

Sales Code: NTP011

Barcode: 5055369025381

Brand: nuie

Description: nuie 1200 x 700mm Rectangular Shower Tray

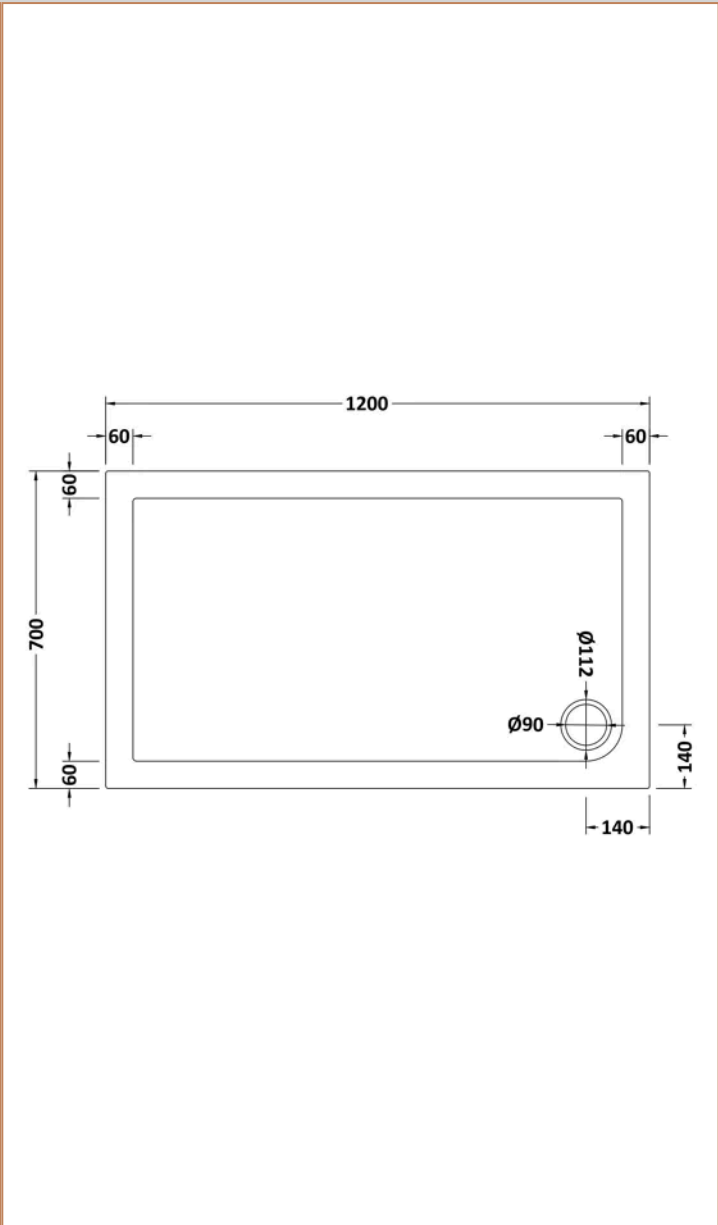

Product Dimensions

Product	40 x 700 x 1200mm (H x W x L)
Packaged	80 x 740 x 1240mm (H x W x D)
Nett Weight	26.4 kg
Packaged Weight	26.7 kg

Product Details

Country of Origin	United Kingdom
Product Material	Acrylic Capped Abs Caco3 And Pu
Colour/Finish	White
Style	Contemporary
Fixings Included	No
Ce Certified	Yes
Leg Set Included	No
Legs Included	No
Raised Edge	Yes
Slip Resistant	No
Waste Included	No
Waste Size Required	90mm

Sales Code: ENZW008

Barcode: 5056678428801

Brand: nuie

Description: nuie 800mm Framed Walk-In Wetroom Screen Set With Tray



Technical Drawing Not Available

Product Dimensions

Product	1950 x 800 x 14mm (H x W x D)
Nett Weight	92 kg
Packaged Weight	92 kg

Product Details

Country of Origin	China
Product Material	Acrylic Capped Abs Caco3 And Pu,Aluminium,Glass
Colour/Finish	Matt Black
Style	Contemporary
Ce Certified	Yes
Enclosure Design	Framed
Glass Thickness	8 mm
Waste Included	No

Sales Code: WRSF070

Barcode: 5056211806882

Brand: Hudson Reed

Description: Hudson Reed 700mm Framed Matrix Matt Black Wetroom Screen

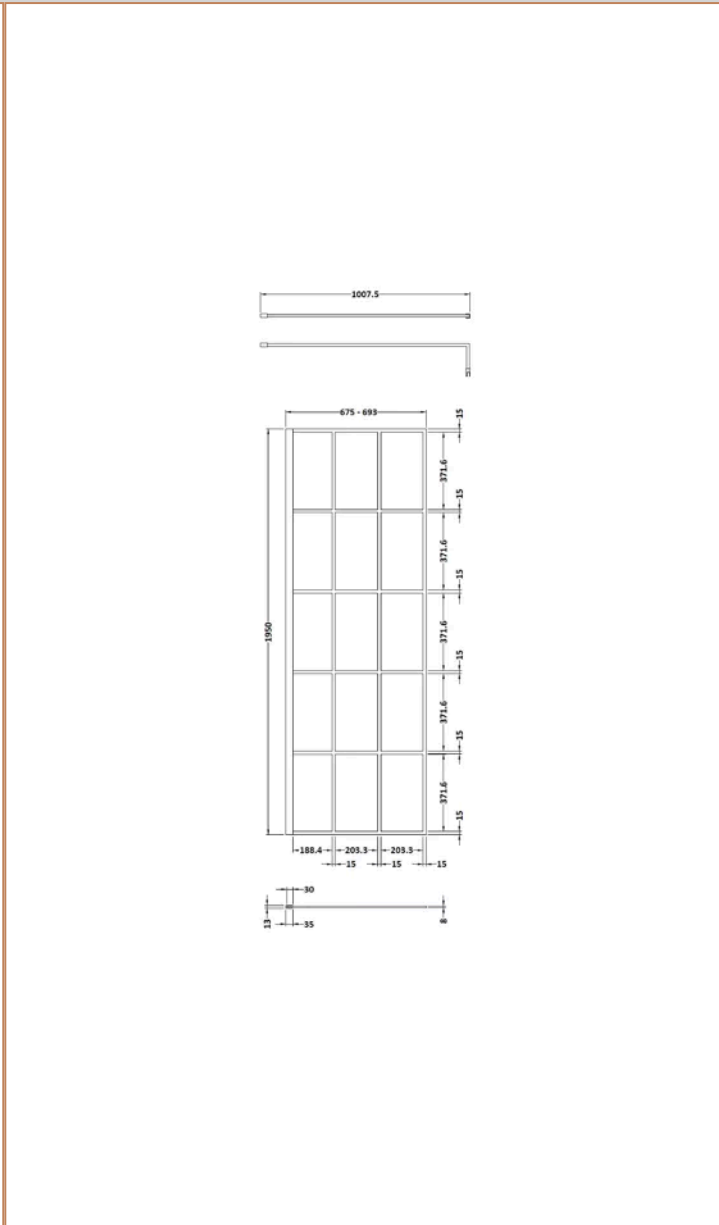
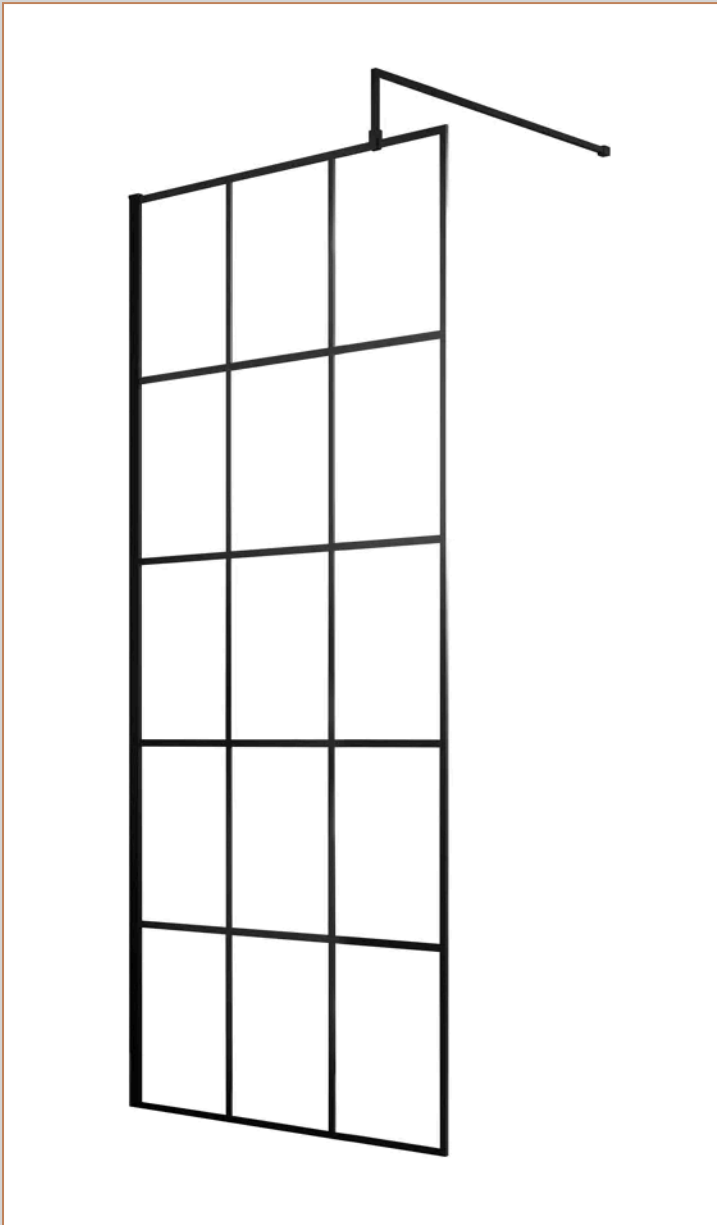

Product Dimensions

Product	1950 x 700 x 14mm (H x W x D)
Packaged	60 x 750 x 2070mm (H x W x D)
Nett Weight	31.1 kg
Packaged Weight	31.1 kg

Product Details

Country of Origin	China
Product Material	Aluminium
Colour/Finish	Matt Black
Style	Contemporary
Fixings Included	Yes
Easy Clean	Yes
Adjustment Max	693
Adjustment Min	675
Ce Certified	Yes
Declaration Of Performance	Yes
Easy Fit	No
Enclosure Design	Framed
Frame Finish	Matt Black
Glass Thickness	8 mm
Handles Included	No
Support Bar Included	Yes
Ukca Certified	Yes

Sales Code: NTP023

Barcode: 5055369006311

Brand: nuie

Description: nuie 1200 x 800mm Rectangular Shower Tray

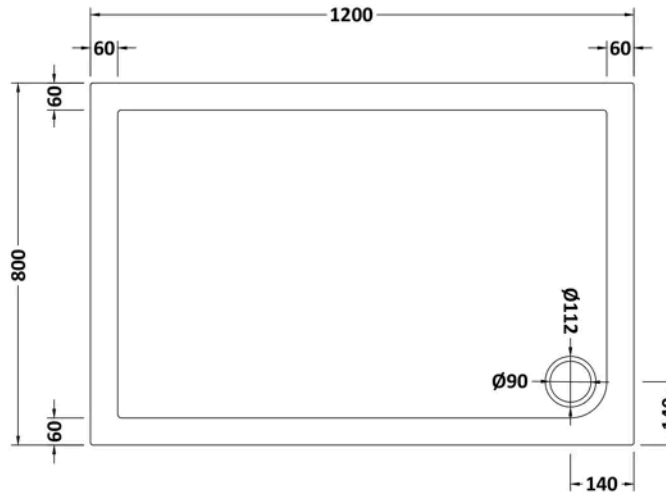

Product Dimensions

Product	40 x 800 x 1200mm (H x W x L)
Packaged	80 x 840 x 1240mm (H x W x D)
Nett Weight	29.8 kg
Packaged Weight	30.1 kg

Product Details

Country of Origin	United Kingdom
Product Material	Acrylic Capped Abs Caco3 And Pu
Colour/Finish	White
Style	Contemporary
Fixings Included	No
Ce Certified	Yes
Leg Set Included	No
Legs Included	No
Raised Edge	Yes
Slip Resistant	No
Waste Included	No
Waste Size Required	90mm

Sales Code: ENZW012

Barcode: 5056678428764

Brand: nuie

Description: nuie 900mm Framed Walk-In Wetroom Screen Set With Tray



Technical Drawing Not Available

Product Dimensions

Product	1950 x 900 x 14mm (H x W x D)
Nett Weight	98.8 kg
Packaged Weight	98.8 kg

Product Details

Country of Origin	China
Product Material	Acrylic Capped Abs Caco3 And Pu,Aluminium,Glass
Colour/Finish	Matt Black
Style	Contemporary
Ce Certified	Yes
Enclosure Design	Framed
Glass Thickness	8 mm
Waste Included	No

Sales Code: WRSF070

Barcode: 5056211806882

Brand: Hudson Reed

Description: Hudson Reed 700mm Framed Matrix Matt Black Wetroom Screen

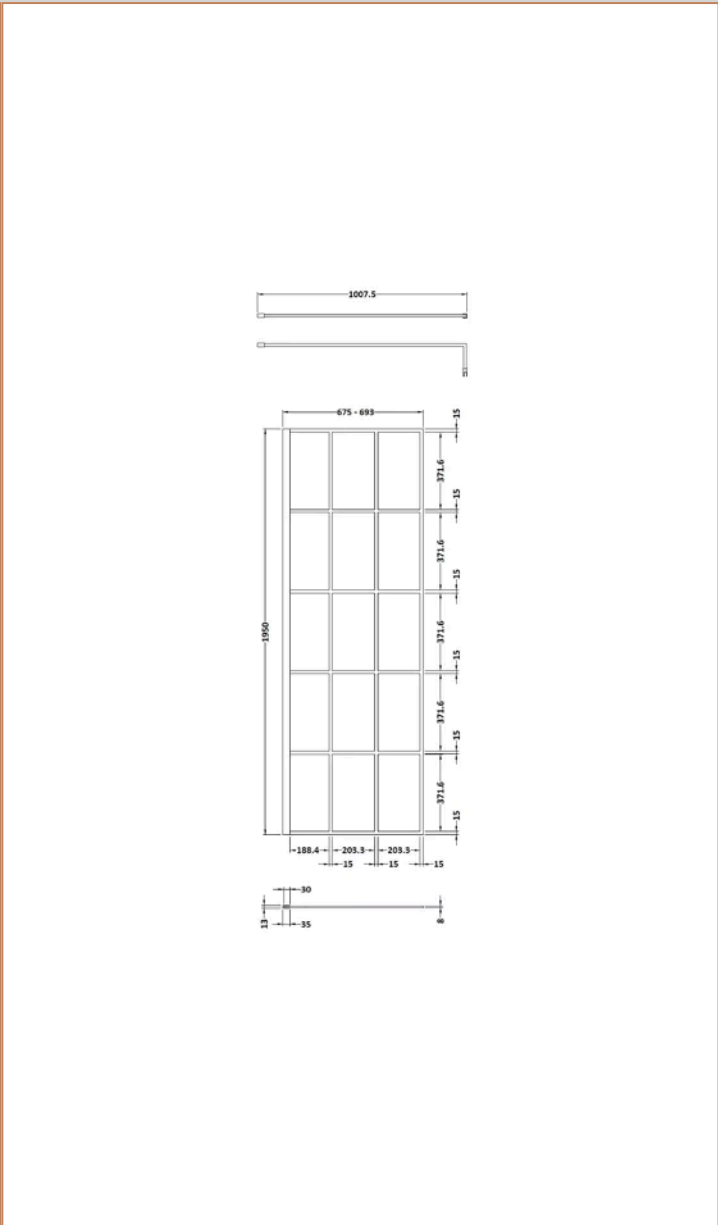
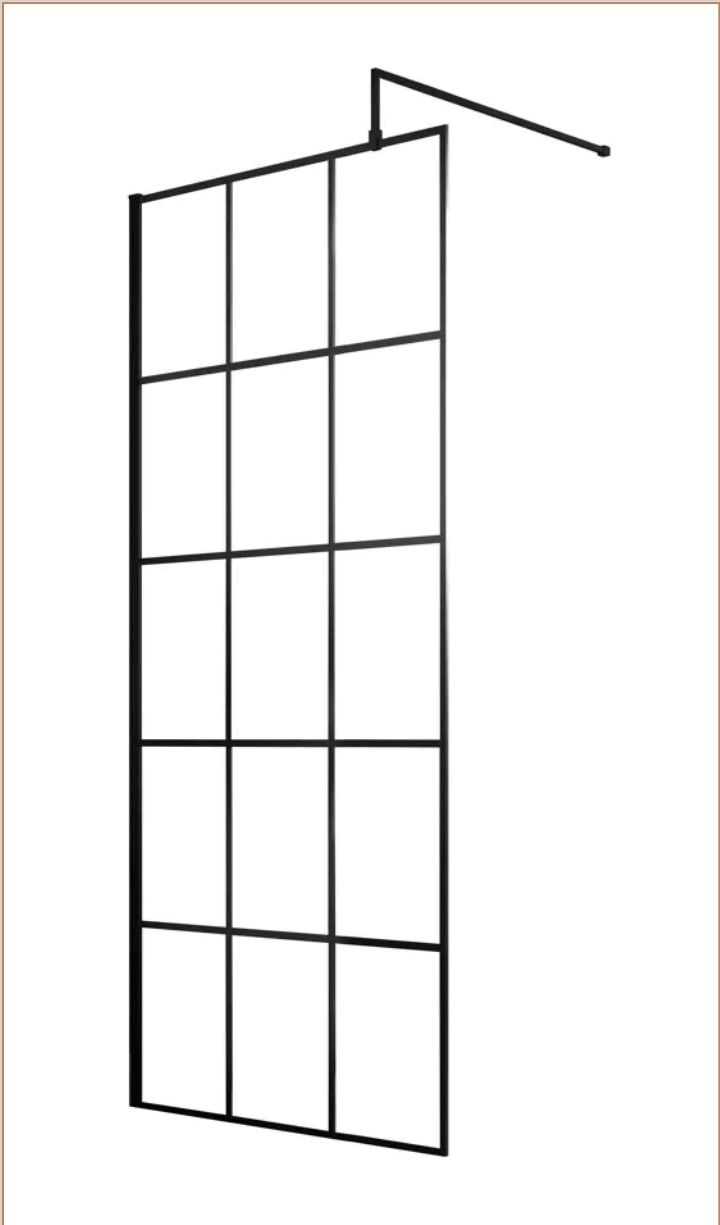

Product Dimensions

Product	1950 x 700 x 14mm (H x W x D)
Packaged	60 x 750 x 2070mm (H x W x D)
Nett Weight	31.1 kg
Packaged Weight	31.1 kg

Product Details

Country of Origin	China
Product Material	Aluminium
Colour/Finish	Matt Black
Style	Contemporary
Fixings Included	Yes
Easy Clean	Yes
Adjustment Max	693
Adjustment Min	675
Ce Certified	Yes
Declaration Of Performance	Yes
Easy Fit	No
Enclosure Design	Framed
Frame Finish	Matt Black
Glass Thickness	8 mm
Handles Included	No
Support Bar Included	Yes
Ukca Certified	Yes

Sales Code: WRSF090

Barcode: 5056211806912

Brand: Hudson Reed

Description: Hudson Reed 900mm Matt Black Matrix Framed Wetroom Screen

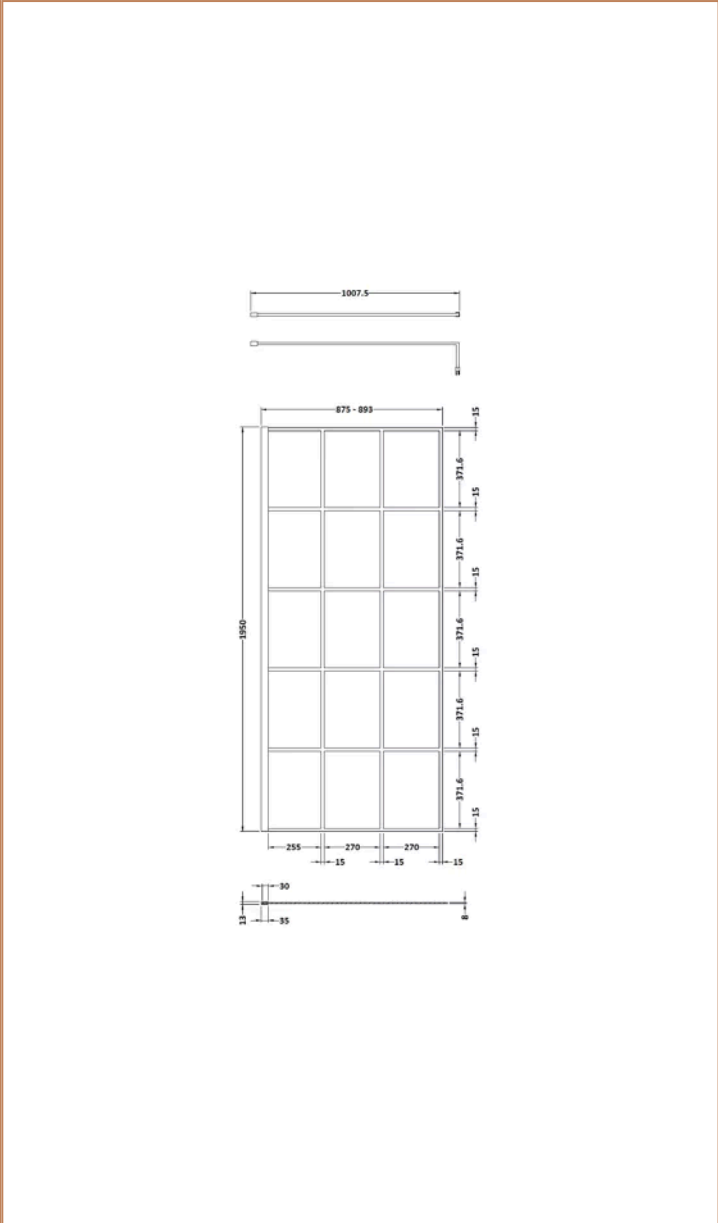
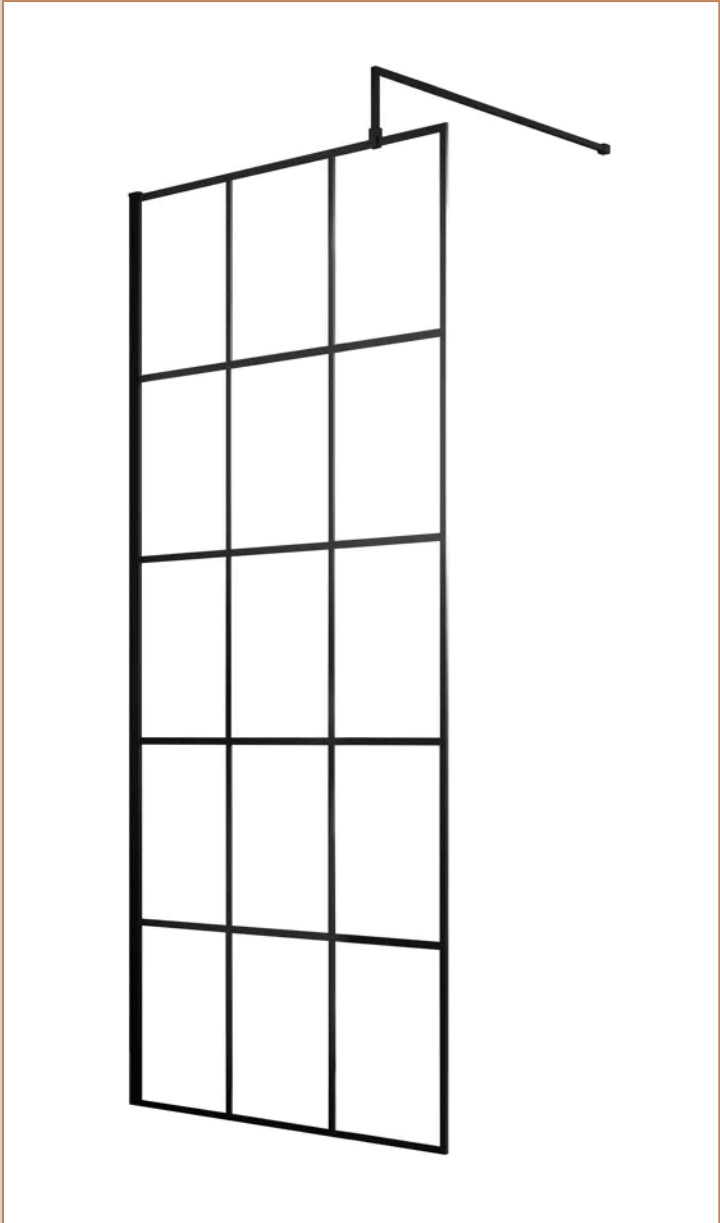

Product Dimensions

Product	1950 x 900 x 14mm (H x W x D)
Packaged	60 x 950 x 2070mm (H x W x D)
Nett Weight	40.3 kg
Packaged Weight	40.3 kg

Product Details

Country of Origin	China
Product Material	Aluminium
Colour/Finish	Matt Black
Style	Contemporary
Fixings Included	Yes
Easy Clean	Yes
Adjustment Max	893
Adjustment Min	875
Ce Certified	Yes
Declaration Of Performance	Yes
Easy Fit	No
Enclosure Design	Framed
Frame Finish	Matt Black
Glass Thickness	8 mm
Handles Included	No
Support Bar Included	Yes
Ukca Certified	Yes

Sales Code: NTP024

Barcode: 5055369006328

Brand: nuie

Description: nuie 1200 x 900mm Rectangular Shower Tray

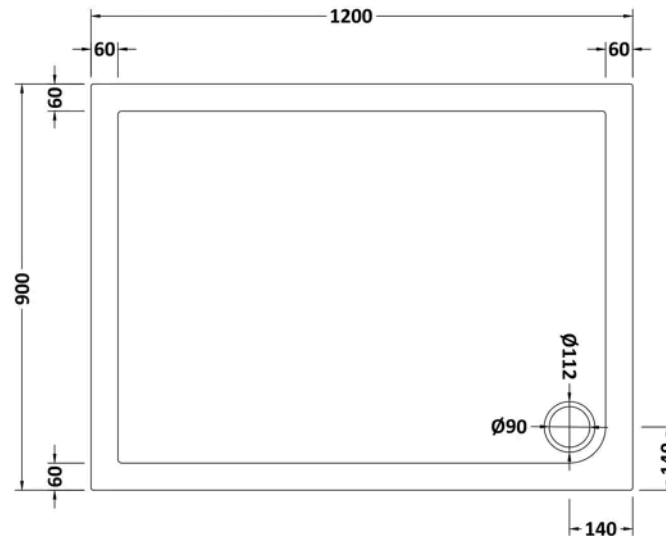

Product Dimensions

Product	40 x 900 x 1200mm (H x W x L)
Packaged	80 x 940 x 1240mm (H x W x D)
Nett Weight	31.7 kg
Packaged Weight	32 kg

Product Details

Country of Origin	United Kingdom
Product Material	Acrylic Capped Abs Caco3 And Pu
Colour/Finish	White
Style	Contemporary
Fixings Included	No
Ce Certified	Yes
Leg Set Included	No
Legs Included	No
Raised Edge	Yes
Slip Resistant	No
Waste Included	No
Waste Size Required	90mm

Sales Code: ENZW016

Barcode: 5056678428726

Brand: nuie

Description: nuie 900mm Framed Walk-In Wetroom Screen Set With Tray



Technical Drawing Not Available

Product Dimensions

Product	1950 x 900 x 14mm (H x W x D)
Nett Weight	97.4 kg
Packaged Weight	97.4 kg

Product Details

Country of Origin	China
Product Material	Acrylic Capped Abs Caco3 And Pu,Aluminium,Glass
Colour/Finish	Matt Black
Style	Contemporary
Ce Certified	Yes
Enclosure Design	Framed
Glass Thickness	8 mm
Waste Included	No

Sales Code: WRSF070

Barcode: 5056211806882

Brand: Hudson Reed

Description: Hudson Reed 700mm Framed Matrix Matt Black Wetroom Screen

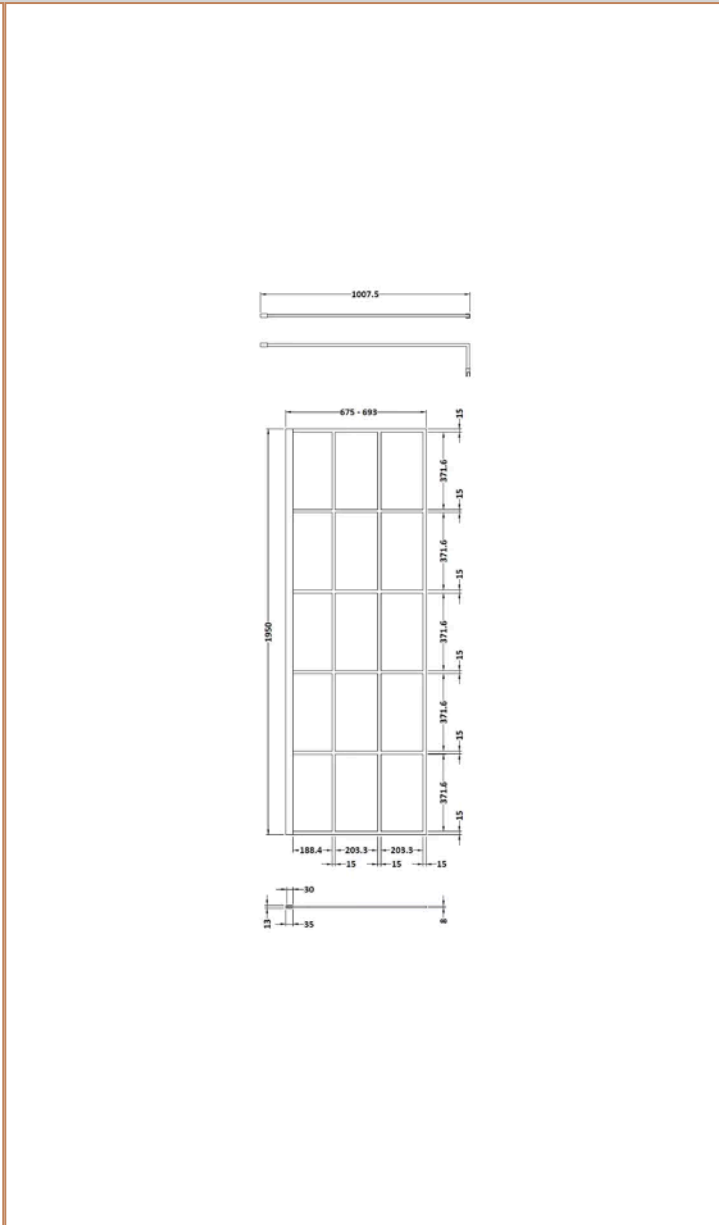
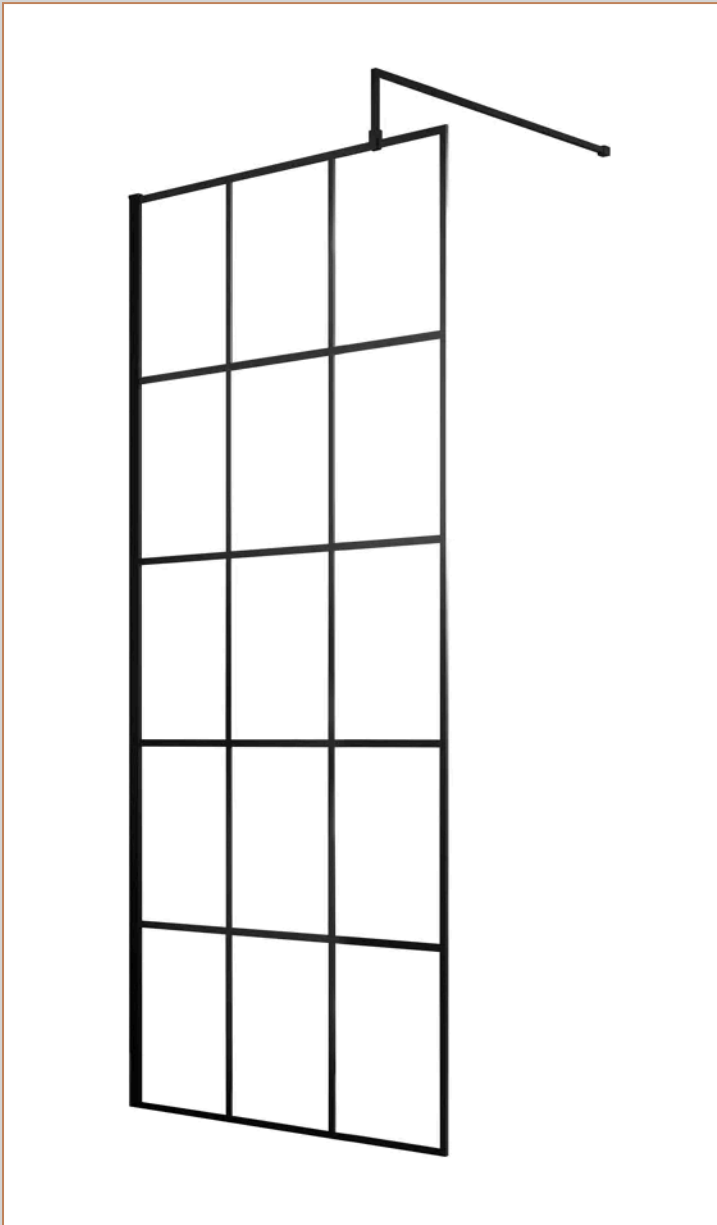

Product Dimensions

Product	1950 x 700 x 14mm (H x W x D)
Packaged	60 x 750 x 2070mm (H x W x D)
Nett Weight	31.1 kg
Packaged Weight	31.1 kg

Product Details

Country of Origin	China
Product Material	Aluminium
Colour/Finish	Matt Black
Style	Contemporary
Fixings Included	Yes
Easy Clean	Yes
Adjustment Max	693
Adjustment Min	675
Ce Certified	Yes
Declaration Of Performance	Yes
Easy Fit	No
Enclosure Design	Framed
Frame Finish	Matt Black
Glass Thickness	8 mm
Handles Included	No
Support Bar Included	Yes
Ukca Certified	Yes

Sales Code: WRSF090

Barcode: 5056211806912

Brand: Hudson Reed

Description: Hudson Reed 900mm Matt Black Matrix Framed Wetroom Screen

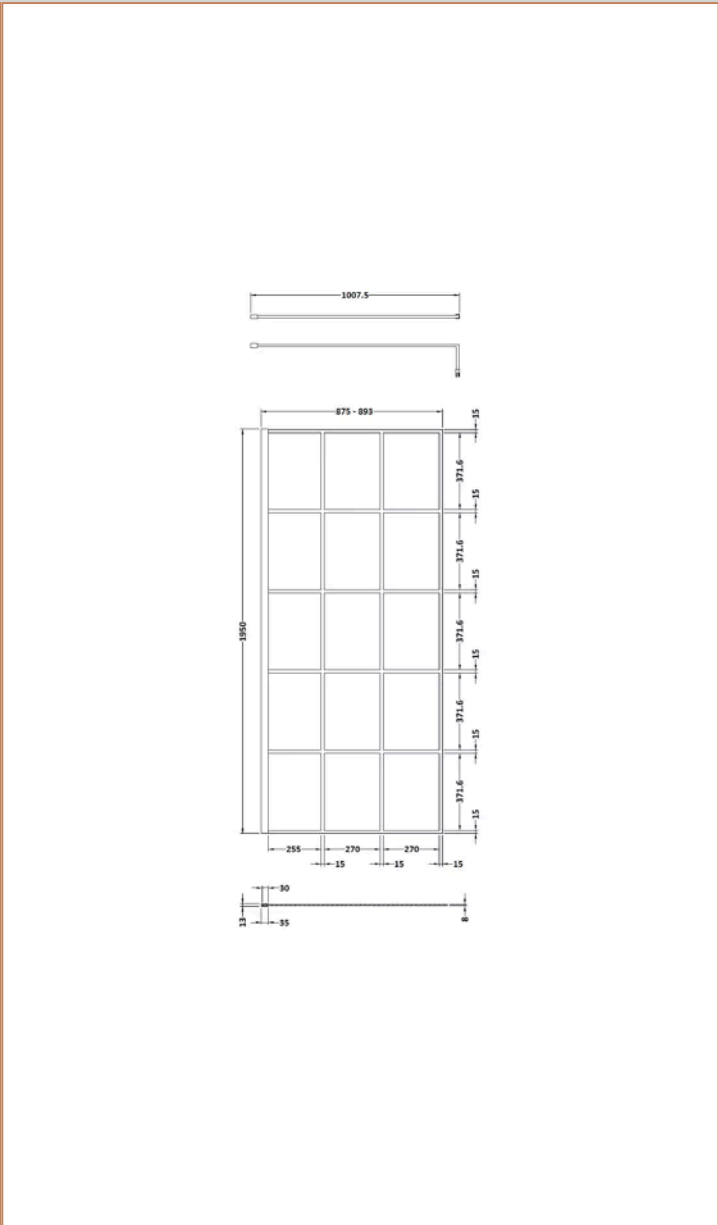
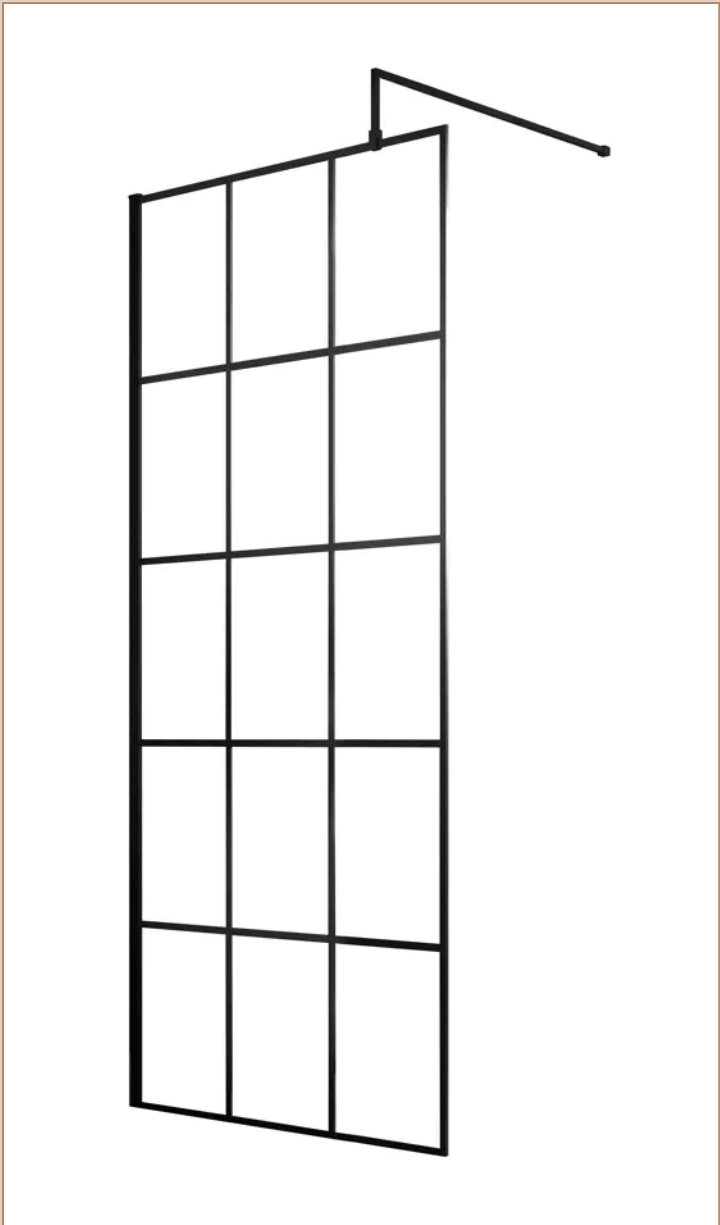

Product Dimensions

Product	1950 x 900 x 14mm (H x W x D)
Packaged	60 x 950 x 2070mm (H x W x D)
Nett Weight	40.3 kg
Packaged Weight	40.3 kg

Product Details

Country of Origin	China
Product Material	Aluminium
Colour/Finish	Matt Black
Style	Contemporary
Fixings Included	Yes
Easy Clean	Yes
Adjustment Max	893
Adjustment Min	875
Ce Certified	Yes
Declaration Of Performance	Yes
Easy Fit	No
Enclosure Design	Framed
Frame Finish	Matt Black
Glass Thickness	8 mm
Handles Included	No
Support Bar Included	Yes
Ukca Certified	Yes

Sales Code: NTP031

Barcode: 5055369071180

Brand: nuie

Description: 1400 x 700mm Rectangular Shower Tray

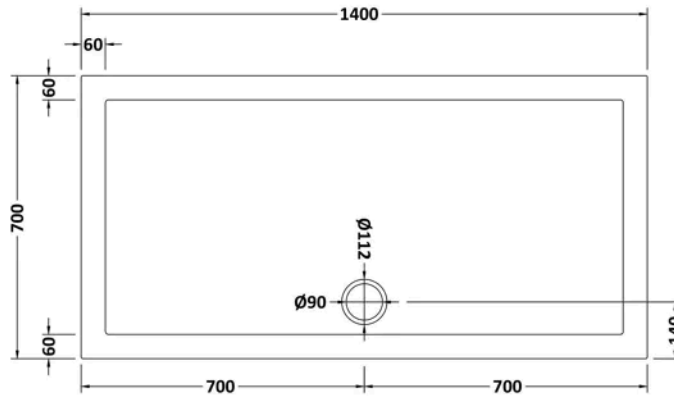

Product Dimensions

Product	40 x 700 x 1400mm (H x W x L)
Packaged	80 x 740 x 1440mm (H x W x D)
Nett Weight	30.8 kg
Packaged Weight	31.1 kg

Product Details

Country of Origin	United Kingdom
Product Material	Acrylic Capped Abs Caco3 And Pu
Colour/Finish	White
Style	Contemporary
Fixings Included	No
Ce Certified	Yes
Leg Set Included	No
Legs Included	No
Raised Edge	Yes
Slip Resistant	No
Waste Included	No
Waste Size Required	90mm

Sales Code: ENZW020

Barcode: 5056678428689

Brand: nuie

Description: nuie 900mm Framed Walk-In Wetroom Screen Set With Tray

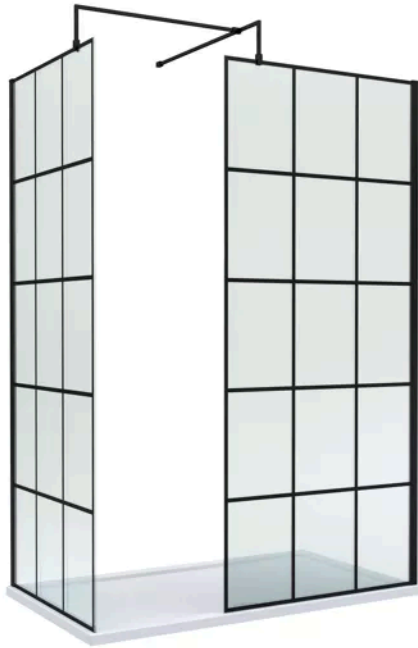

Technical Drawing Not Available

Product Dimensions

Product	1950 x 900 x 14mm (H x W x D)
Nett Weight	110.2 kg
Packaged Weight	110.2 kg

Product Details

Country of Origin	China
Product Material	Acrylic Capped Abs Caco3 And Pu,Aluminium,Glass
Colour/Finish	Matt Black
Style	Contemporary
Ce Certified	Yes
Enclosure Design	Framed
Glass Thickness	8 mm
Waste Included	No

Sales Code: WRSF080

Barcode: 5056211806905

Brand: Hudson Reed

Description: Hudson Reed 800mm Framed Matrix Matt Black Wetroom Screen

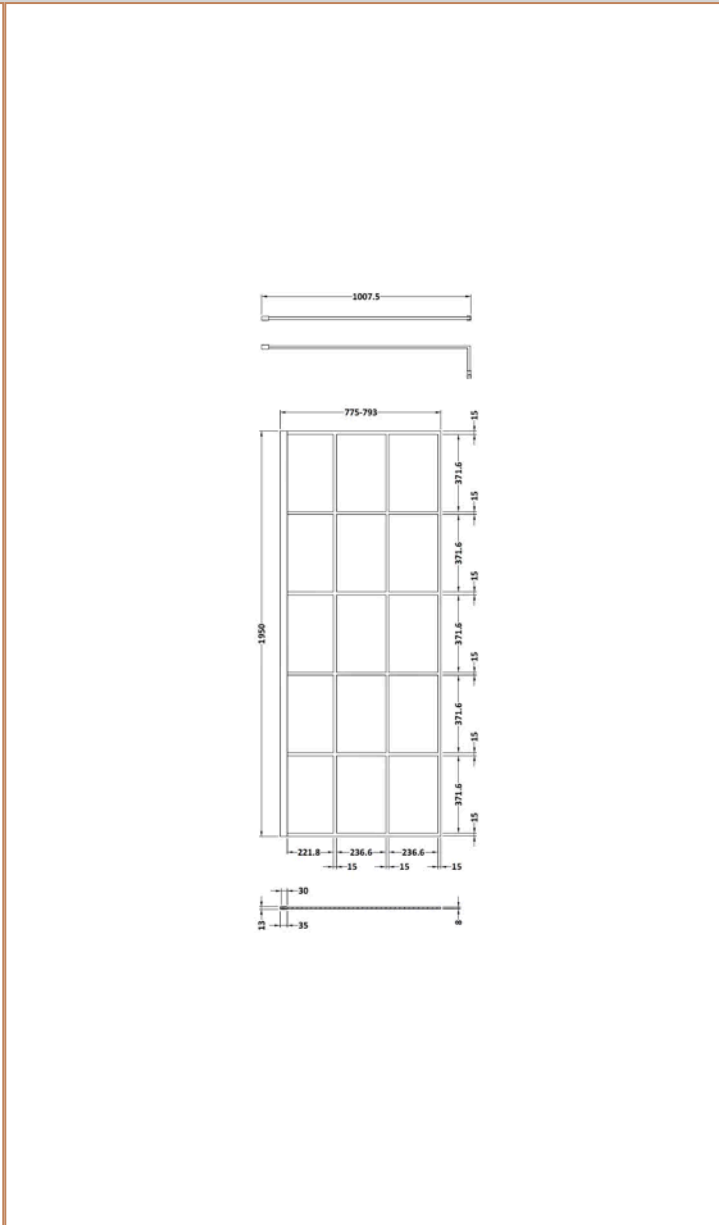
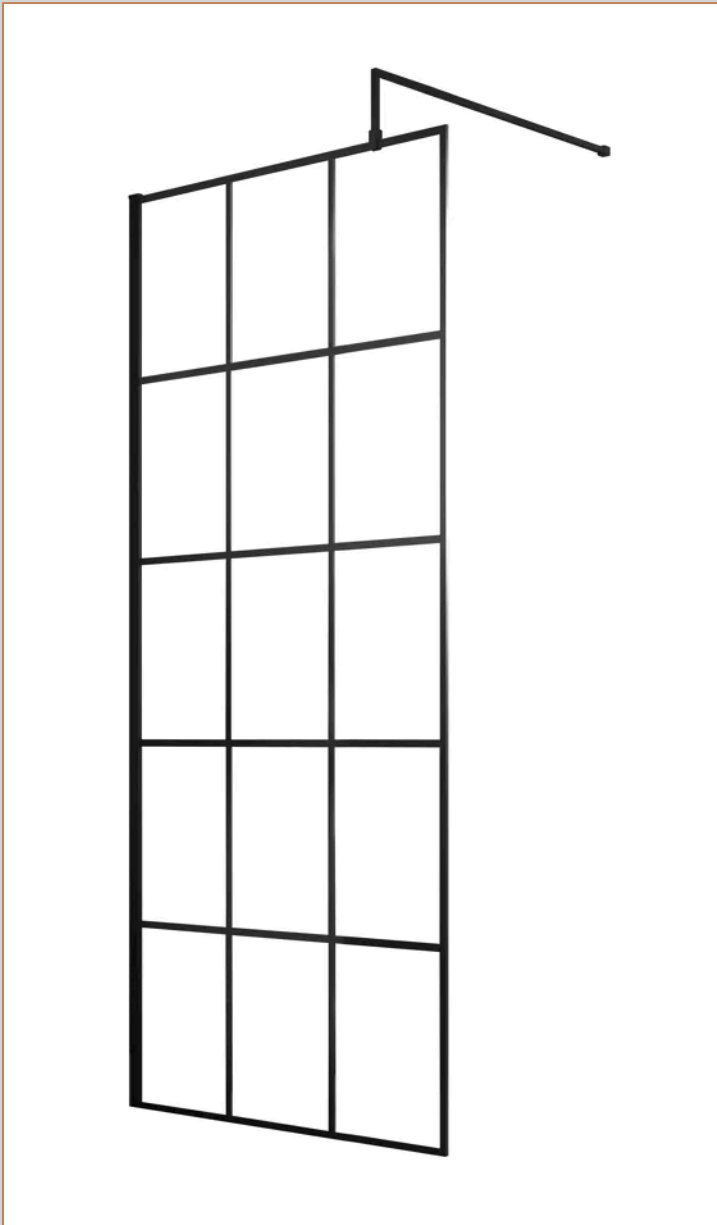

Product Dimensions

Product	1950 x 800 x 14mm (H x W x D)
Packaged	60 x 850 x 2070mm (H x W x D)
Nett Weight	35.9 kg
Packaged Weight	35.9 kg

Product Details

Country of Origin	China
Product Material	Aluminium
Colour/Finish	Matt Black
Style	Contemporary
Fixings Included	Yes
Easy Clean	Yes
Adjustment Max	793
Adjustment Min	775
Ce Certified	Yes
Declaration Of Performance	Yes
Easy Fit	No
Enclosure Design	Framed
Frame Finish	Matt Black
Glass Thickness	8 mm
Handles Included	No
Support Bar Included	Yes
Ukca Certified	Yes

Sales Code: WRSF090

Barcode: 5056211806912

Brand: Hudson Reed

Description: Hudson Reed 900mm Matt Black Matrix Framed Wetroom Screen

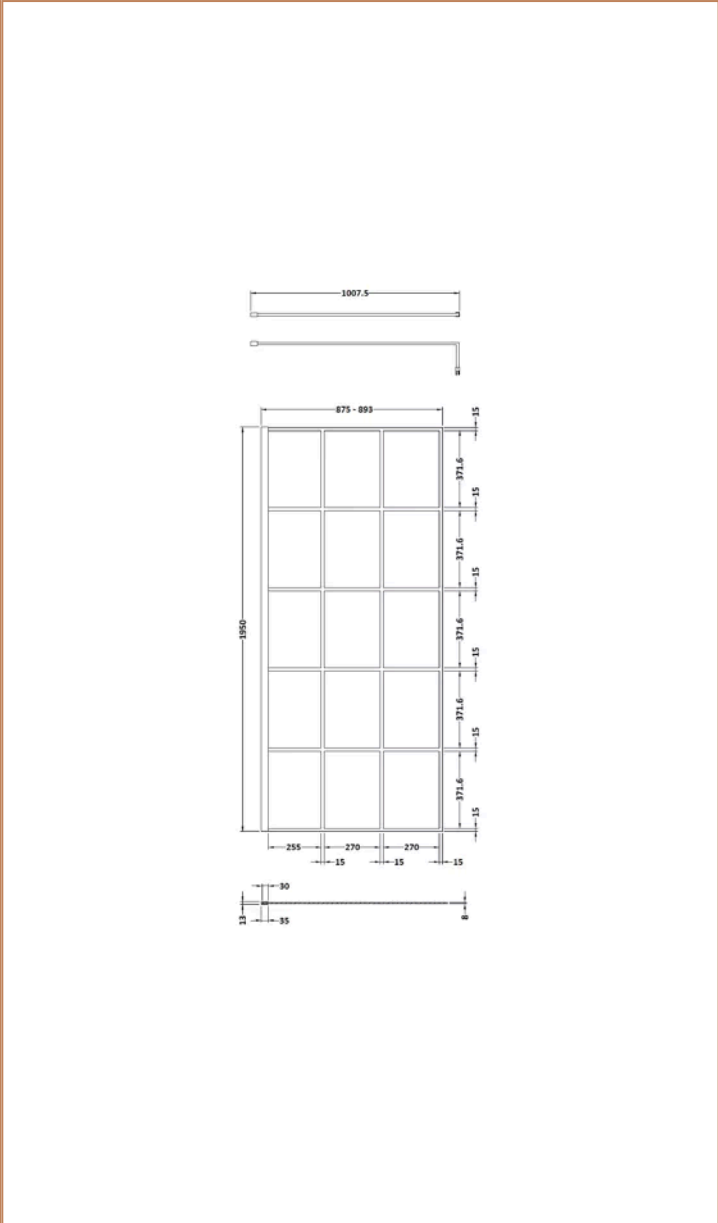
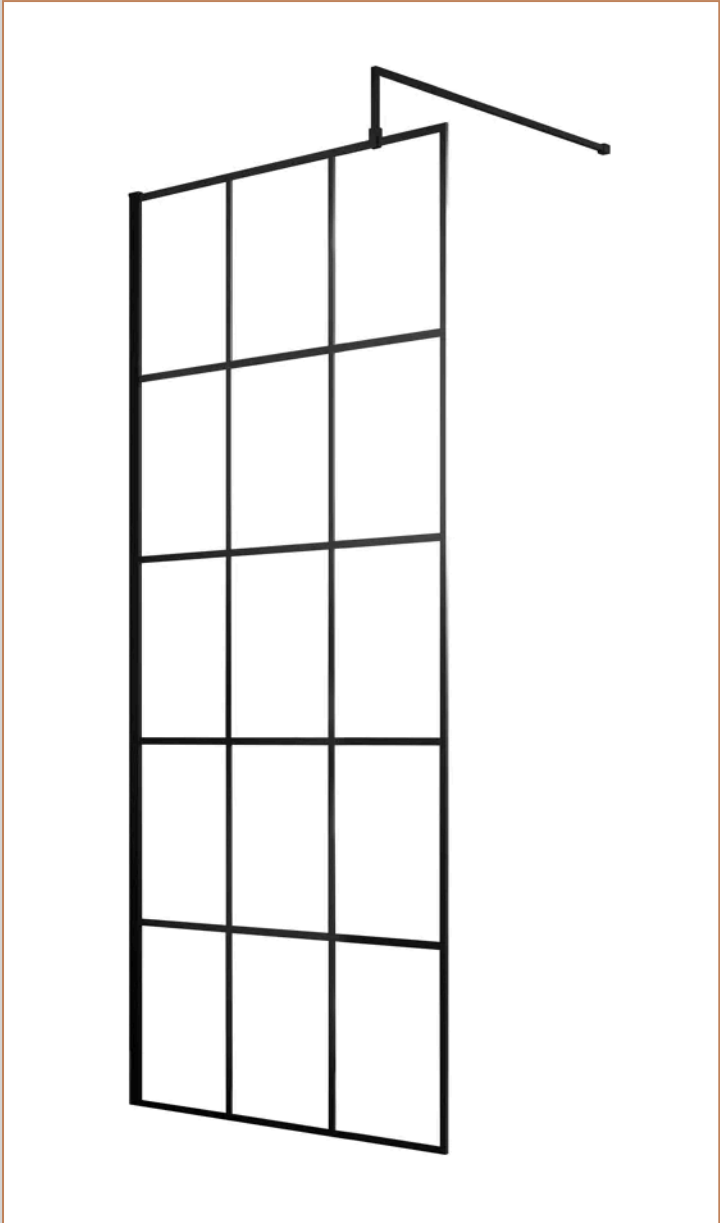

Product Dimensions

Product	1950 x 900 x 14mm (H x W x D)
Packaged	60 x 950 x 2070mm (H x W x D)
Nett Weight	40.3 kg
Packaged Weight	40.3 kg

Product Details

Country of Origin	China
Product Material	Aluminium
Colour/Finish	Matt Black
Style	Contemporary
Fixings Included	Yes
Easy Clean	Yes
Adjustment Max	893
Adjustment Min	875
Ce Certified	Yes
Declaration Of Performance	Yes
Easy Fit	No
Enclosure Design	Framed
Frame Finish	Matt Black
Glass Thickness	8 mm
Handles Included	No
Support Bar Included	Yes
Ukca Certified	Yes

Sales Code: NTP033

Barcode: 5055369006335

Brand: nuie

Description: 1400 x 800mm Rectangular Slimline Shower Tray

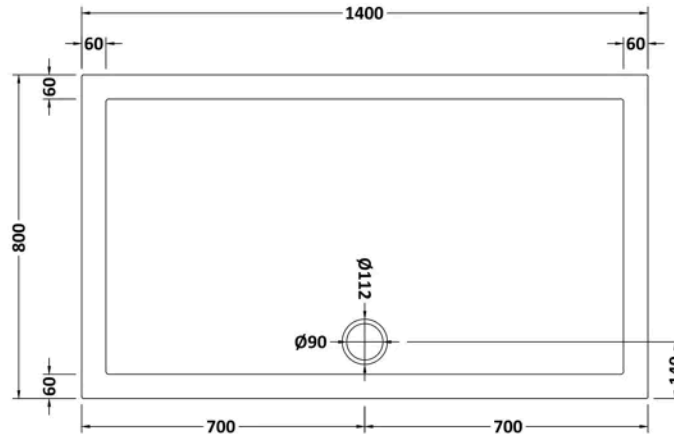

Product Dimensions

Product	40 x 800 x 1400mm (H x W x L)
Packaged	80 x 840 x 1440mm (H x W x D)
Nett Weight	36.6 kg
Packaged Weight	36.9 kg

Product Details

Country of Origin	United Kingdom
Product Material	Acrylic Capped Abs Caco3 And Pu
Colour/Finish	White
Style	Contemporary
Fixings Included	No
Ce Certified	Yes
Leg Set Included	No
Legs Included	No
Raised Edge	Yes
Slip Resistant	No
Waste Included	No
Waste Size Required	90mm

Sales Code: ENZW027

Barcode: 5056678428610

Brand: nuie

Description: nuie 900mm Walk-In Matt Black Wetroom Screen Set With Tray

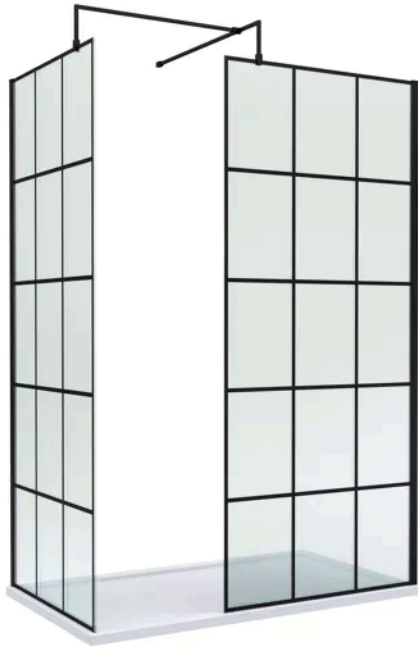

Technical Drawing Not Available

Product Dimensions

Product	1950 x 900 x 14mm (H x W x D)
Nett Weight	112 kg
Packaged Weight	112 kg

Product Details

Country of Origin	China
Product Material	Acrylic Capped Abs Caco3 And Pu,Aluminium,Glass
Colour/Finish	Matt Black
Style	Contemporary
Ce Certified	Yes
Glass Thickness	8 mm
Waste Included	No

Sales Code: WRSF090

Barcode: 5056211806912

Brand: Hudson Reed

Description: Hudson Reed 900mm Matt Black Matrix Framed Wetroom Screen

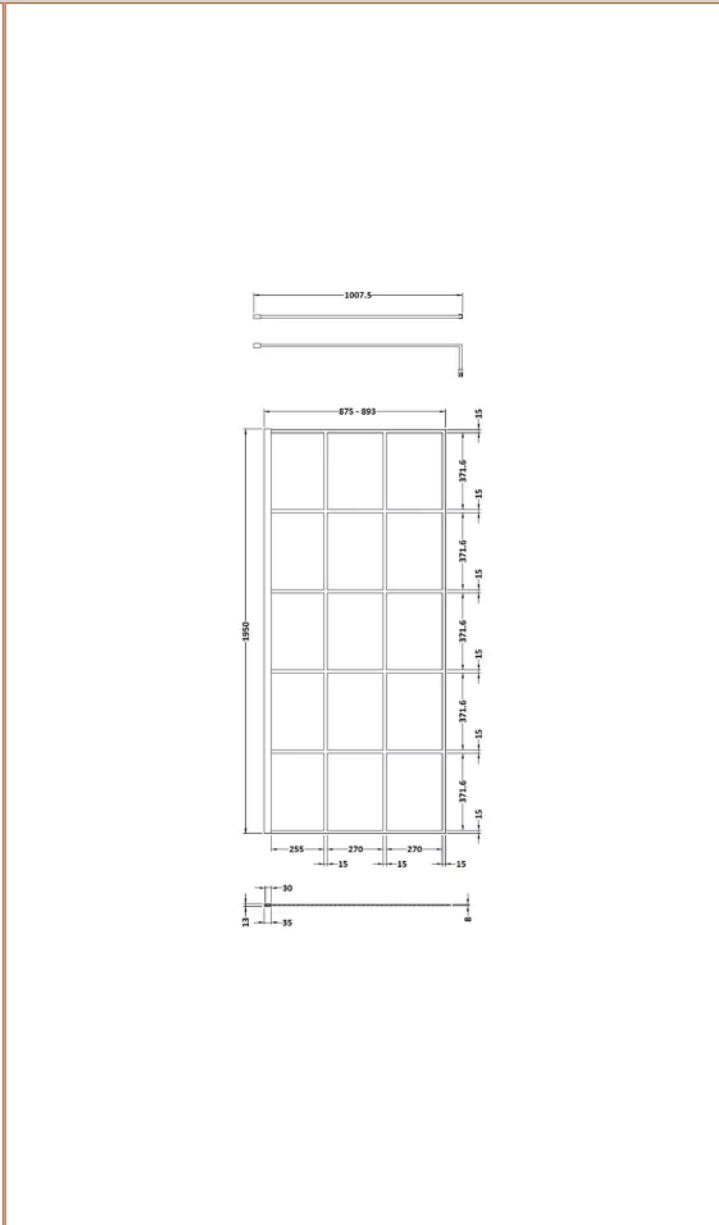
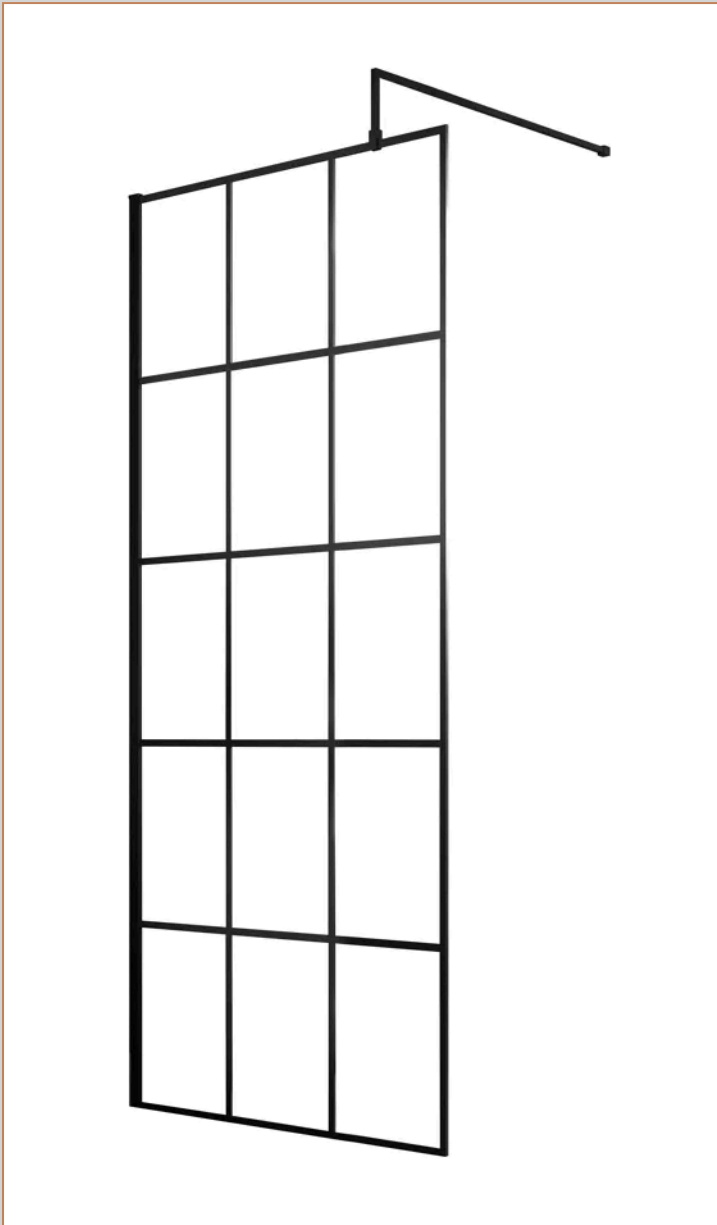

Product Dimensions

Product	1950 x 900 x 14mm (H x W x D)
Packaged	60 x 950 x 2070mm (H x W x D)
Nett Weight	40.3 kg
Packaged Weight	40.3 kg

Product Details

Country of Origin	China
Product Material	Aluminium
Colour/Finish	Matt Black
Style	Contemporary
Fixings Included	Yes
Easy Clean	Yes
Adjustment Max	893
Adjustment Min	875
Ce Certified	Yes
Declaration Of Performance	Yes
Easy Fit	No
Enclosure Design	Framed
Frame Finish	Matt Black
Glass Thickness	8 mm
Handles Included	No
Support Bar Included	Yes
Ukca Certified	Yes

Sales Code: NTP034

Barcode: 5055369006342

Brand: nuie

Description: 1400 x 900mm Rectangular Slimline Shower Tray

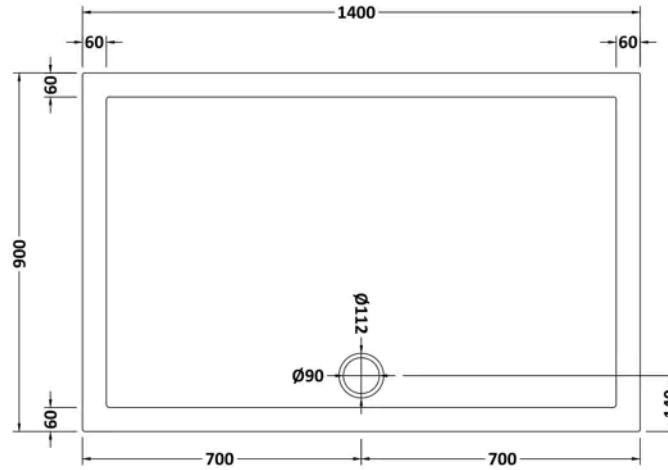

Product Dimensions

Product	40 x 900 x 1400mm (H x W x L)
Packaged	80 x 940 x 1440mm (H x W x D)
Nett Weight	36.8 kg
Packaged Weight	37.1 kg

Product Details

Country of Origin	United Kingdom
Product Material	Acrylic Capped Abs Caco3 And Pu
Colour/Finish	White
Style	Contemporary
Fixings Included	No
Ce Certified	Yes
Leg Set Included	No
Legs Included	No
Raised Edge	Yes
Slip Resistant	No
Waste Included	No
Waste Size Required	90mm

Sales Code: ENZW034

Barcode: 5056678428542

Brand: nuie

Description: nuie 1200mm Framed Walk-In Wetroom Screen Set With Tray



Technical Drawing Not Available

Product Dimensions

Product	1950 x 1200 x 14mm (H x W x D)
Nett Weight	116.5 kg
Packaged Weight	116.5 kg

Product Details

Country of Origin	China
Product Material	Acrylic Capped Abs Caco3 And Pu,Aluminium,Glass
Colour/Finish	Matt Black
Style	Contemporary
Ce Certified	Yes
Enclosure Design	Framed
Glass Thickness	8 mm
Waste Included	No

Sales Code: WRSF070

Barcode: 5056211806882

Brand: Hudson Reed

Description: Hudson Reed 700mm Framed Matrix Matt Black Wetroom Screen

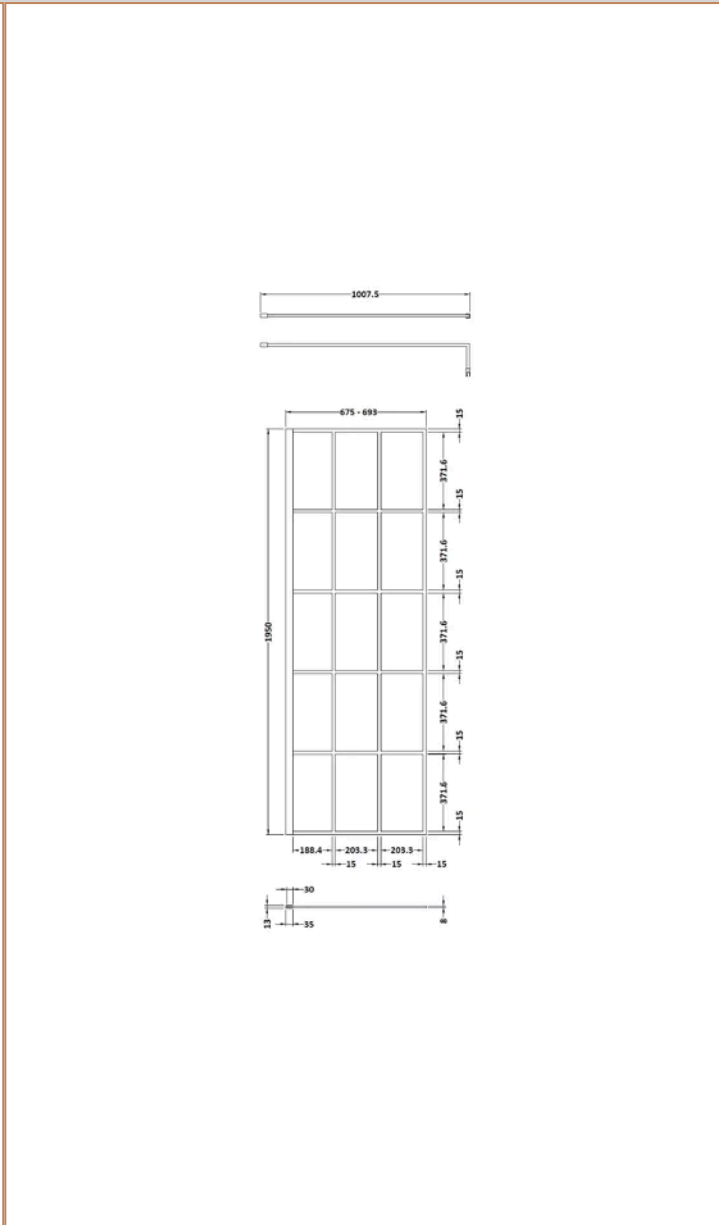
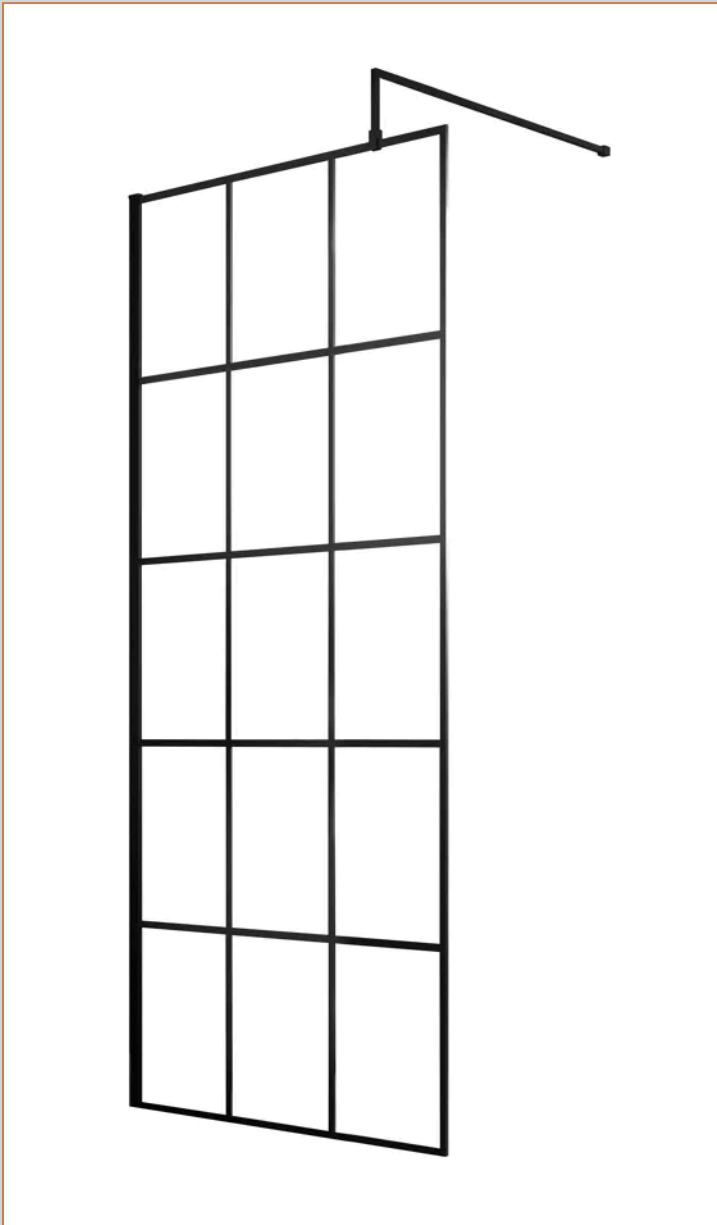

Product Dimensions

Product	1950 x 700 x 14mm (H x W x D)
Packaged	60 x 750 x 2070mm (H x W x D)
Nett Weight	31.1 kg
Packaged Weight	31.1 kg

Product Details

Country of Origin	China
Product Material	Aluminium
Colour/Finish	Matt Black
Style	Contemporary
Fixings Included	Yes
Easy Clean	Yes
Adjustment Max	693
Adjustment Min	675
Ce Certified	Yes
Declaration Of Performance	Yes
Easy Fit	No
Enclosure Design	Framed
Frame Finish	Matt Black
Glass Thickness	8 mm
Handles Included	No
Support Bar Included	Yes
Ukca Certified	Yes

Sales Code: WRSF12

Barcode: 5056211806943

Brand: Hudson Reed

Description: Hudson Reed 1200mm Matt Black Matrix Framed Wetroom Screen

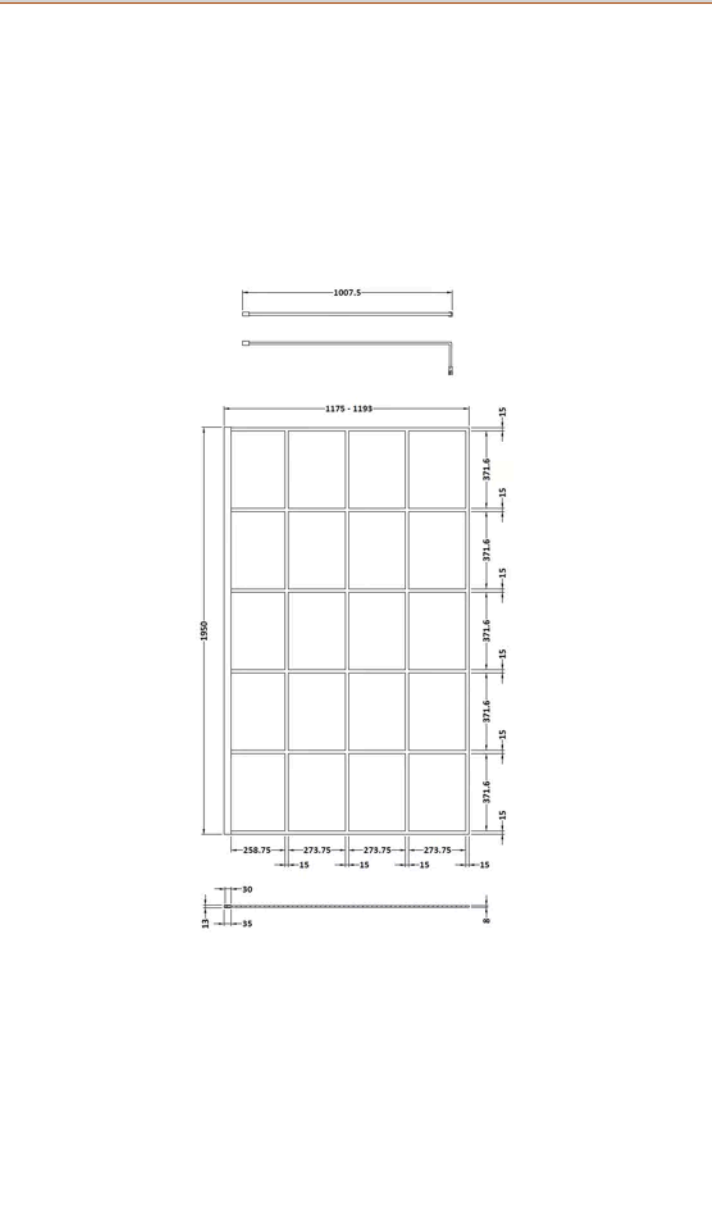
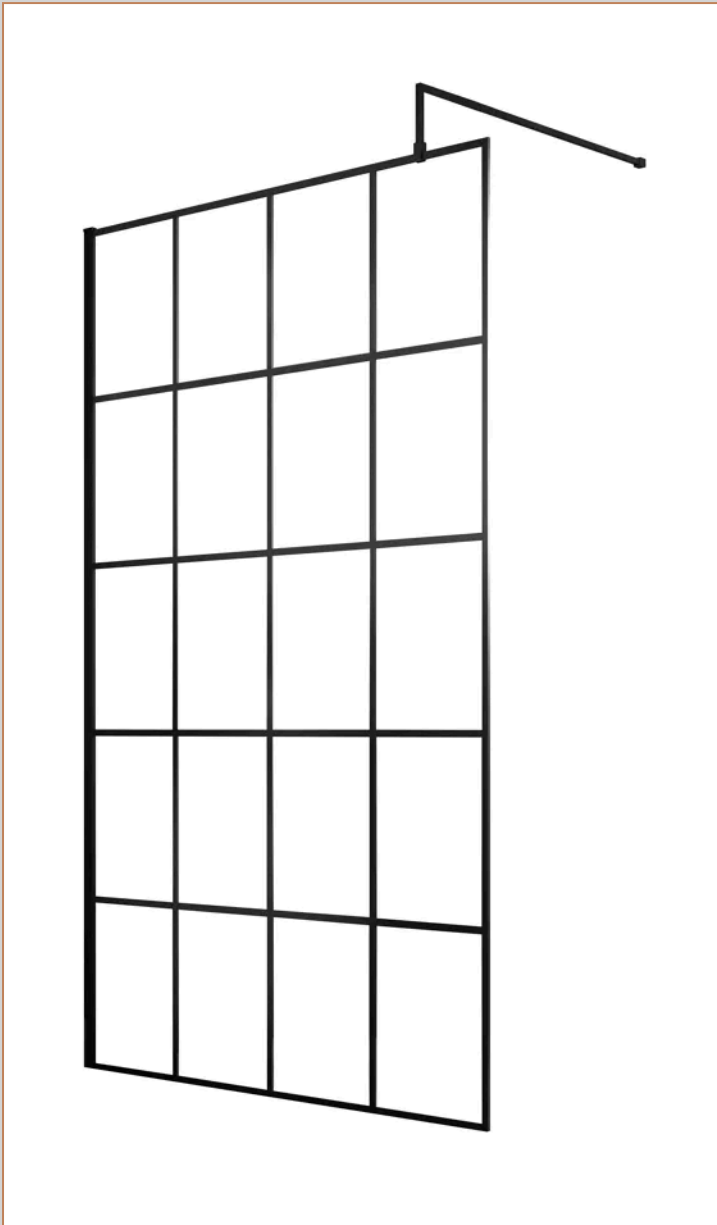

Product Dimensions

Product	1950 x 1200 x 14mm (H x W x D)
Packaged	60 x 1250 x 2070mm (H x W x D)
Nett Weight	53.2 kg
Packaged Weight	53.2 kg

Product Details

Country of Origin	China
Product Material	Aluminium
Colour/Finish	Matt Black
Style	Contemporary
Fixings Included	Yes
Easy Clean	Yes
Adjustment Max	1193
Adjustment Min	1175
Ce Certified	Yes
Declaration Of Performance	Yes
Easy Fit	No
Enclosure Design	Framed
Frame Finish	Matt Black
Glass Thickness	8 mm
Handles Included	No
Support Bar Included	Yes
Ukca Certified	Yes

Sales Code: NTP061

Barcode: 5055369006373

Brand: nuie

Description: 1700 x 700mm Rectangular Slimline Shower Tray

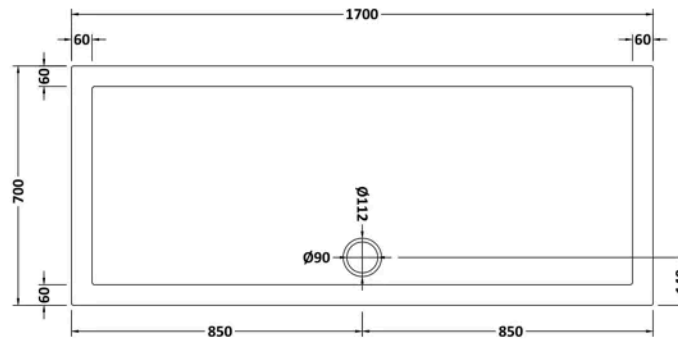

Product Dimensions

Product	40 x 700 x 1700mm (H x W x L)
Packaged	80 x 740 x 1740mm (H x W x D)
Nett Weight	37.8 kg
Packaged Weight	38.1 kg

Product Details

Country of Origin	United Kingdom
Product Material	Acrylic Capped Abs Caco3 And Pu
Colour/Finish	White
Style	Contemporary
Fixings Included	No
Ce Certified	Yes
Leg Set Included	No
Legs Included	No
Raised Edge	Yes
Slip Resistant	No
Waste Included	No
Waste Size Required	90mm

Sales Code: ENZW038

Barcode: 5056678428504

Brand: nuie

Description: nuie 800mm Framed Walk-In Wetroom Screen Set With Tray



Technical Drawing Not Available

Product Dimensions

Product	1950 x 800 x 14mm (H x W x D)
Nett Weight	124.2 kg
Packaged Weight	124.2 kg

Product Details

Country of Origin	China
Product Material	Acrylic Capped Abs Caco3 And Pu,Aluminium,Glass
Colour/Finish	Matt Black
Style	Contemporary
Ce Certified	Yes
Enclosure Design	Framed
Glass Thickness	8 mm
Waste Included	No

Sales Code: WRSF080

Barcode: 5056211806905

Brand: Hudson Reed

Description: Hudson Reed 800mm Framed Matrix Matt Black Wetroom Screen

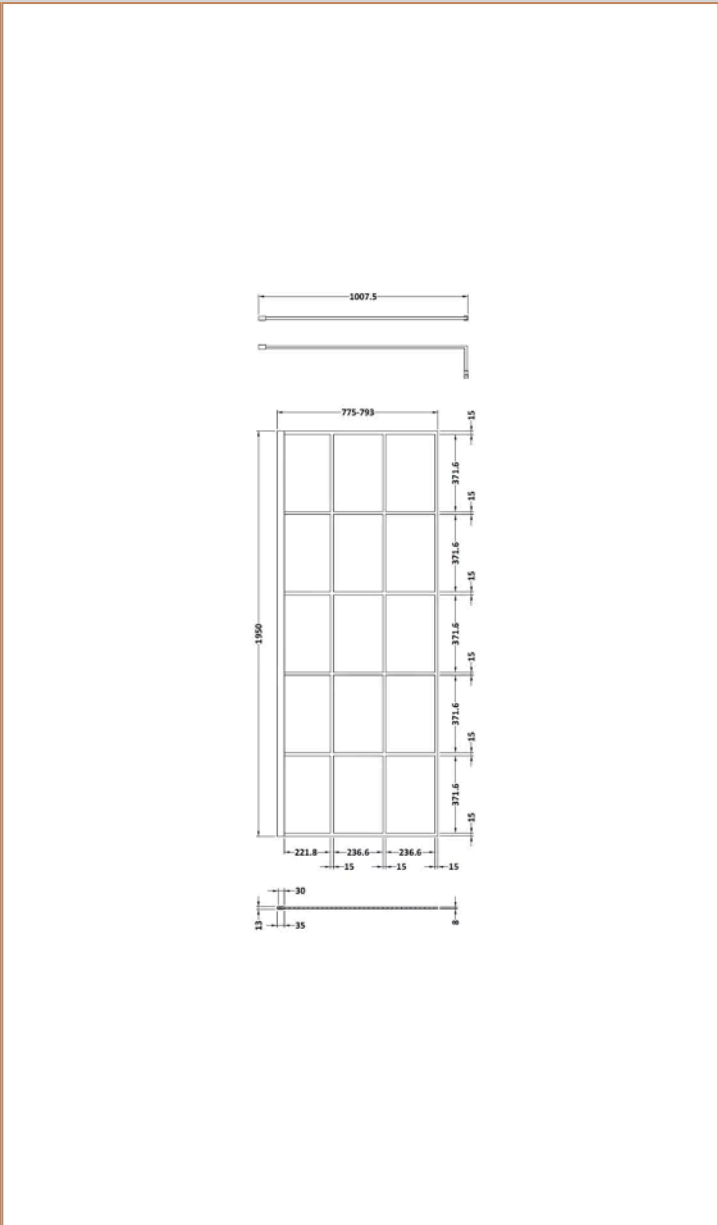
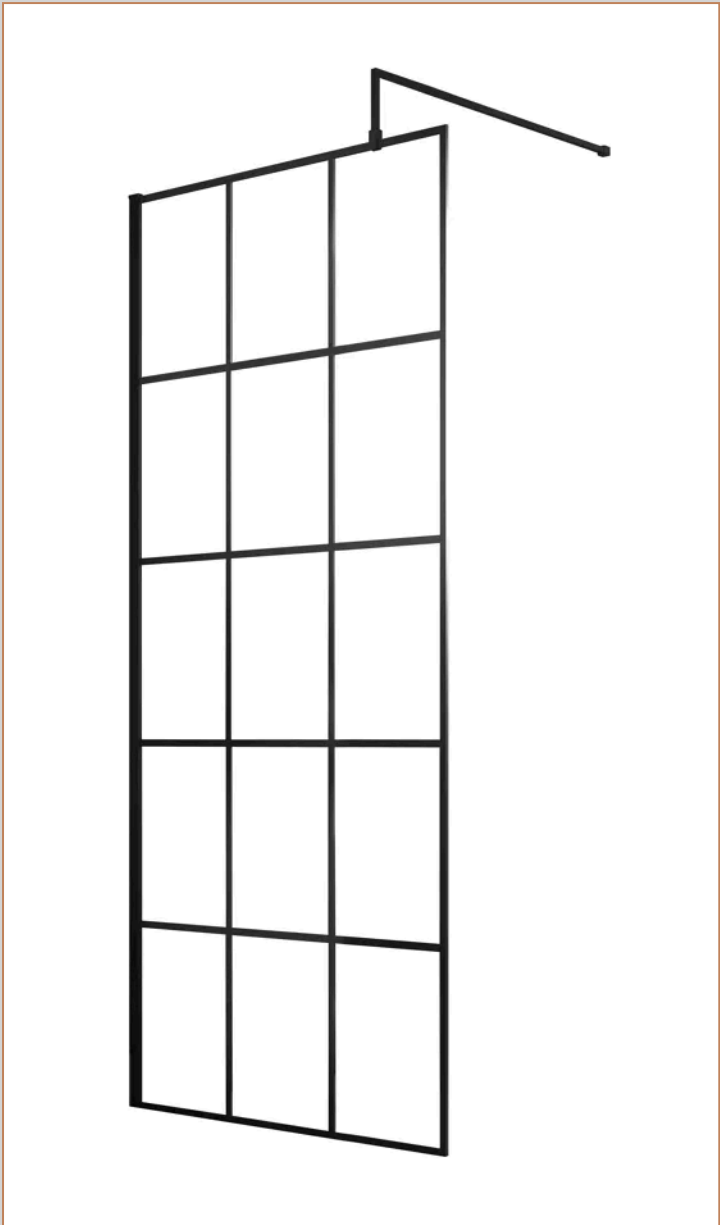

Product Dimensions

Product	1950 x 800 x 14mm (H x W x D)
Packaged	60 x 850 x 2070mm (H x W x D)
Nett Weight	35.9 kg
Packaged Weight	35.9 kg

Product Details

Country of Origin	China
Product Material	Aluminium
Colour/Finish	Matt Black
Style	Contemporary
Fixings Included	Yes
Easy Clean	Yes
Adjustment Max	793
Adjustment Min	775
Ce Certified	Yes
Declaration Of Performance	Yes
Easy Fit	No
Enclosure Design	Framed
Frame Finish	Matt Black
Glass Thickness	8 mm
Handles Included	No
Support Bar Included	Yes
Ukca Certified	Yes

Sales Code: WRSF12

Barcode: 5056211806943

Brand: Hudson Reed

Description: Hudson Reed 1200mm Matt Black Matrix Framed Wetroom Screen

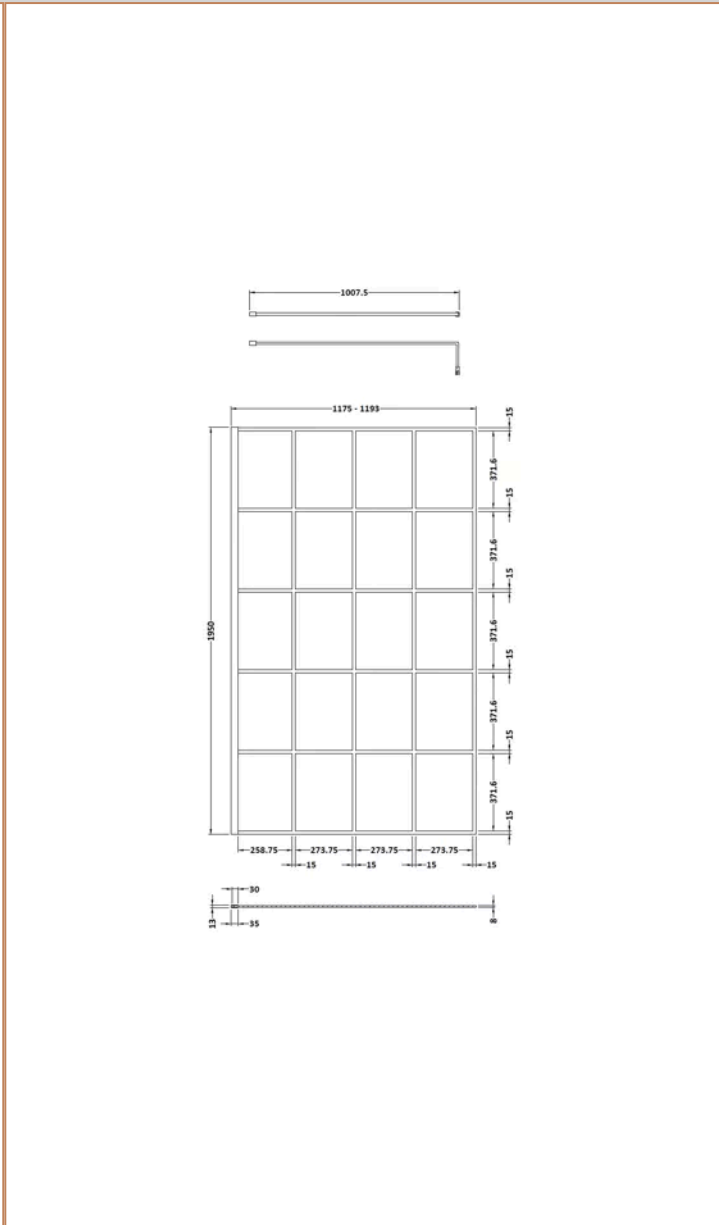
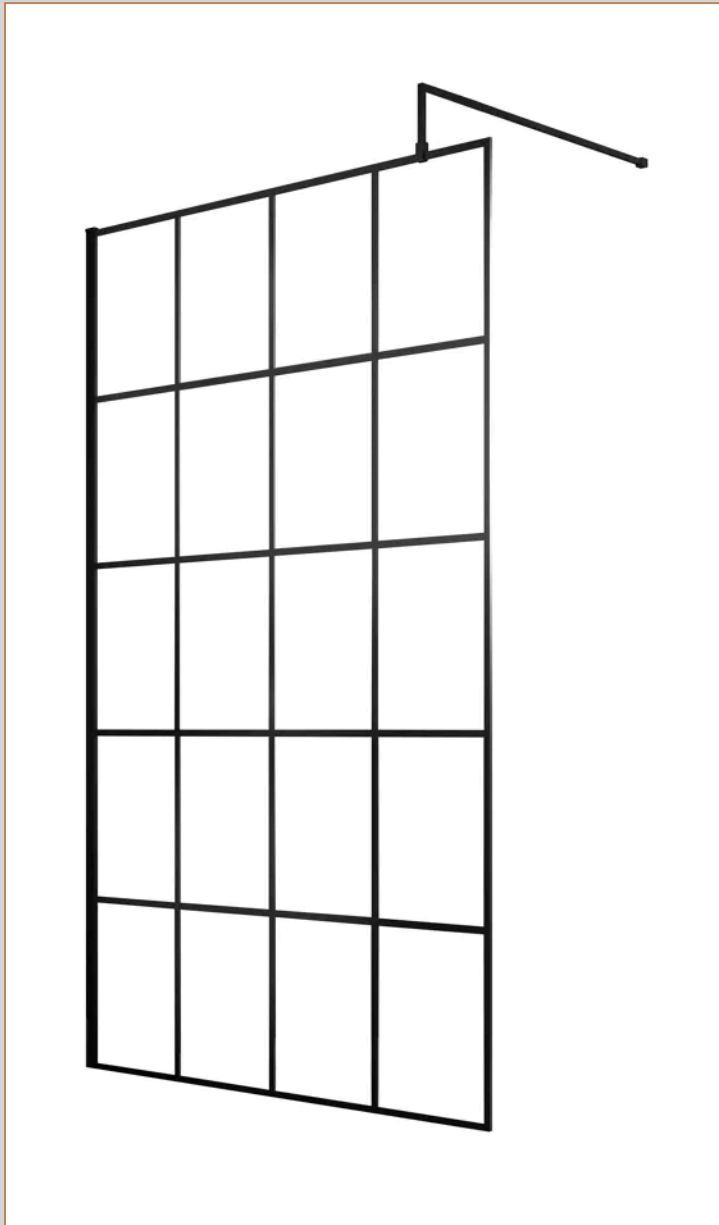

Product Dimensions

Product	1950 x 1200 x 14mm (H x W x D)
Packaged	60 x 1250 x 2070mm (H x W x D)
Nett Weight	53.2 kg
Packaged Weight	53.2 kg

Product Details

Country of Origin	China
Product Material	Aluminium
Colour/Finish	Matt Black
Style	Contemporary
Fixings Included	Yes
Easy Clean	Yes
Adjustment Max	1193
Adjustment Min	1175
Ce Certified	Yes
Declaration Of Performance	Yes
Easy Fit	No
Enclosure Design	Framed
Frame Finish	Matt Black
Glass Thickness	8 mm
Handles Included	No
Support Bar Included	Yes
Ukca Certified	Yes

Sales Code: NTP063

Barcode: 5055369006380

Brand: nuie

Description: 1700 x 800mm Rectangular Slimline Shower Tray

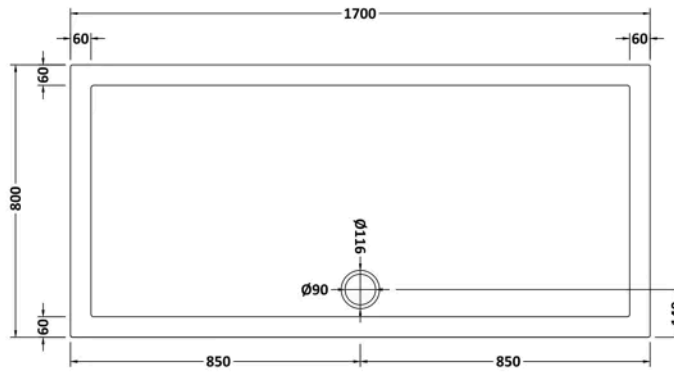

Product Dimensions

Product	40 x 800 x 1700mm (H x W x L)
Packaged	80 x 840 x 1740mm (H x W x D)
Nett Weight	43.2 kg
Packaged Weight	43.5 kg

Product Details

Country of Origin	United Kingdom
Product Material	Acrylic Capped Abs Caco3 And Pu
Colour/Finish	White
Style	Contemporary
Fixings Included	No
Ce Certified	Yes
Leg Set Included	No
Legs Included	No
Raised Edge	Yes
Slip Resistant	No
Waste Included	No
Waste Size Required	90mm

Sales Code: ENZW042

Barcode: 5056678428467

Brand: nuie

Description: nuie 900mm Framed Walk-In Wetroom Screen Set With Tray



Technical Drawing Not Available

Product Dimensions

Product	1950 x 900 x 14mm (H x W x D)
Nett Weight	135.1 kg
Packaged Weight	135.1 kg

Product Details

Country of Origin	China
Product Material	Acrylic Capped Abs Caco3 And Pu,Aluminium,Glass
Colour/Finish	Matt Black
Style	Contemporary
Ce Certified	Yes
Enclosure Design	Framed
Glass Thickness	8 mm
Waste Included	No

Sales Code: WRSF090

Barcode: 5056211806912

Brand: Hudson Reed

Description: Hudson Reed 900mm Matt Black Matrix Framed Wetroom Screen

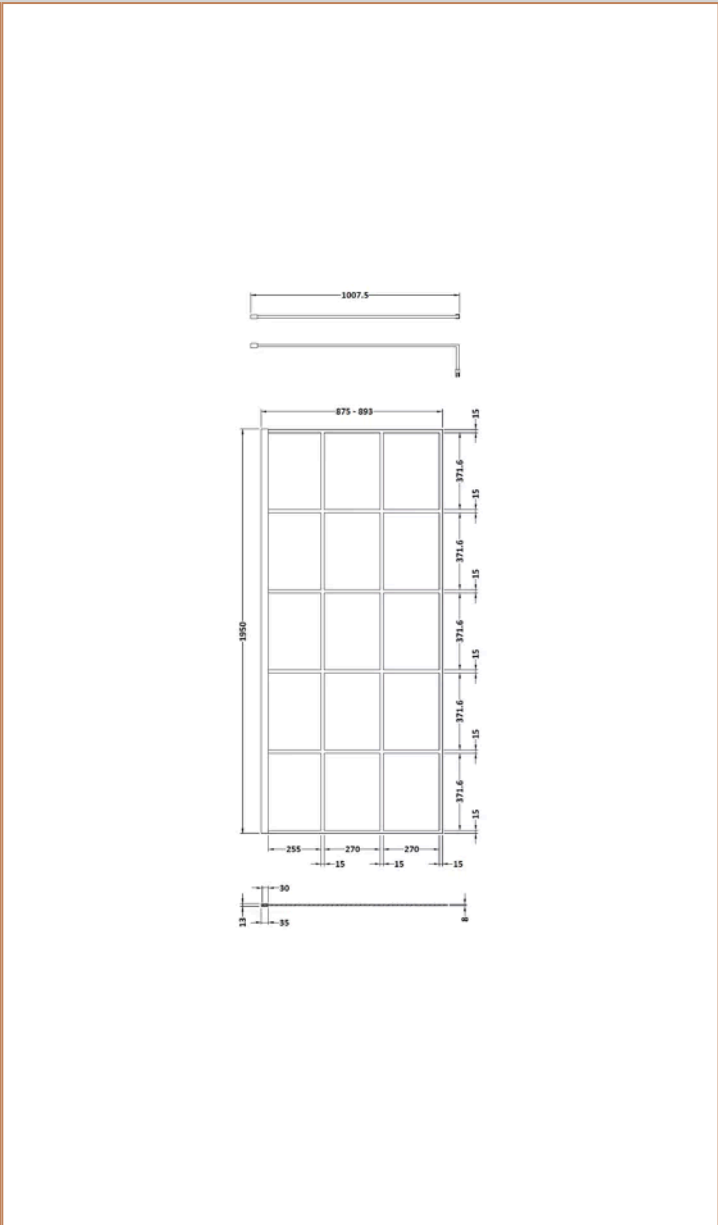
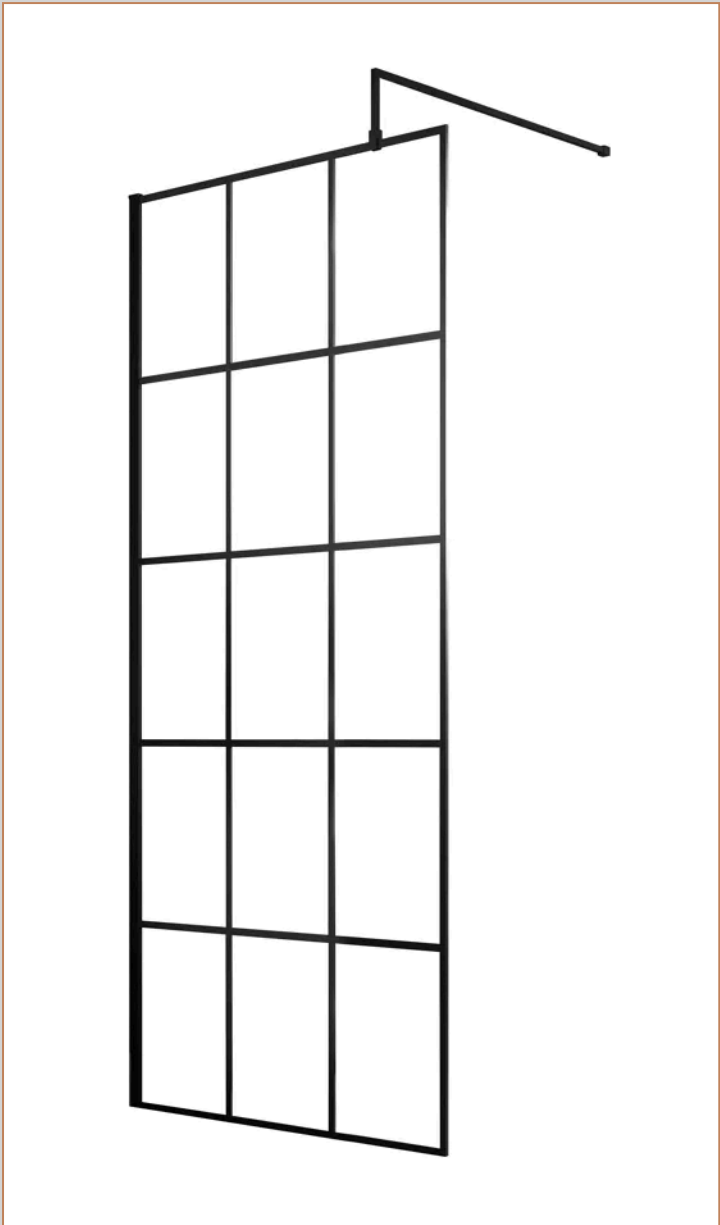

Product Dimensions

Product	1950 x 900 x 14mm (H x W x D)
Packaged	60 x 950 x 2070mm (H x W x D)
Nett Weight	40.3 kg
Packaged Weight	40.3 kg

Product Details

Country of Origin	China
Product Material	Aluminium
Colour/Finish	Matt Black
Style	Contemporary
Fixings Included	Yes
Easy Clean	Yes
Adjustment Max	893
Adjustment Min	875
Ce Certified	Yes
Declaration Of Performance	Yes
Easy Fit	No
Enclosure Design	Framed
Frame Finish	Matt Black
Glass Thickness	8 mm
Handles Included	No
Support Bar Included	Yes
Ukca Certified	Yes

Sales Code: WRSF12

Barcode: 5056211806943

Brand: Hudson Reed

Description: Hudson Reed 1200mm Matt Black Matrix Framed Wetroom Screen

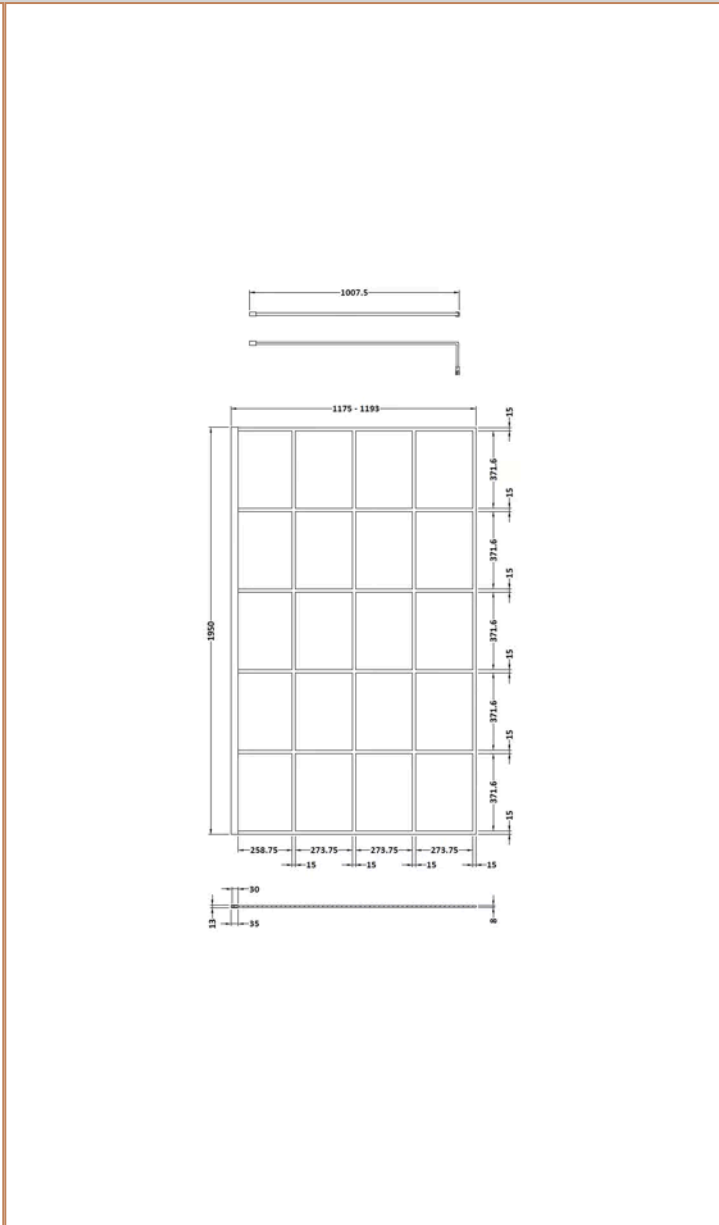
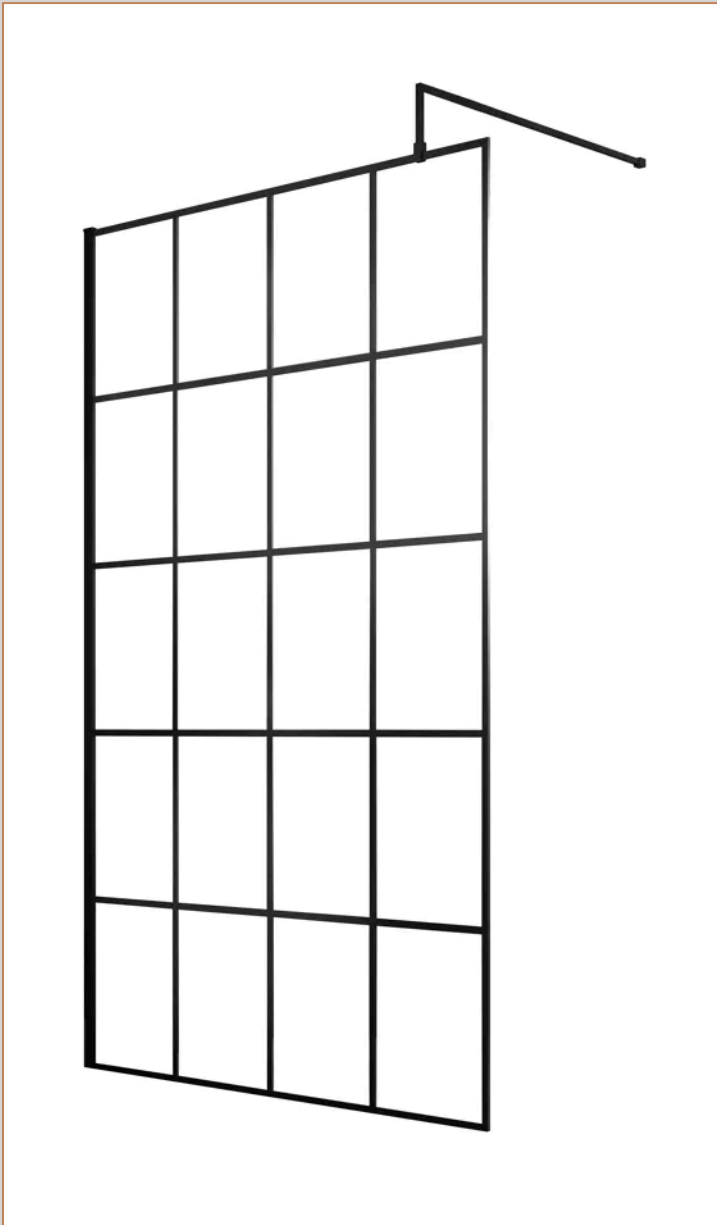

Product Dimensions

Product	1950 x 1200 x 14mm (H x W x D)
Packaged	60 x 1250 x 2070mm (H x W x D)
Nett Weight	53.2 kg
Packaged Weight	53.2 kg

Product Details

Country of Origin	China
Product Material	Aluminium
Colour/Finish	Matt Black
Style	Contemporary
Fixings Included	Yes
Easy Clean	Yes
Adjustment Max	1193
Adjustment Min	1175
Ce Certified	Yes
Declaration Of Performance	Yes
Easy Fit	No
Enclosure Design	Framed
Frame Finish	Matt Black
Glass Thickness	8 mm
Handles Included	No
Support Bar Included	Yes
Ukca Certified	Yes

Sales Code: NTP064

Barcode: 5055275869130

Brand: nuie

Description: 1700 x 900mm Rectangular Shower Tray

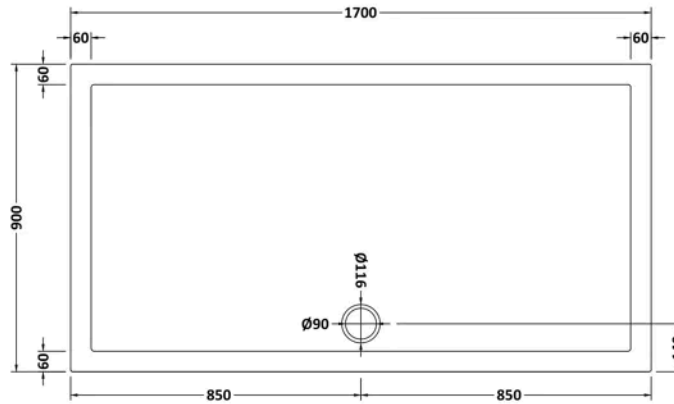

Product Dimensions

Product	40 x 900 x 1700mm (H x W x L)
Packaged	80 x 940 x 1740mm (H x W x D)
Nett Weight	50.5 kg
Packaged Weight	50.8 kg

Product Details

Country of Origin	United Kingdom
Product Material	Acrylic Capped Abs Caco3 And Pu
Colour/Finish	White
Style	Contemporary
Fixings Included	No
Ce Certified	Yes
Leg Set Included	No
Legs Included	No
Raised Edge	Yes
Slip Resistant	No
Waste Included	No
Waste Size Required	90mm

Sales Code: ENZW012

Barcode: 5056678428764

Brand: nuie

Description: nuie 900mm Framed Walk-In Wetroom Screen Set With Tray



Technical Drawing Not Available

Product Dimensions

Product	1950 x 900 x 14mm (H x W x D)
Nett Weight	98.8 kg
Packaged Weight	98.8 kg

Product Details

Country of Origin	China
Product Material	Acrylic Capped Abs Caco3 And Pu,Aluminium,Glass
Colour/Finish	Matt Black
Style	Contemporary
Ce Certified	Yes
Enclosure Design	Framed
Glass Thickness	8 mm
Waste Included	No

Sales Code: WRSF070

Barcode: 5056211806882

Brand: Hudson Reed

Description: Hudson Reed 700mm Framed Matrix Matt Black Wetroom Screen

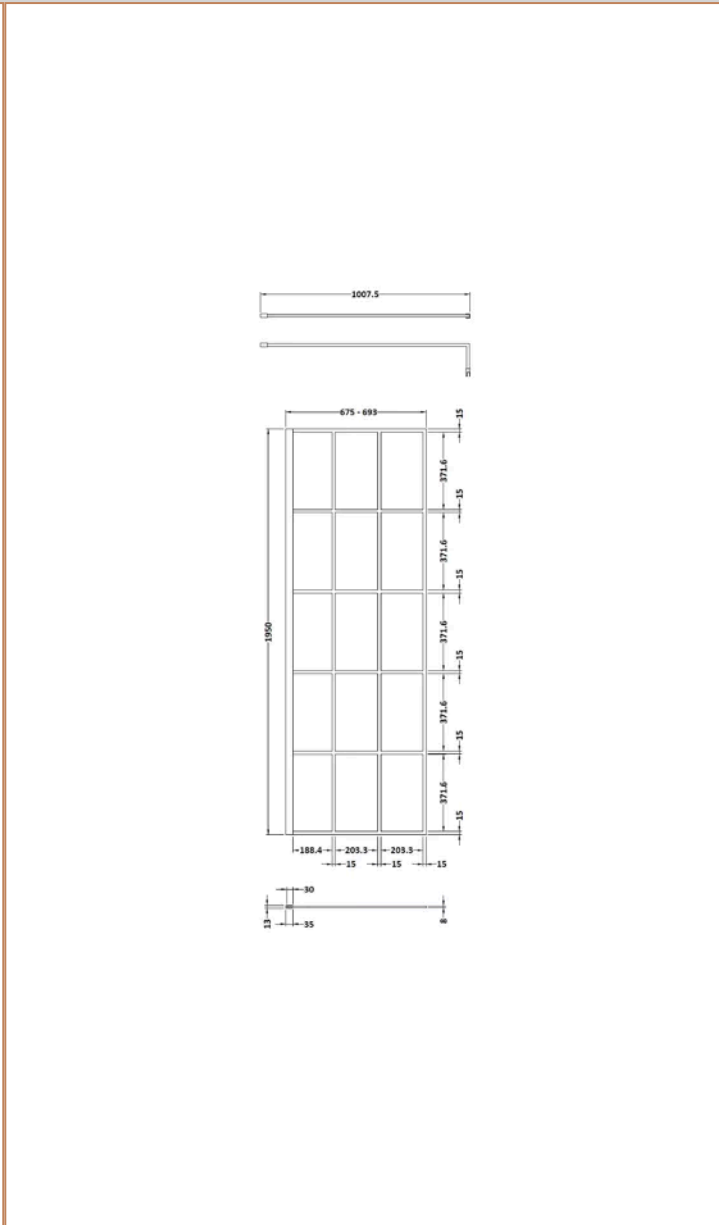
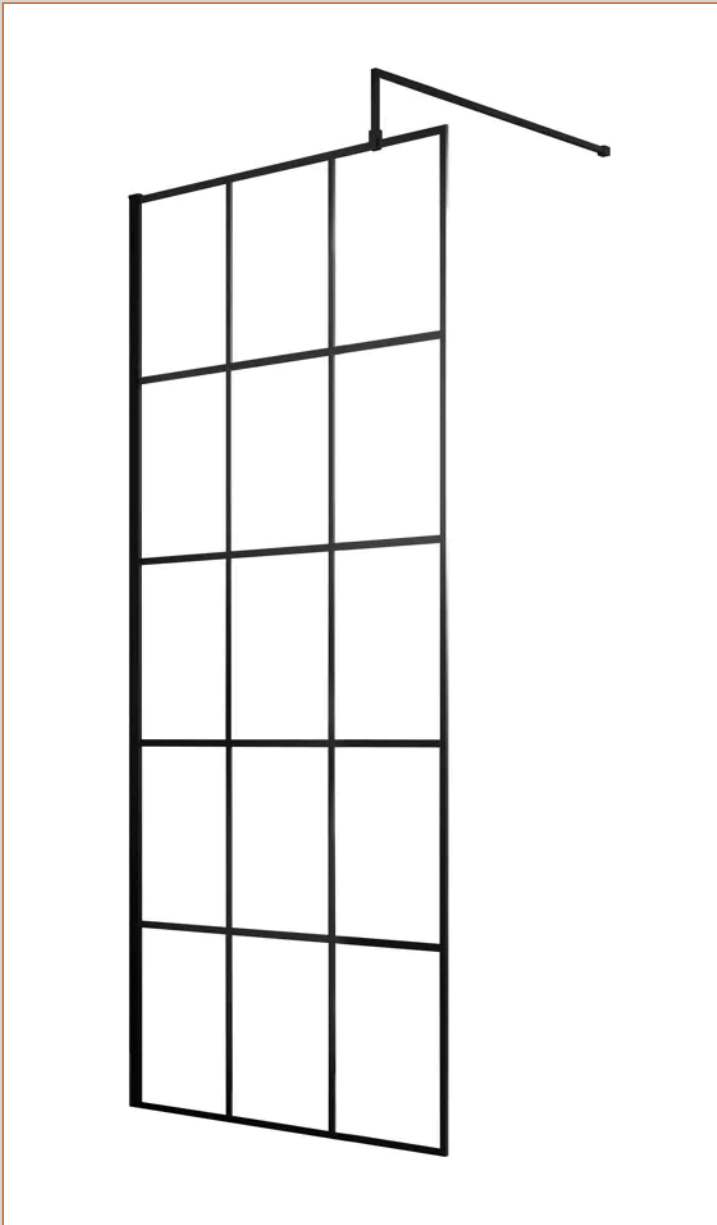

Product Dimensions

Product	1950 x 700 x 14mm (H x W x D)
Packaged	60 x 750 x 2070mm (H x W x D)
Nett Weight	31.1 kg
Packaged Weight	31.1 kg

Product Details

Country of Origin	China
Product Material	Aluminium
Colour/Finish	Matt Black
Style	Contemporary
Fixings Included	Yes
Easy Clean	Yes
Adjustment Max	693
Adjustment Min	675
Ce Certified	Yes
Declaration Of Performance	Yes
Easy Fit	No
Enclosure Design	Framed
Frame Finish	Matt Black
Glass Thickness	8 mm
Handles Included	No
Support Bar Included	Yes
Ukca Certified	Yes

Sales Code: WRSF090

Barcode: 5056211806912

Brand: Hudson Reed

Description: Hudson Reed 900mm Matt Black Matrix Framed Wetroom Screen

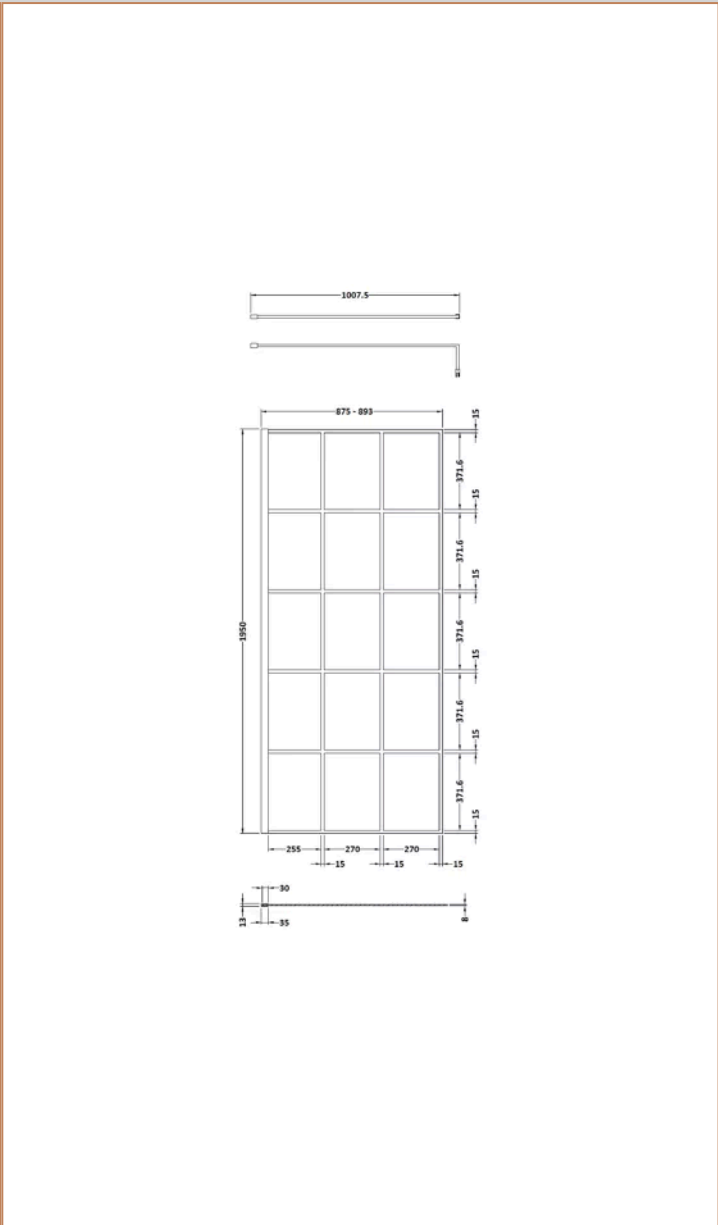
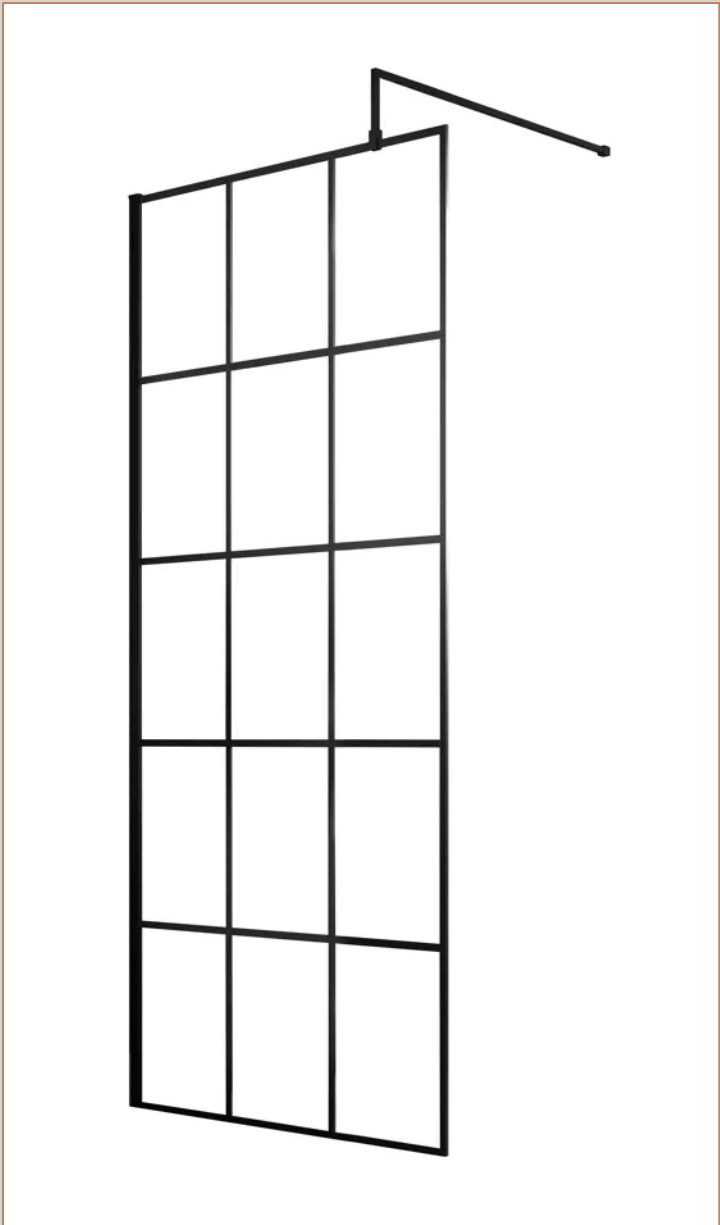

Product Dimensions

Product	1950 x 900 x 14mm (H x W x D)
Packaged	60 x 950 x 2070mm (H x W x D)
Nett Weight	40.3 kg
Packaged Weight	40.3 kg

Product Details

Country of Origin	China
Product Material	Aluminium
Colour/Finish	Matt Black
Style	Contemporary
Fixings Included	Yes
Easy Clean	Yes
Adjustment Max	893
Adjustment Min	875
Ce Certified	Yes
Declaration Of Performance	Yes
Easy Fit	No
Enclosure Design	Framed
Frame Finish	Matt Black
Glass Thickness	8 mm
Handles Included	No
Support Bar Included	Yes
Ukca Certified	Yes

Sales Code: NTP024

Barcode: 5055369006328

Brand: nuie

Description: nuie 1200 x 900mm Rectangular Shower Tray

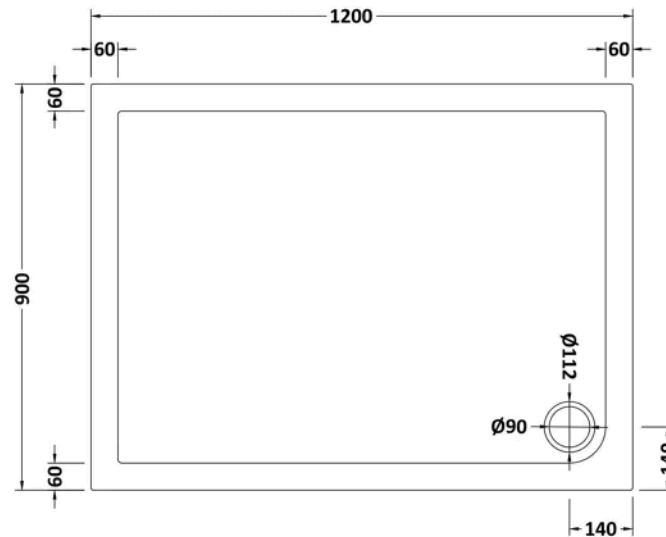

Product Dimensions

Product	40 x 900 x 1200mm (H x W x L)
Packaged	80 x 940 x 1240mm (H x W x D)
Nett Weight	31.7 kg
Packaged Weight	32 kg

Product Details

Country of Origin	United Kingdom
Product Material	Acrylic Capped Abs Caco3 And Pu
Colour/Finish	White
Style	Contemporary
Fixings Included	No
Ce Certified	Yes
Leg Set Included	No
Legs Included	No
Raised Edge	Yes
Slip Resistant	No
Waste Included	No
Waste Size Required	90mm

Sales Code: ENZW016

Barcode: 5056678428726

Brand: nuie

Description: nuie 900mm Framed Walk-In Wetroom Screen Set With Tray

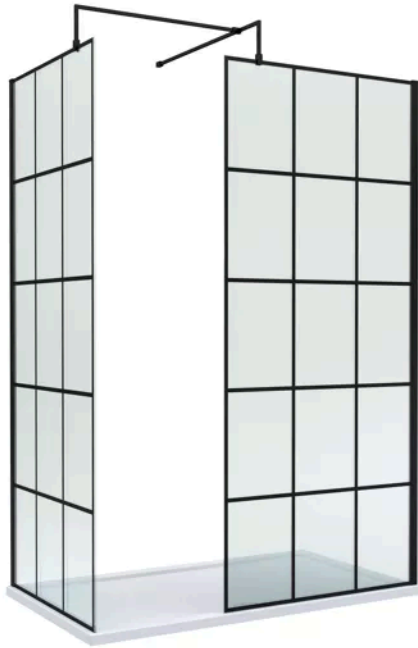

Technical Drawing Not Available

Product Dimensions

Product	1950 x 900 x 14mm (H x W x D)
Nett Weight	97.4 kg
Packaged Weight	97.4 kg

Product Details

Country of Origin	China
Product Material	Acrylic Capped Abs Caco3 And Pu,Aluminium,Glass
Colour/Finish	Matt Black
Style	Contemporary
Ce Certified	Yes
Enclosure Design	Framed
Glass Thickness	8 mm
Waste Included	No

Sales Code: WRSF070

Barcode: 5056211806882

Brand: Hudson Reed

Description: Hudson Reed 700mm Framed Matrix Matt Black Wetroom Screen

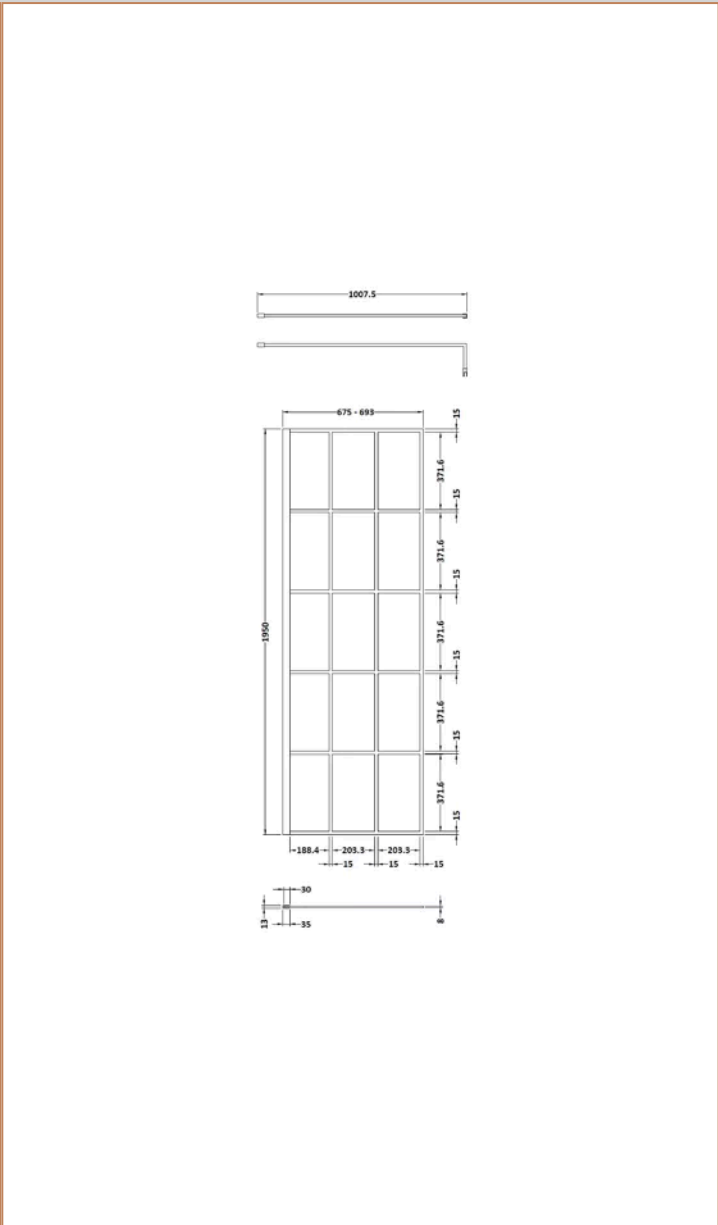
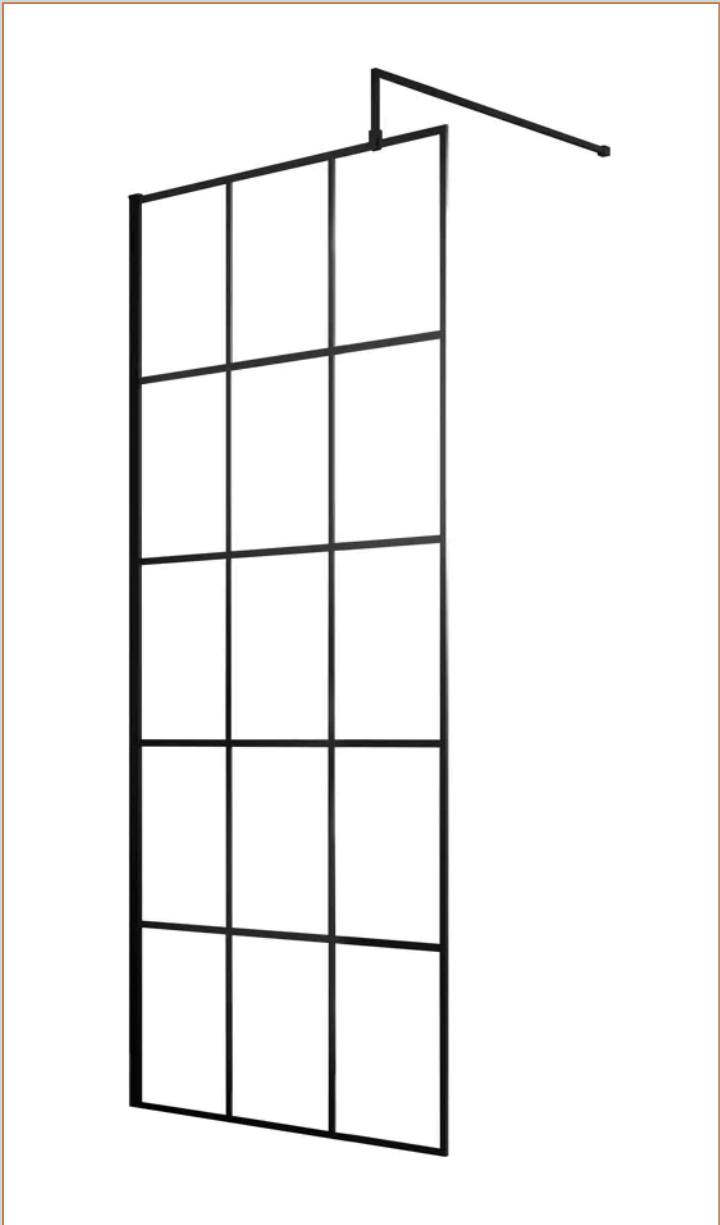

Product Dimensions

Product	1950 x 700 x 14mm (H x W x D)
Packaged	60 x 750 x 2070mm (H x W x D)
Nett Weight	31.1 kg
Packaged Weight	31.1 kg

Product Details

Country of Origin	China
Product Material	Aluminium
Colour/Finish	Matt Black
Style	Contemporary
Fixings Included	Yes
Easy Clean	Yes
Adjustment Max	693
Adjustment Min	675
Ce Certified	Yes
Declaration Of Performance	Yes
Easy Fit	No
Enclosure Design	Framed
Frame Finish	Matt Black
Glass Thickness	8 mm
Handles Included	No
Support Bar Included	Yes
Ukca Certified	Yes

Sales Code: WRSF090

Barcode: 5056211806912

Brand: Hudson Reed

Description: Hudson Reed 900mm Matt Black Matrix Framed Wetroom Screen

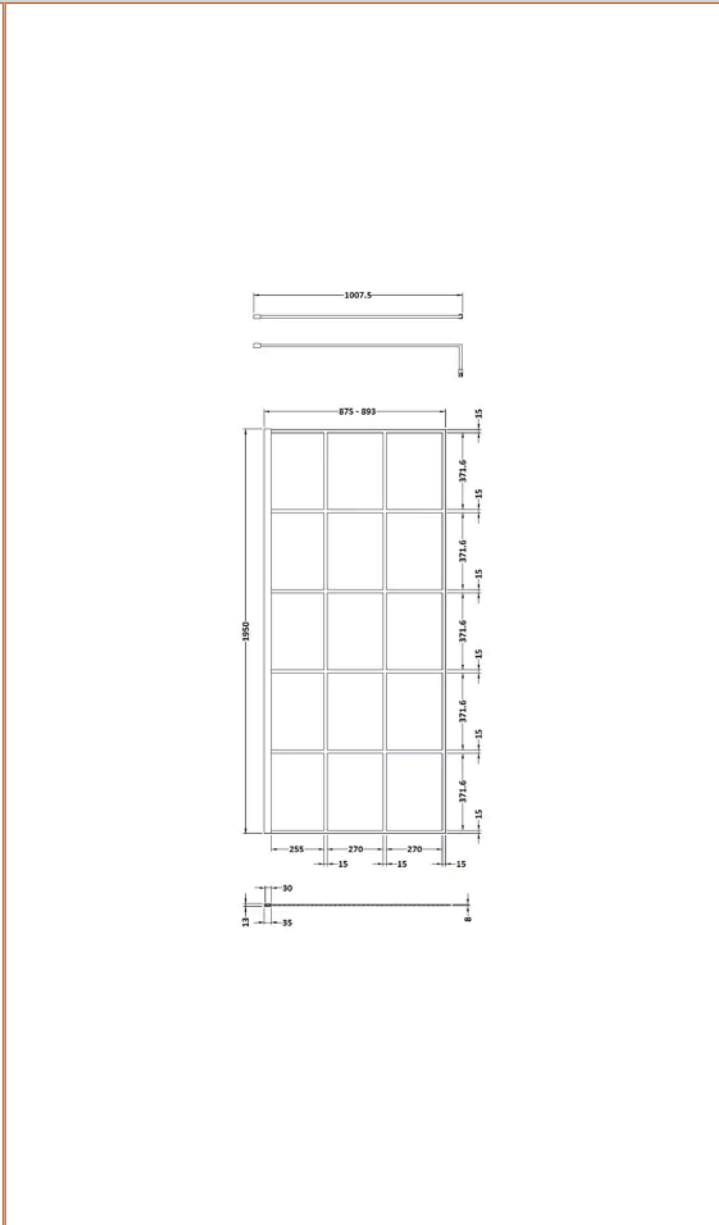
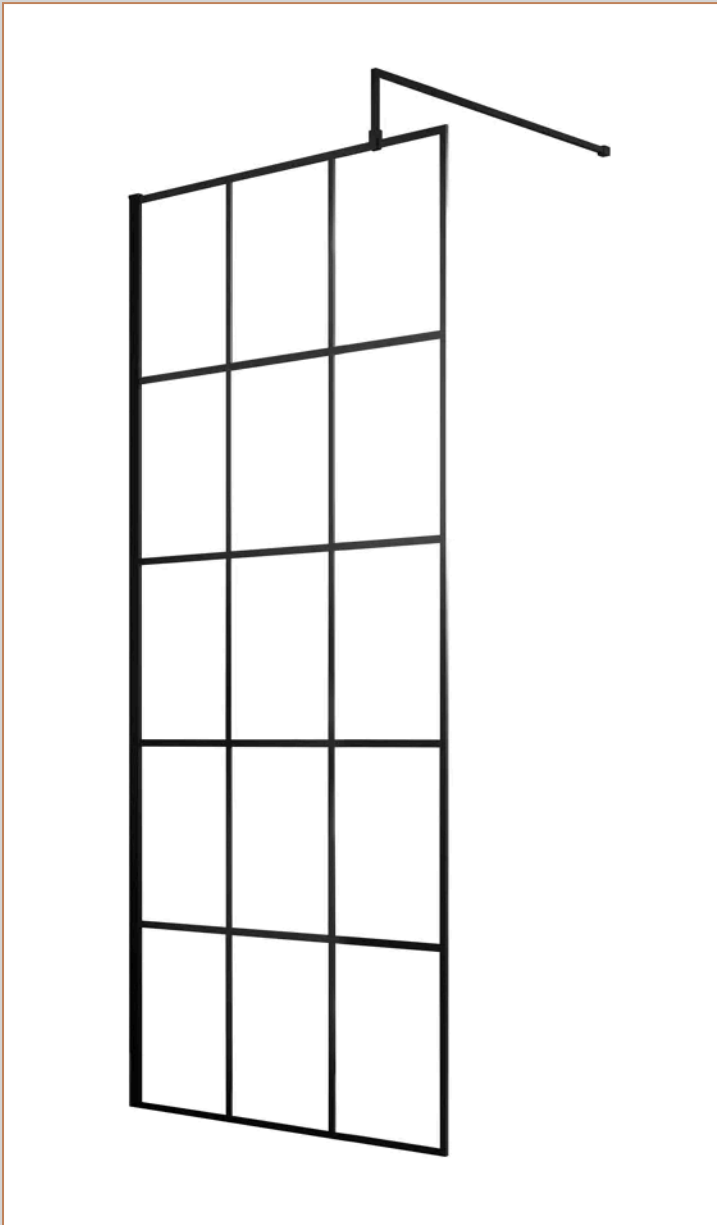

Product Dimensions

Product	1950 x 900 x 14mm (H x W x D)
Packaged	60 x 950 x 2070mm (H x W x D)
Nett Weight	40.3 kg
Packaged Weight	40.3 kg

Product Details

Country of Origin	China
Product Material	Aluminium
Colour/Finish	Matt Black
Style	Contemporary
Fixings Included	Yes
Easy Clean	Yes
Adjustment Max	893
Adjustment Min	875
Ce Certified	Yes
Declaration Of Performance	Yes
Easy Fit	No
Enclosure Design	Framed
Frame Finish	Matt Black
Glass Thickness	8 mm
Handles Included	No
Support Bar Included	Yes
Ukca Certified	Yes

Sales Code: NTP031

Barcode: 5055369071180

Brand: nuie

Description: 1400 x 700mm Rectangular Shower Tray

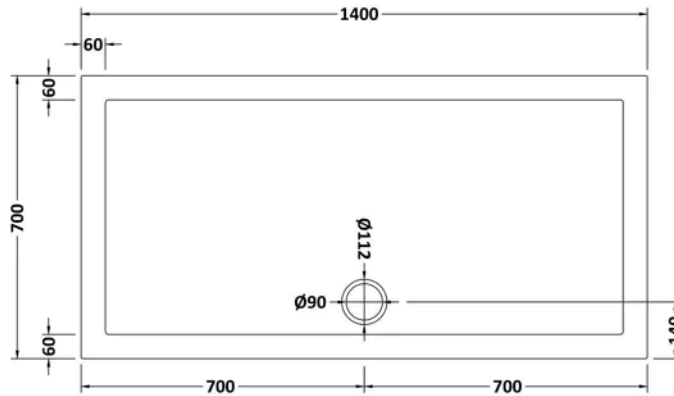

Product Dimensions

Product	40 x 700 x 1400mm (H x W x L)
Packaged	80 x 740 x 1440mm (H x W x D)
Nett Weight	30.8 kg
Packaged Weight	31.1 kg

Product Details

Country of Origin	United Kingdom
Product Material	Acrylic Capped Abs Caco3 And Pu
Colour/Finish	White
Style	Contemporary
Fixings Included	No
Ce Certified	Yes
Leg Set Included	No
Legs Included	No
Raised Edge	Yes
Slip Resistant	No
Waste Included	No
Waste Size Required	90mm

Sales Code: ENZW020

Barcode: 5056678428689

Brand: nuie

Description: nuie 900mm Framed Walk-In Wetroom Screen Set With Tray

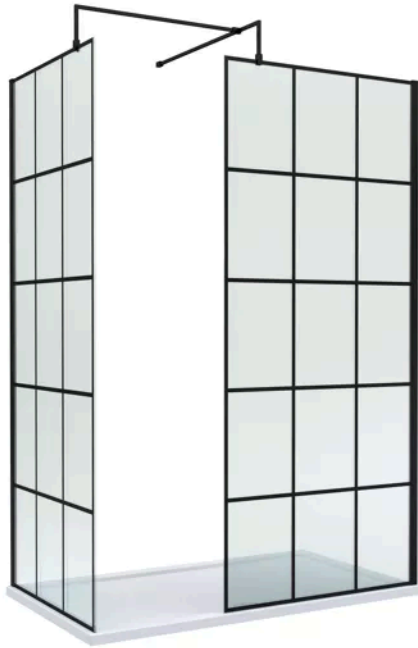

Technical Drawing Not Available

Product Dimensions

Product	1950 x 900 x 14mm (H x W x D)
Nett Weight	110.2 kg
Packaged Weight	110.2 kg

Product Details

Country of Origin	China
Product Material	Acrylic Capped Abs Caco3 And Pu,Aluminium,Glass
Colour/Finish	Matt Black
Style	Contemporary
Ce Certified	Yes
Enclosure Design	Framed
Glass Thickness	8 mm
Waste Included	No

Sales Code: WRSF080

Barcode: 5056211806905

Brand: Hudson Reed

Description: Hudson Reed 800mm Framed Matrix Matt Black Wetroom Screen

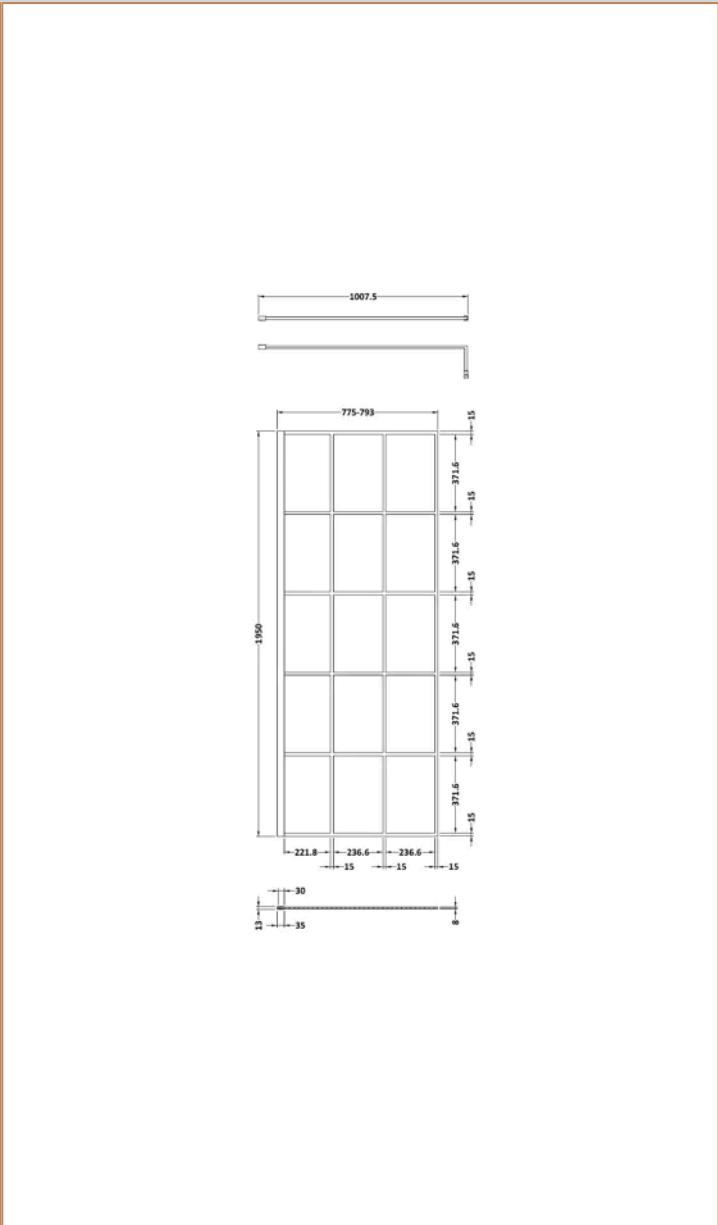
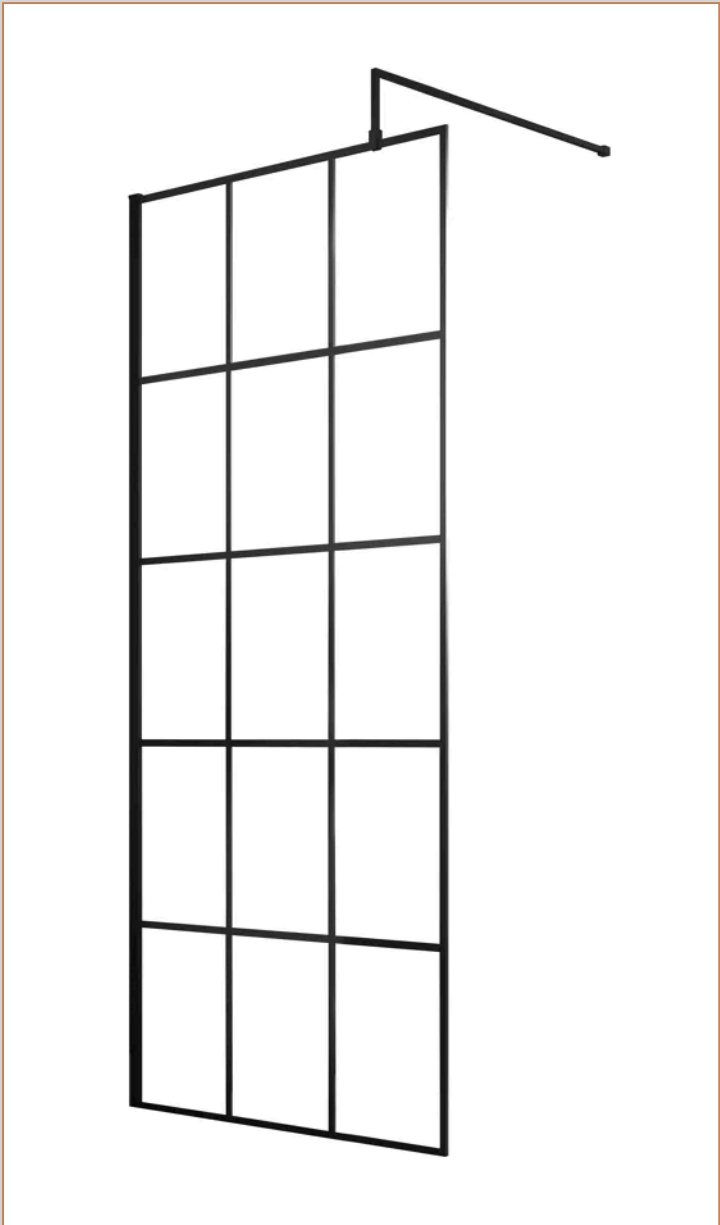

Product Dimensions

Product	1950 x 800 x 14mm (H x W x D)
Packaged	60 x 850 x 2070mm (H x W x D)
Nett Weight	35.9 kg
Packaged Weight	35.9 kg

Product Details

Country of Origin	China
Product Material	Aluminium
Colour/Finish	Matt Black
Style	Contemporary
Fixings Included	Yes
Easy Clean	Yes
Adjustment Max	793
Adjustment Min	775
Ce Certified	Yes
Declaration Of Performance	Yes
Easy Fit	No
Enclosure Design	Framed
Frame Finish	Matt Black
Glass Thickness	8 mm
Handles Included	No
Support Bar Included	Yes
Ukca Certified	Yes

Sales Code: WRSF090

Barcode: 5056211806912

Brand: Hudson Reed

Description: Hudson Reed 900mm Matt Black Matrix Framed Wetroom Screen

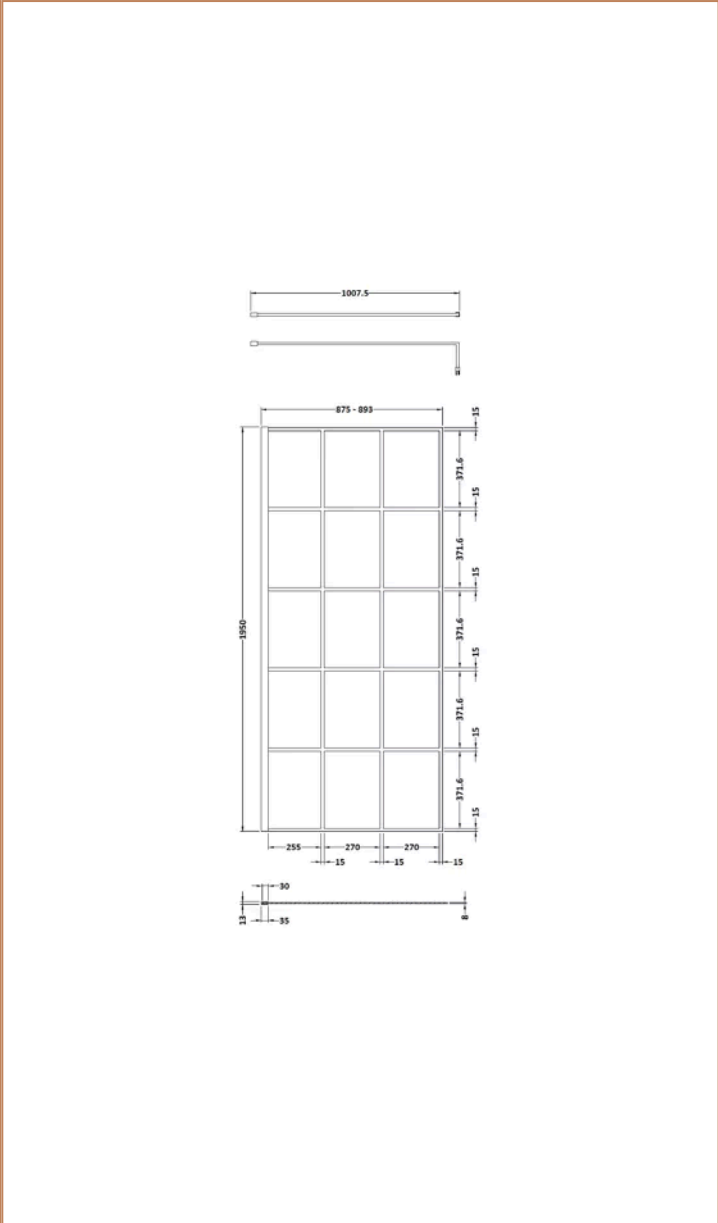
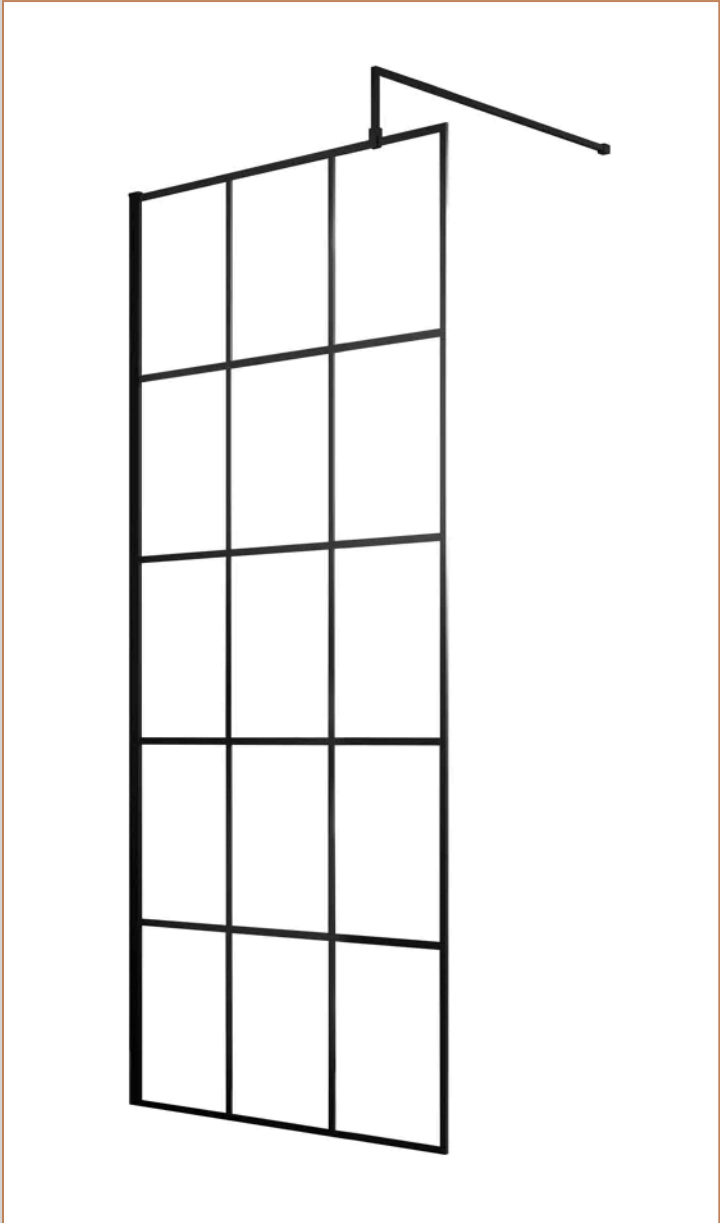

Product Dimensions

Product	1950 x 900 x 14mm (H x W x D)
Packaged	60 x 950 x 2070mm (H x W x D)
Nett Weight	40.3 kg
Packaged Weight	40.3 kg

Product Details

Country of Origin	China
Product Material	Aluminium
Colour/Finish	Matt Black
Style	Contemporary
Fixings Included	Yes
Easy Clean	Yes
Adjustment Max	893
Adjustment Min	875
Ce Certified	Yes
Declaration Of Performance	Yes
Easy Fit	No
Enclosure Design	Framed
Frame Finish	Matt Black
Glass Thickness	8 mm
Handles Included	No
Support Bar Included	Yes
Ukca Certified	Yes

Sales Code: NTP033

Barcode: 5055369006335

Brand: nuie

Description: 1400 x 800mm Rectangular Slimline Shower Tray

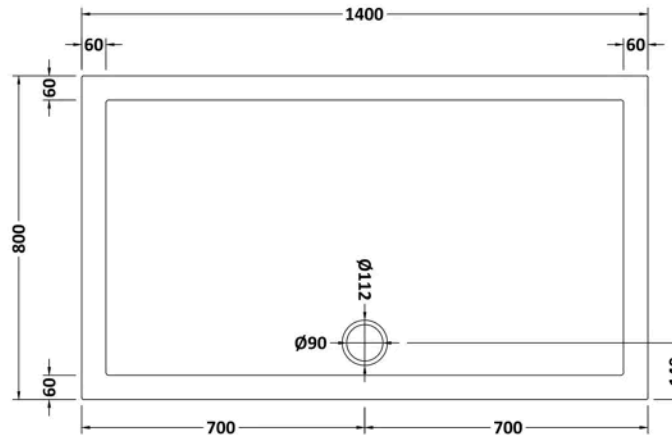

Product Dimensions

Product	40 x 800 x 1400mm (H x W x L)
Packaged	80 x 840 x 1440mm (H x W x D)
Nett Weight	36.6 kg
Packaged Weight	36.9 kg

Product Details

Country of Origin	United Kingdom
Product Material	Acrylic Capped Abs Caco3 And Pu
Colour/Finish	White
Style	Contemporary
Fixings Included	No
Ce Certified	Yes
Leg Set Included	No
Legs Included	No
Raised Edge	Yes
Slip Resistant	No
Waste Included	No
Waste Size Required	90mm

Sales Code: ENZW027

Barcode: 5056678428610

Brand: nuie

Description: nuie 900mm Walk-In Matt Black Wetroom Screen Set With Tray

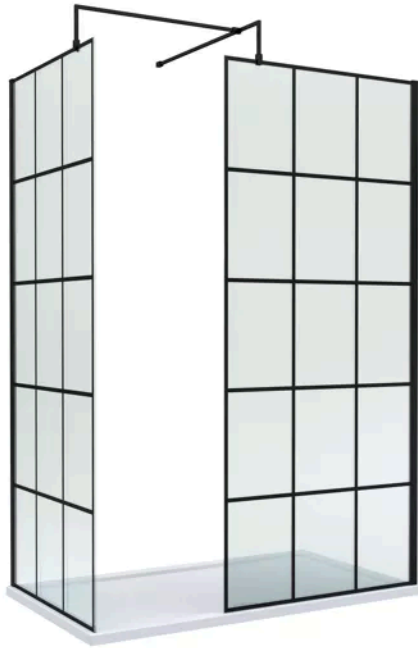

Technical Drawing Not Available

Product Dimensions

Product	1950 x 900 x 14mm (H x W x D)
Nett Weight	112 kg
Packaged Weight	112 kg

Product Details

Country of Origin	China
Product Material	Acrylic Capped Abs Caco3 And Pu,Aluminium,Glass
Colour/Finish	Matt Black
Style	Contemporary
Ce Certified	Yes
Glass Thickness	8 mm
Waste Included	No

Sales Code: WRSF090

Barcode: 5056211806912

Brand: Hudson Reed

Description: Hudson Reed 900mm Matt Black Matrix Framed Wetroom Screen

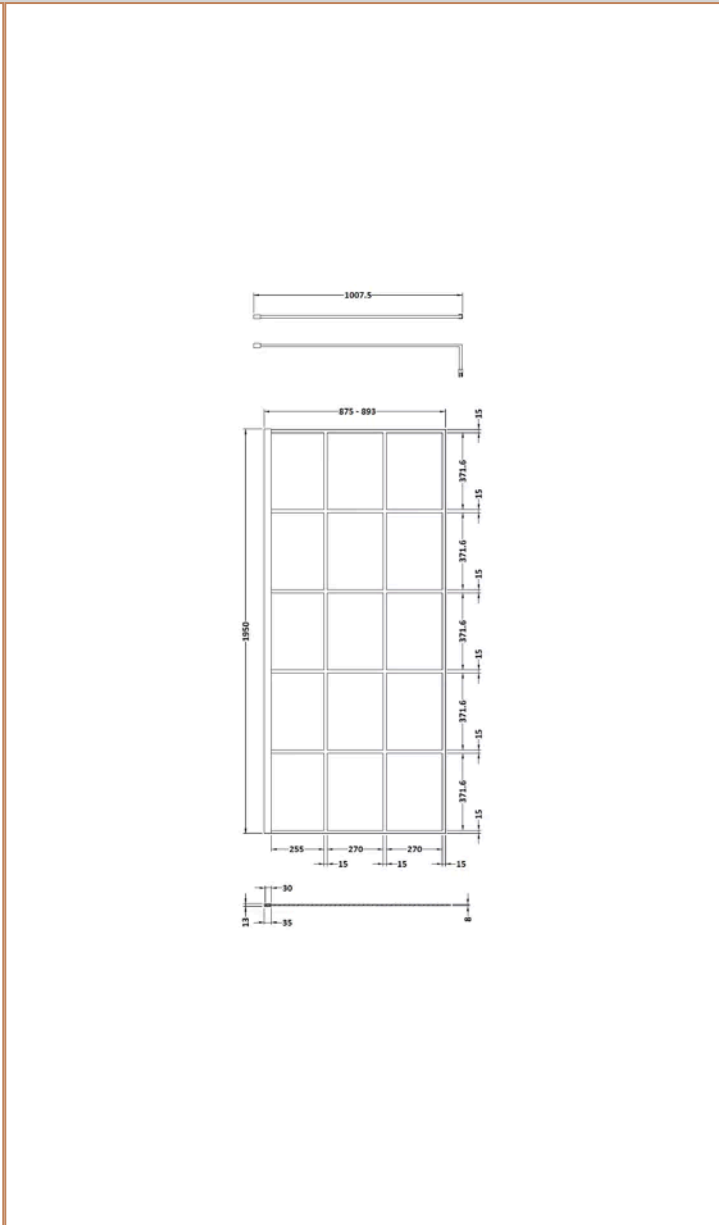
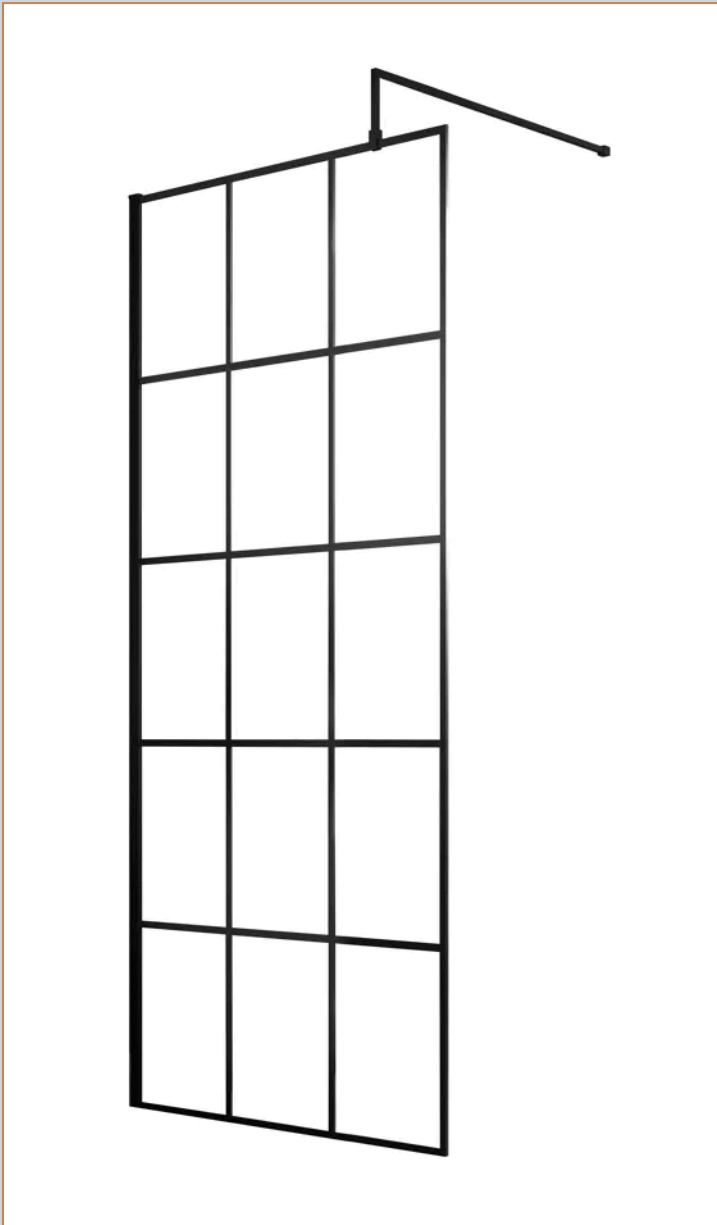

Product Dimensions

Product	1950 x 900 x 14mm (H x W x D)
Packaged	60 x 950 x 2070mm (H x W x D)
Nett Weight	40.3 kg
Packaged Weight	40.3 kg

Product Details

Country of Origin	China
Product Material	Aluminium
Colour/Finish	Matt Black
Style	Contemporary
Fixings Included	Yes
Easy Clean	Yes
Adjustment Max	893
Adjustment Min	875
Ce Certified	Yes
Declaration Of Performance	Yes
Easy Fit	No
Enclosure Design	Framed
Frame Finish	Matt Black
Glass Thickness	8 mm
Handles Included	No
Support Bar Included	Yes
Ukca Certified	Yes

Sales Code: NTP034

Barcode: 5055369006342

Brand: nuie

Description: 1400 x 900mm Rectangular Slimline Shower Tray

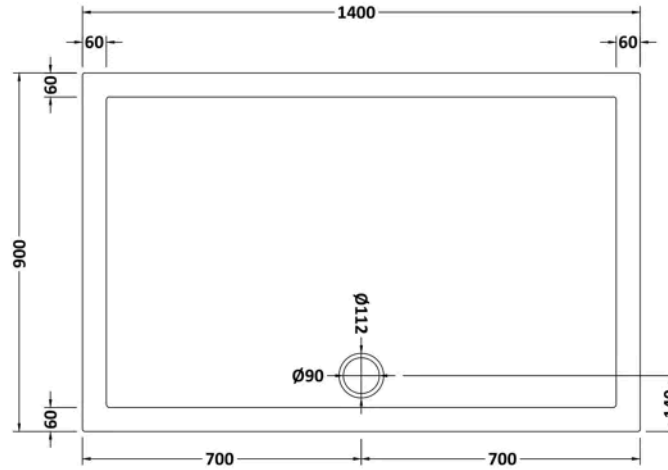

Product Dimensions

Product	40 x 900 x 1400mm (H x W x L)
Packaged	80 x 940 x 1440mm (H x W x D)
Nett Weight	36.8 kg
Packaged Weight	37.1 kg

Product Details

Country of Origin	United Kingdom
Product Material	Acrylic Capped Abs Caco3 And Pu
Colour/Finish	White
Style	Contemporary
Fixings Included	No
Ce Certified	Yes
Leg Set Included	No
Legs Included	No
Raised Edge	Yes
Slip Resistant	No
Waste Included	No
Waste Size Required	90mm

Sales Code: ENZW034

Barcode: 5056678428542

Brand: nuie

Description: nuie 1200mm Framed Walk-In Wetroom Screen Set With Tray



Technical Drawing Not Available

Product Dimensions

Product	1950 x 1200 x 14mm (H x W x D)
Nett Weight	116.5 kg
Packaged Weight	116.5 kg

Product Details

Country of Origin	China
Product Material	Acrylic Capped Abs Caco3 And Pu,Aluminium,Glass
Colour/Finish	Matt Black
Style	Contemporary
Ce Certified	Yes
Enclosure Design	Framed
Glass Thickness	8 mm
Waste Included	No

Sales Code: WRSF070

Barcode: 5056211806882

Brand: Hudson Reed

Description: Hudson Reed 700mm Framed Matrix Matt Black Wetroom Screen

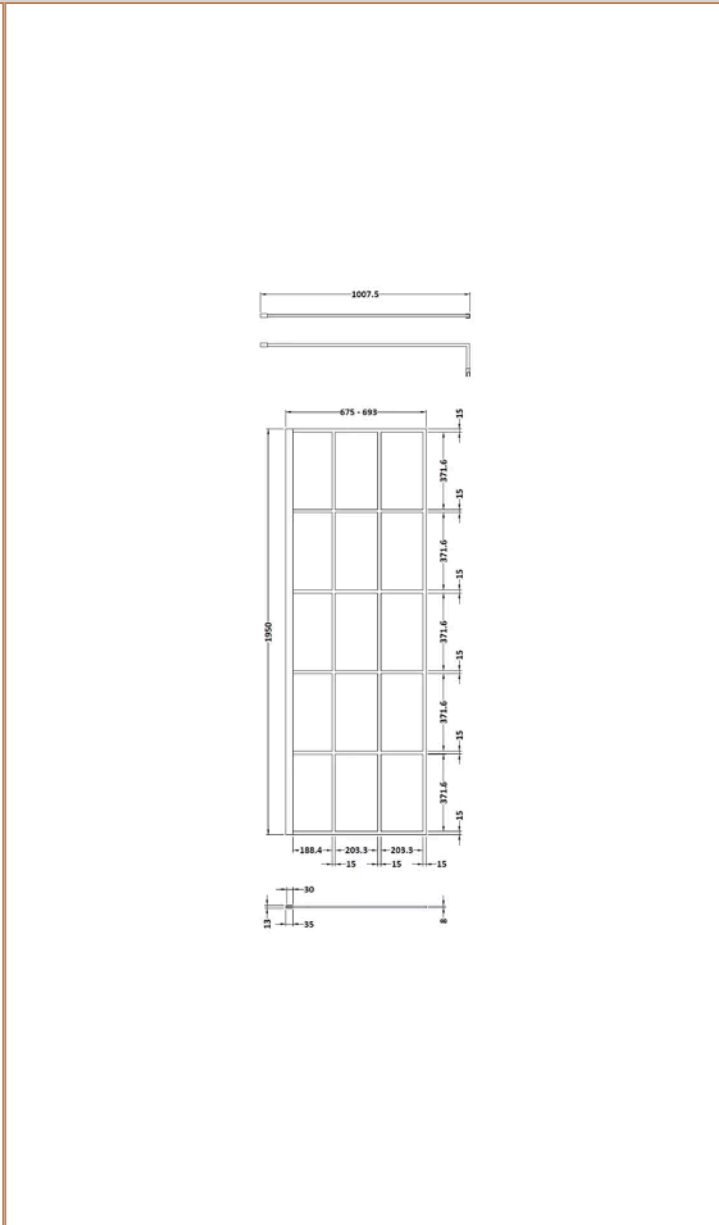
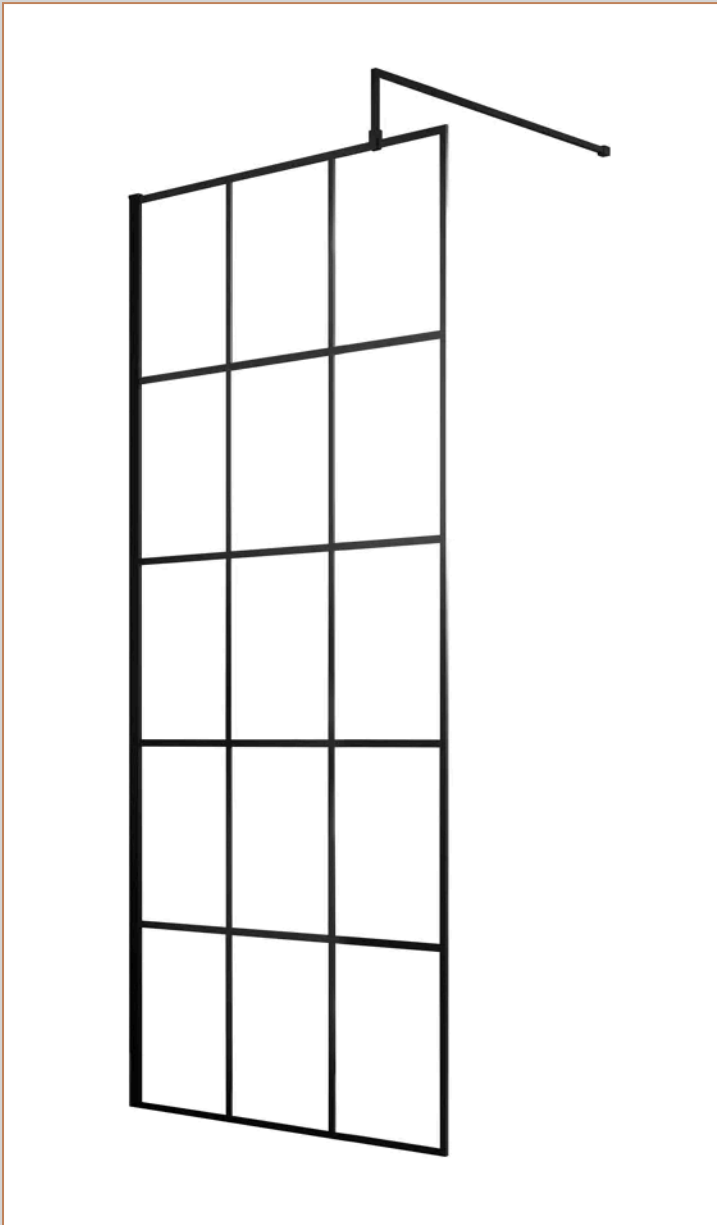

Product Dimensions

Product	1950 x 700 x 14mm (H x W x D)
Packaged	60 x 750 x 2070mm (H x W x D)
Nett Weight	31.1 kg
Packaged Weight	31.1 kg

Product Details

Country of Origin	China
Product Material	Aluminium
Colour/Finish	Matt Black
Style	Contemporary
Fixings Included	Yes
Easy Clean	Yes
Adjustment Max	693
Adjustment Min	675
Ce Certified	Yes
Declaration Of Performance	Yes
Easy Fit	No
Enclosure Design	Framed
Frame Finish	Matt Black
Glass Thickness	8 mm
Handles Included	No
Support Bar Included	Yes
Ukca Certified	Yes

Sales Code: WRSF12

Barcode: 5056211806943

Brand: Hudson Reed

Description: Hudson Reed 1200mm Matt Black Matrix Framed Wetroom Screen

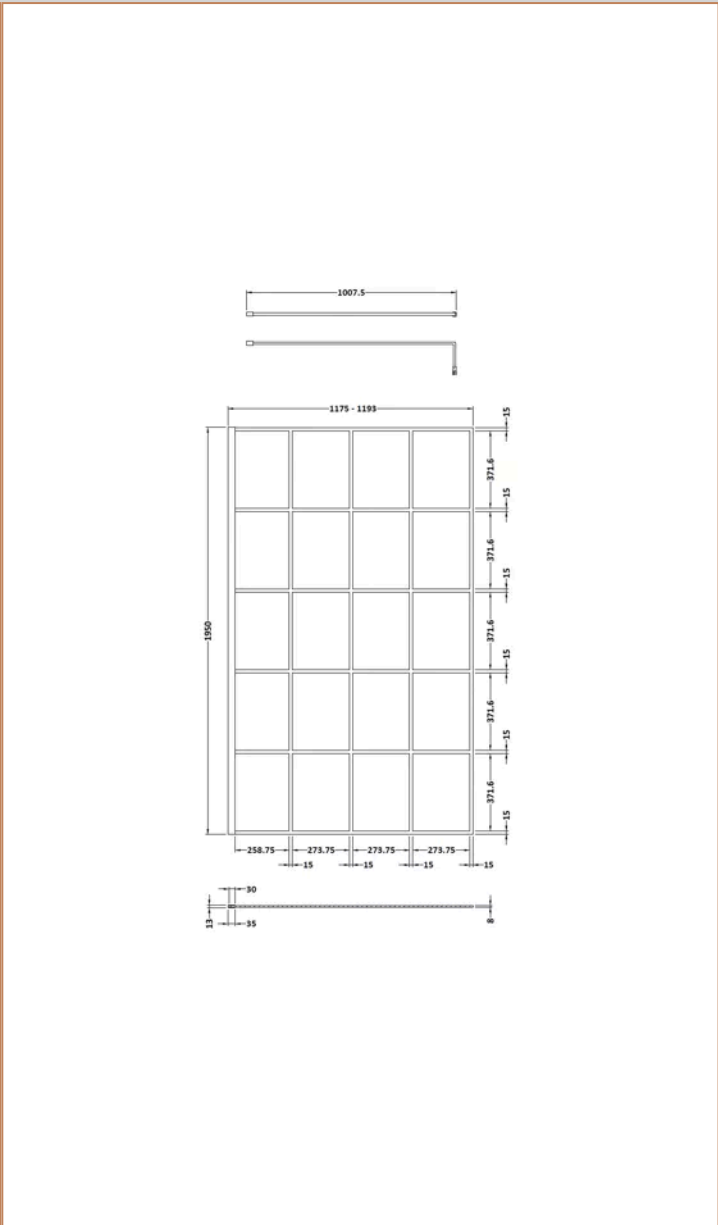
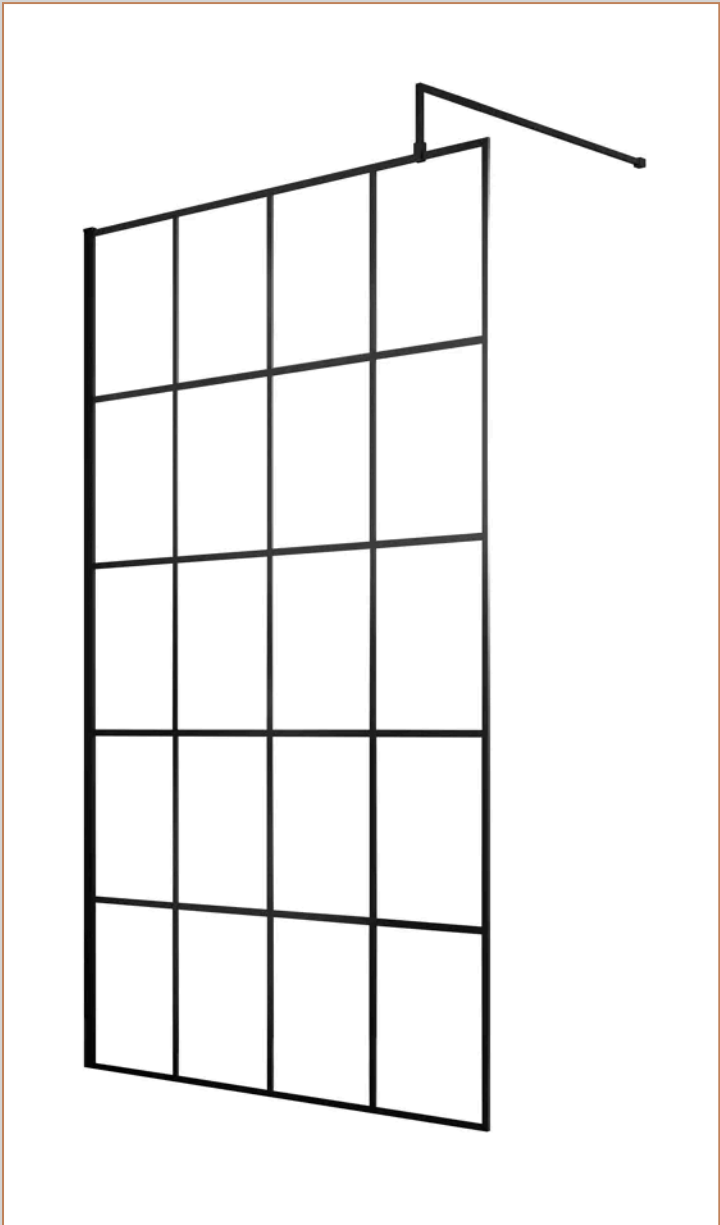

Product Dimensions

Product	1950 x 1200 x 14mm (H x W x D)
Packaged	60 x 1250 x 2070mm (H x W x D)
Nett Weight	53.2 kg
Packaged Weight	53.2 kg

Product Details

Country of Origin	China
Product Material	Aluminium
Colour/Finish	Matt Black
Style	Contemporary
Fixings Included	Yes
Easy Clean	Yes
Adjustment Max	1193
Adjustment Min	1175
Ce Certified	Yes
Declaration Of Performance	Yes
Easy Fit	No
Enclosure Design	Framed
Frame Finish	Matt Black
Glass Thickness	8 mm
Handles Included	No
Support Bar Included	Yes
Ukca Certified	Yes

Sales Code: NTP061

Barcode: 5055369006373

Brand: nuie

Description: 1700 x 700mm Rectangular Slimline Shower Tray

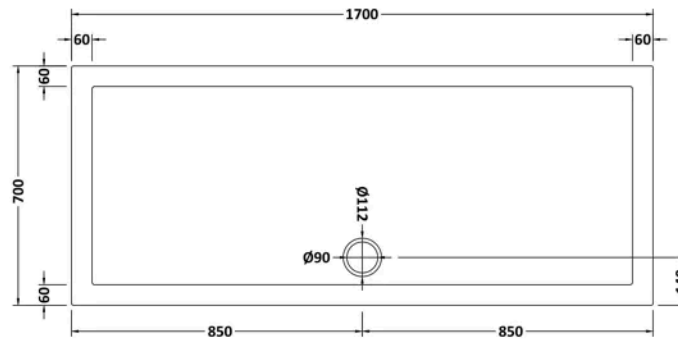

Product Dimensions

Product	40 x 700 x 1700mm (H x W x L)
Packaged	80 x 740 x 1740mm (H x W x D)
Nett Weight	37.8 kg
Packaged Weight	38.1 kg

Product Details

Country of Origin	United Kingdom
Product Material	Acrylic Capped Abs Caco3 And Pu
Colour/Finish	White
Style	Contemporary
Fixings Included	No
Ce Certified	Yes
Leg Set Included	No
Legs Included	No
Raised Edge	Yes
Slip Resistant	No
Waste Included	No
Waste Size Required	90mm

Sales Code: ENZW038

Barcode: 5056678428504

Brand: nuie

Description: nuie 800mm Framed Walk-In Wetroom Screen Set With Tray



Technical Drawing Not Available

Product Dimensions

Product	1950 x 800 x 14mm (H x W x D)
Nett Weight	124.2 kg
Packaged Weight	124.2 kg

Product Details

Country of Origin	China
Product Material	Acrylic Capped Abs Caco3 And Pu,Aluminium,Glass
Colour/Finish	Matt Black
Style	Contemporary
Ce Certified	Yes
Enclosure Design	Framed
Glass Thickness	8 mm
Waste Included	No

Sales Code: WRSF080

Barcode: 5056211806905

Brand: Hudson Reed

Description: Hudson Reed 800mm Framed Matrix Matt Black Wetroom Screen

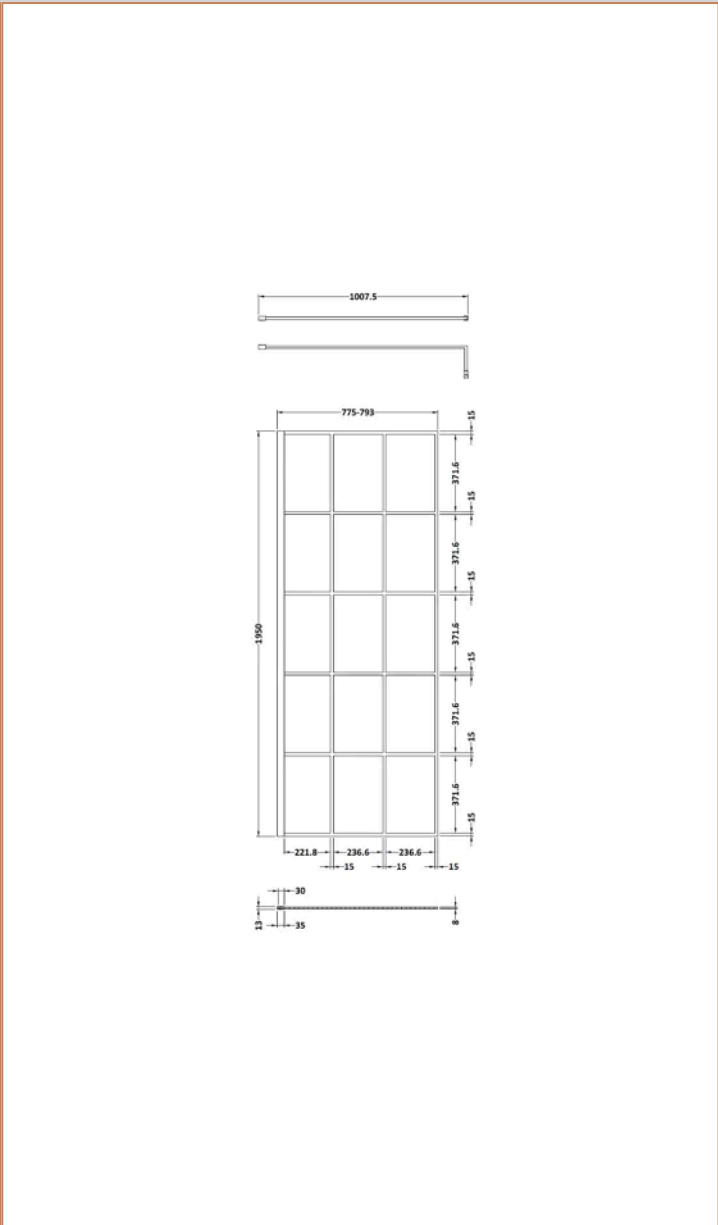
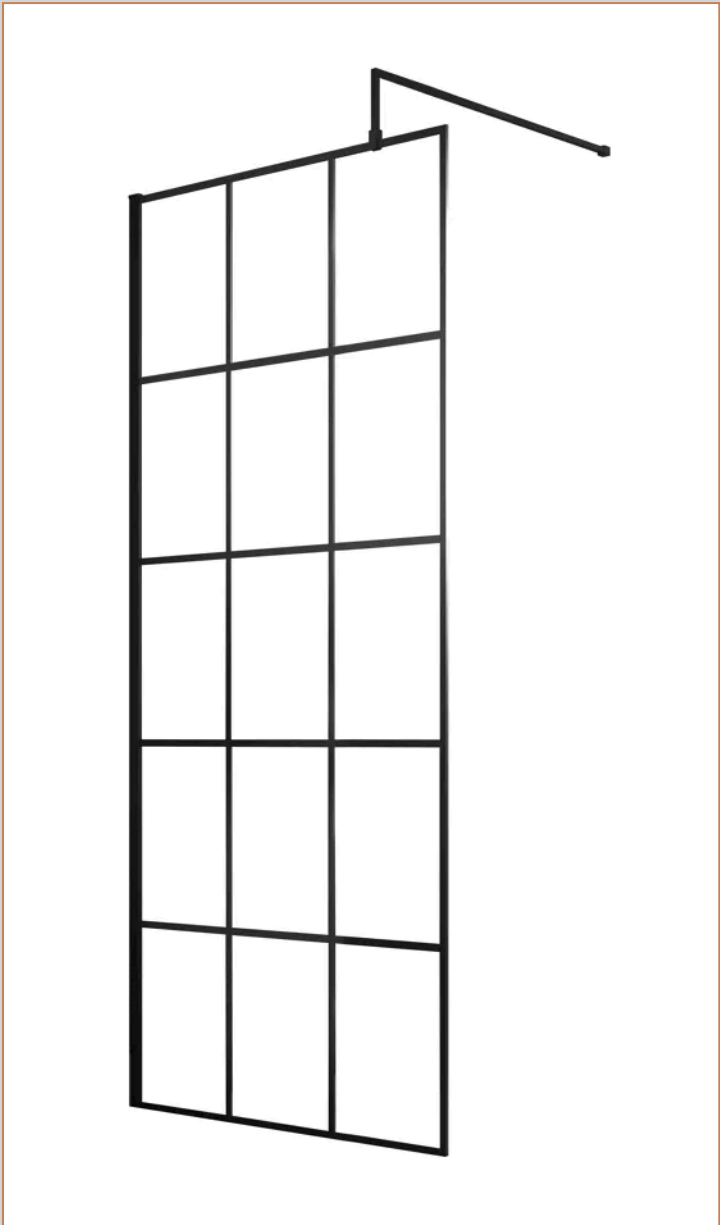

Product Dimensions

Product	1950 x 800 x 14mm (H x W x D)
Packaged	60 x 850 x 2070mm (H x W x D)
Nett Weight	35.9 kg
Packaged Weight	35.9 kg

Product Details

Country of Origin	China
Product Material	Aluminium
Colour/Finish	Matt Black
Style	Contemporary
Fixings Included	Yes
Easy Clean	Yes
Adjustment Max	793
Adjustment Min	775
Ce Certified	Yes
Declaration Of Performance	Yes
Easy Fit	No
Enclosure Design	Framed
Frame Finish	Matt Black
Glass Thickness	8 mm
Handles Included	No
Support Bar Included	Yes
Ukca Certified	Yes

Sales Code: WRSF12

Barcode: 5056211806943

Brand: Hudson Reed

Description: Hudson Reed 1200mm Matt Black Matrix Framed Wetroom Screen

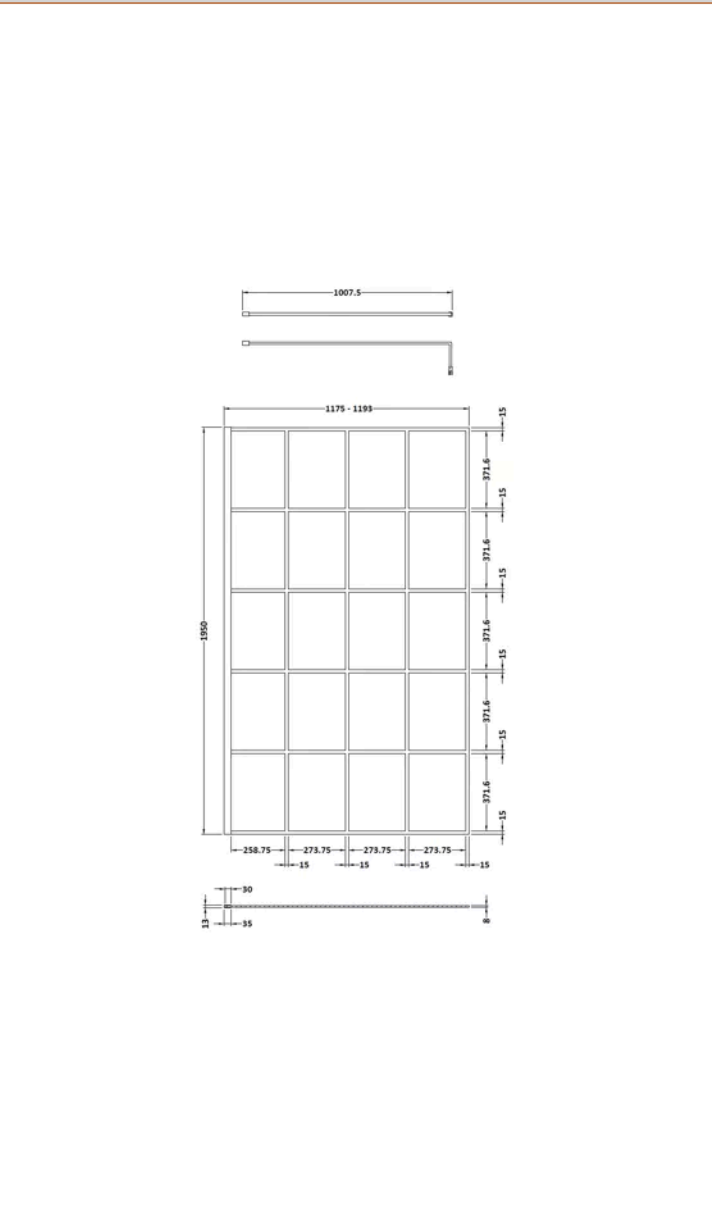
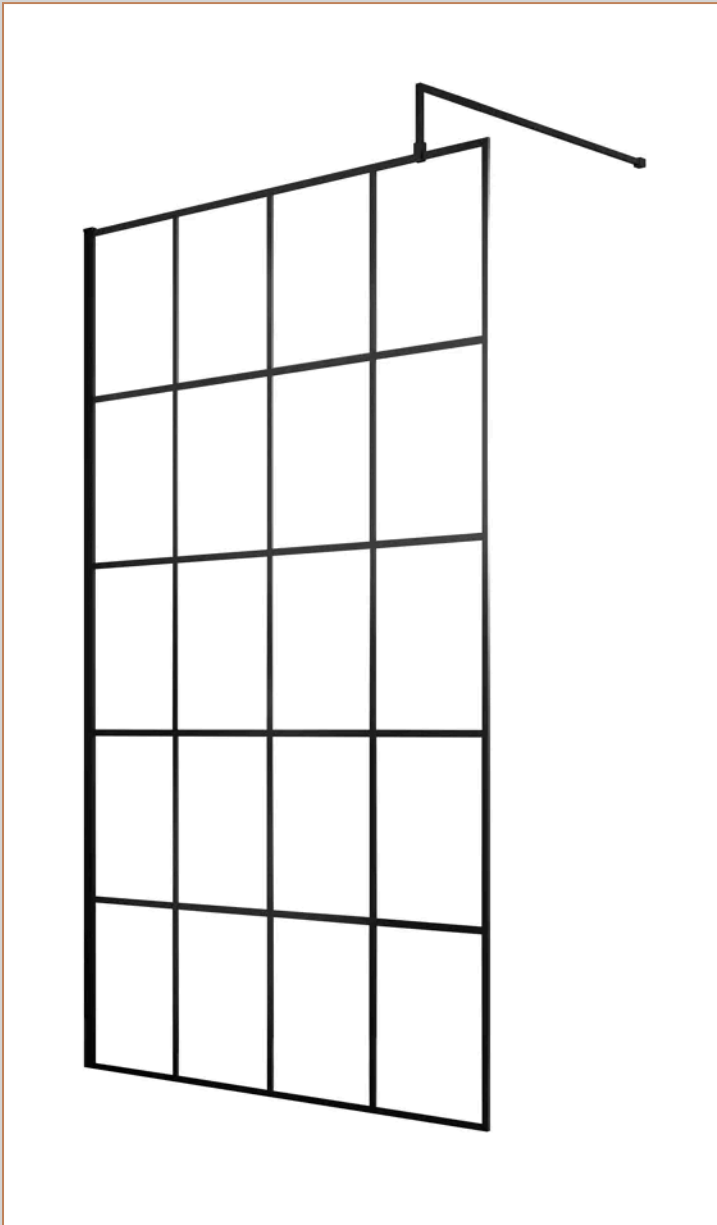

Product Dimensions

Product	1950 x 1200 x 14mm (H x W x D)
Packaged	60 x 1250 x 2070mm (H x W x D)
Nett Weight	53.2 kg
Packaged Weight	53.2 kg

Product Details

Country of Origin	China
Product Material	Aluminium
Colour/Finish	Matt Black
Style	Contemporary
Fixings Included	Yes
Easy Clean	Yes
Adjustment Max	1193
Adjustment Min	1175
Ce Certified	Yes
Declaration Of Performance	Yes
Easy Fit	No
Enclosure Design	Framed
Frame Finish	Matt Black
Glass Thickness	8 mm
Handles Included	No
Support Bar Included	Yes
Ukca Certified	Yes

Sales Code: NTP063

Barcode: 5055369006380

Brand: nuie

Description: 1700 x 800mm Rectangular Slimline Shower Tray

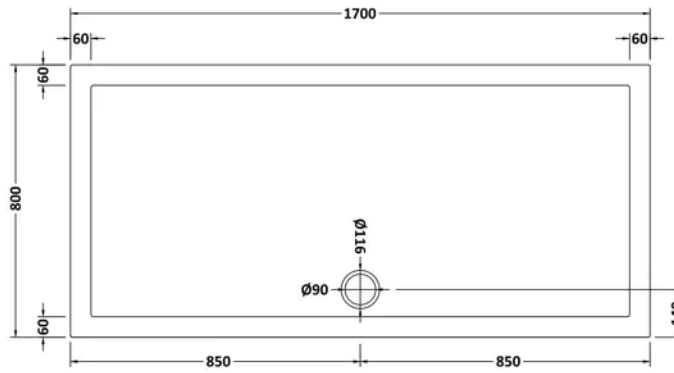

Product Dimensions

Product	40 x 800 x 1700mm (H x W x L)
Packaged	80 x 840 x 1740mm (H x W x D)
Nett Weight	43.2 kg
Packaged Weight	43.5 kg

Product Details

Country of Origin	United Kingdom
Product Material	Acrylic Capped Abs Caco3 And Pu
Colour/Finish	White
Style	Contemporary
Fixings Included	No
Ce Certified	Yes
Leg Set Included	No
Legs Included	No
Raised Edge	Yes
Slip Resistant	No
Waste Included	No
Waste Size Required	90mm

Sales Code: ENZW042

Barcode: 5056678428467

Brand: nuie

Description: nuie 900mm Framed Walk-In Wetroom Screen Set With Tray



Technical Drawing Not Available

Product Dimensions

Product	1950 x 900 x 14mm (H x W x D)
Nett Weight	135.1 kg
Packaged Weight	135.1 kg

Product Details

Country of Origin	China
Product Material	Acrylic Capped Abs Caco3 And Pu,Aluminium,Glass
Colour/Finish	Matt Black
Style	Contemporary
Ce Certified	Yes
Enclosure Design	Framed
Glass Thickness	8 mm
Waste Included	No

Sales Code: WRSF090

Barcode: 5056211806912

Brand: Hudson Reed

Description: Hudson Reed 900mm Matt Black Matrix Framed Wetroom Screen

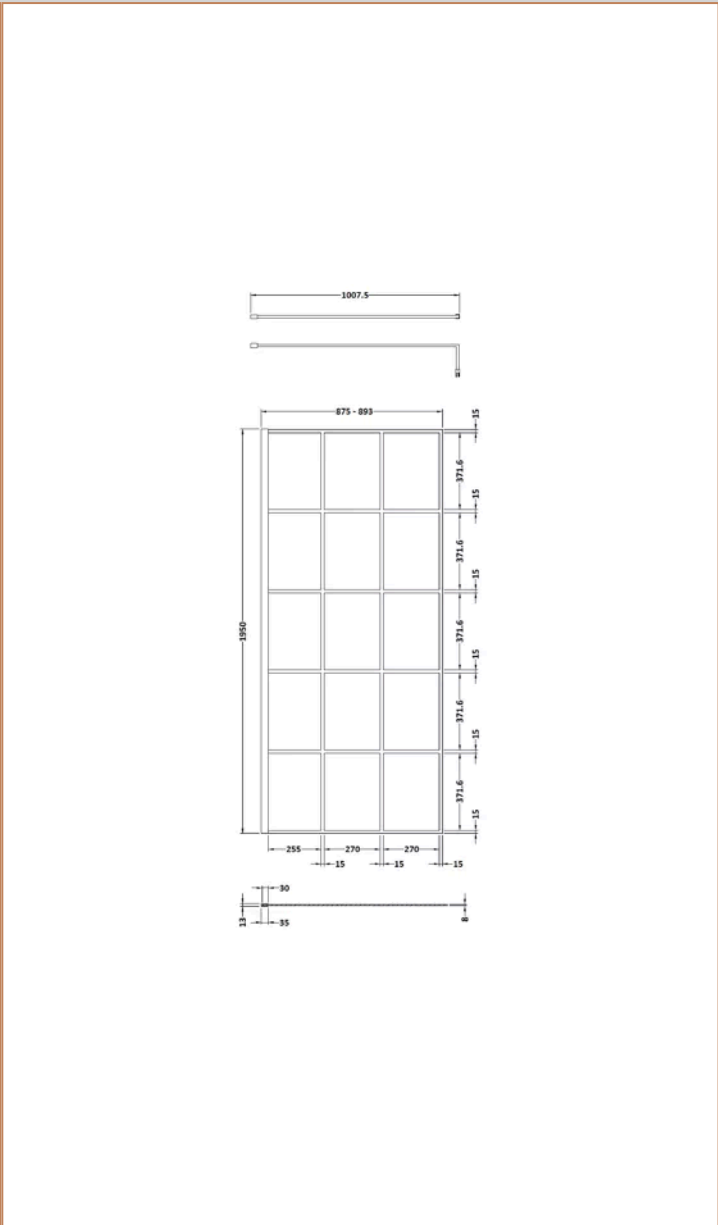
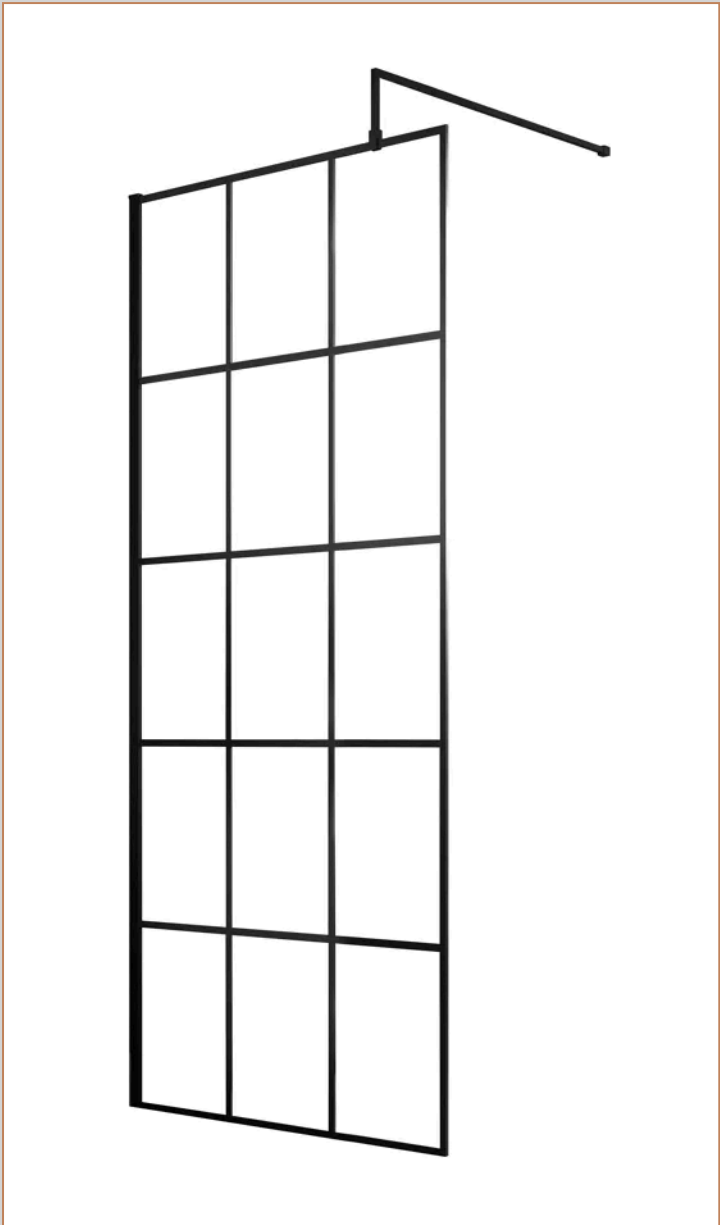

Product Dimensions

Product	1950 x 900 x 14mm (H x W x D)
Packaged	60 x 950 x 2070mm (H x W x D)
Nett Weight	40.3 kg
Packaged Weight	40.3 kg

Product Details

Country of Origin	China
Product Material	Aluminium
Colour/Finish	Matt Black
Style	Contemporary
Fixings Included	Yes
Easy Clean	Yes
Adjustment Max	893
Adjustment Min	875
Ce Certified	Yes
Declaration Of Performance	Yes
Easy Fit	No
Enclosure Design	Framed
Frame Finish	Matt Black
Glass Thickness	8 mm
Handles Included	No
Support Bar Included	Yes
Ukca Certified	Yes

Sales Code: WRSF12

Barcode: 5056211806943

Brand: Hudson Reed

Description: Hudson Reed 1200mm Matt Black Matrix Framed Wetroom Screen

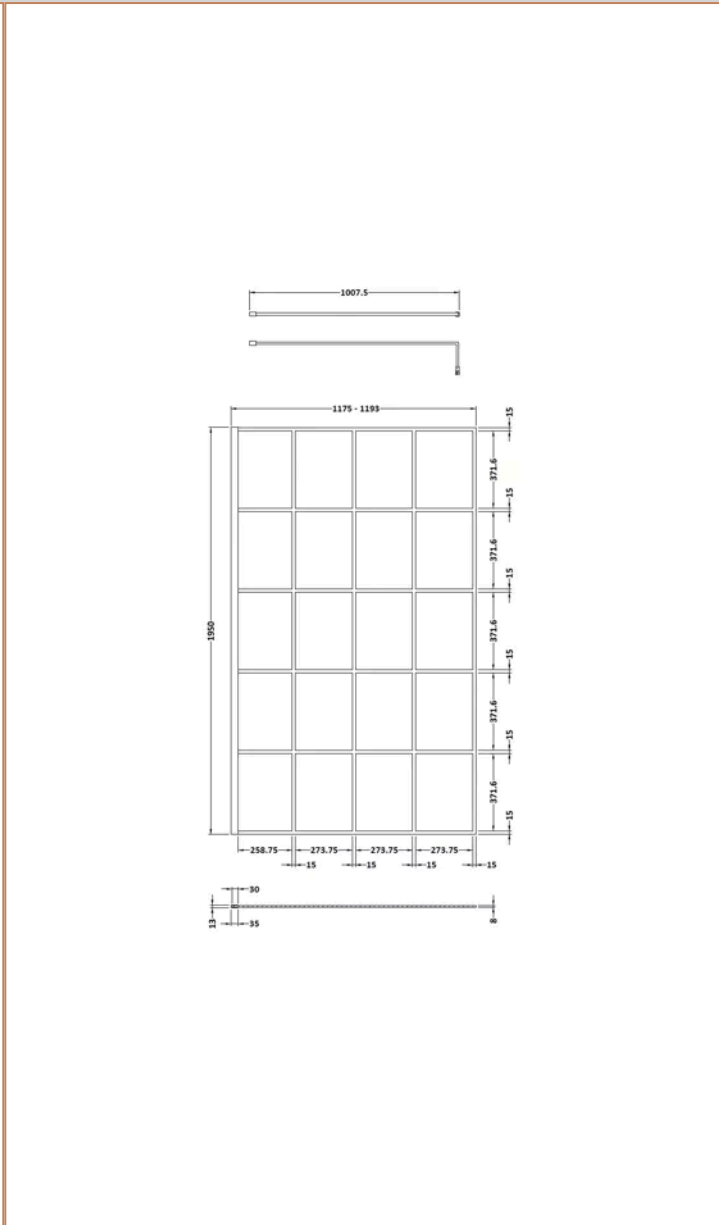
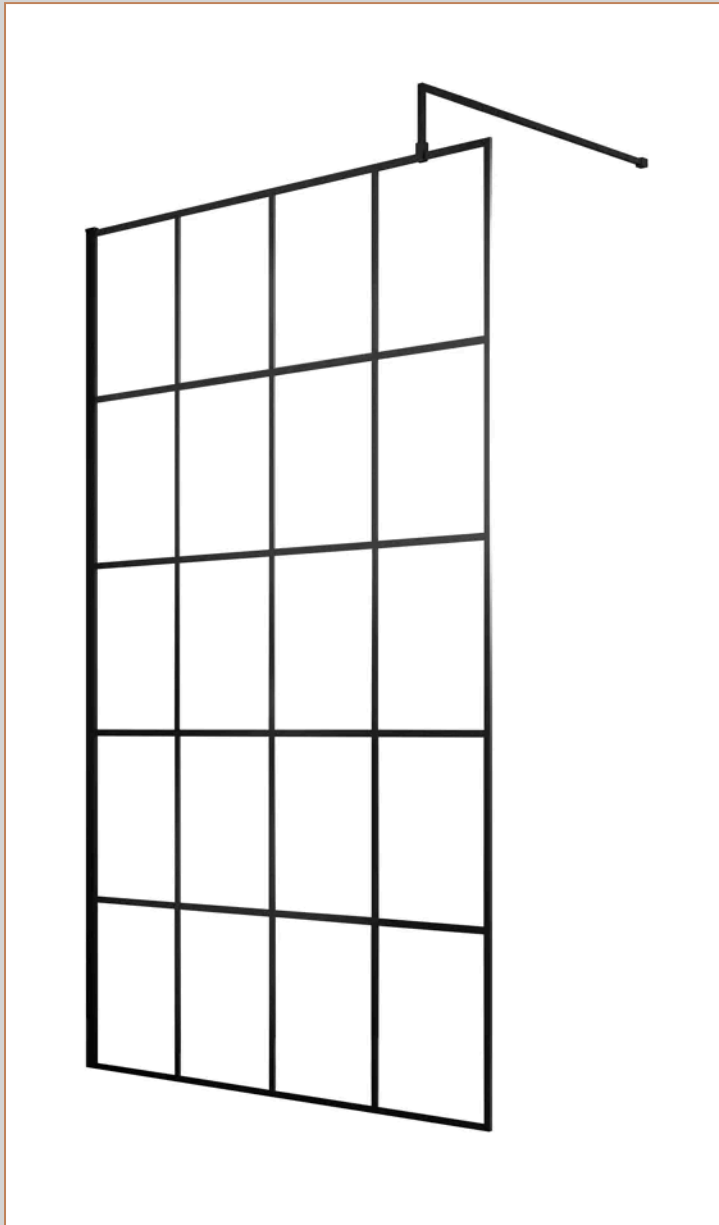

Product Dimensions

Product	1950 x 1200 x 14mm (H x W x D)
Packaged	60 x 1250 x 2070mm (H x W x D)
Nett Weight	53.2 kg
Packaged Weight	53.2 kg

Product Details

Country of Origin	China
Product Material	Aluminium
Colour/Finish	Matt Black
Style	Contemporary
Fixings Included	Yes
Easy Clean	Yes
Adjustment Max	1193
Adjustment Min	1175
Ce Certified	Yes
Declaration Of Performance	Yes
Easy Fit	No
Enclosure Design	Framed
Frame Finish	Matt Black
Glass Thickness	8 mm
Handles Included	No
Support Bar Included	Yes
Ukca Certified	Yes

Sales Code: NTP064

Barcode: 5055275869130

Brand: nuie

Description: 1700 x 900mm Rectangular Shower Tray

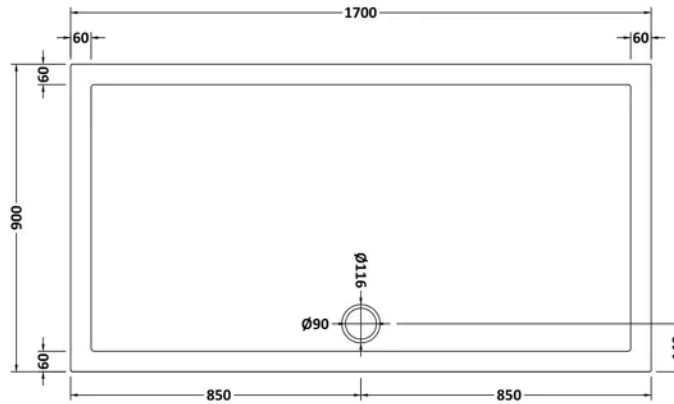

Product Dimensions

Product	40 x 900 x 1700mm (H x W x L)
Packaged	80 x 940 x 1740mm (H x W x D)
Nett Weight	50.5 kg
Packaged Weight	50.8 kg

Product Details

Country of Origin	United Kingdom
Product Material	Acrylic Capped Abs Caco3 And Pu
Colour/Finish	White
Style	Contemporary
Fixings Included	No
Ce Certified	Yes
Leg Set Included	No
Legs Included	No
Raised Edge	Yes
Slip Resistant	No
Waste Included	No
Waste Size Required	90mm

Sales Code: ENZW004

Barcode: 5056678428849

Brand: nuie

Description: nuie 700mm Framed Walk-In Wetroom Screen Set With Tray



Technical Drawing Not Available

Product Dimensions

Product	1950 x 700 x 14mm (H x W x D)
Nett Weight	85 kg
Packaged Weight	85 kg

Product Details

Country of Origin	China
Product Material	Acrylic Capped Abs Caco3 And Pu,Aluminium,Glass
Colour/Finish	Matt Black
Style	Contemporary
Ce Certified	Yes
Enclosure Design	Framed
Glass Thickness	8 mm
Waste Included	No

Sales Code: WRSF070

Barcode: 5056211806882

Brand: Hudson Reed

Description: Hudson Reed 700mm Framed Matrix Matt Black Wetroom Screen

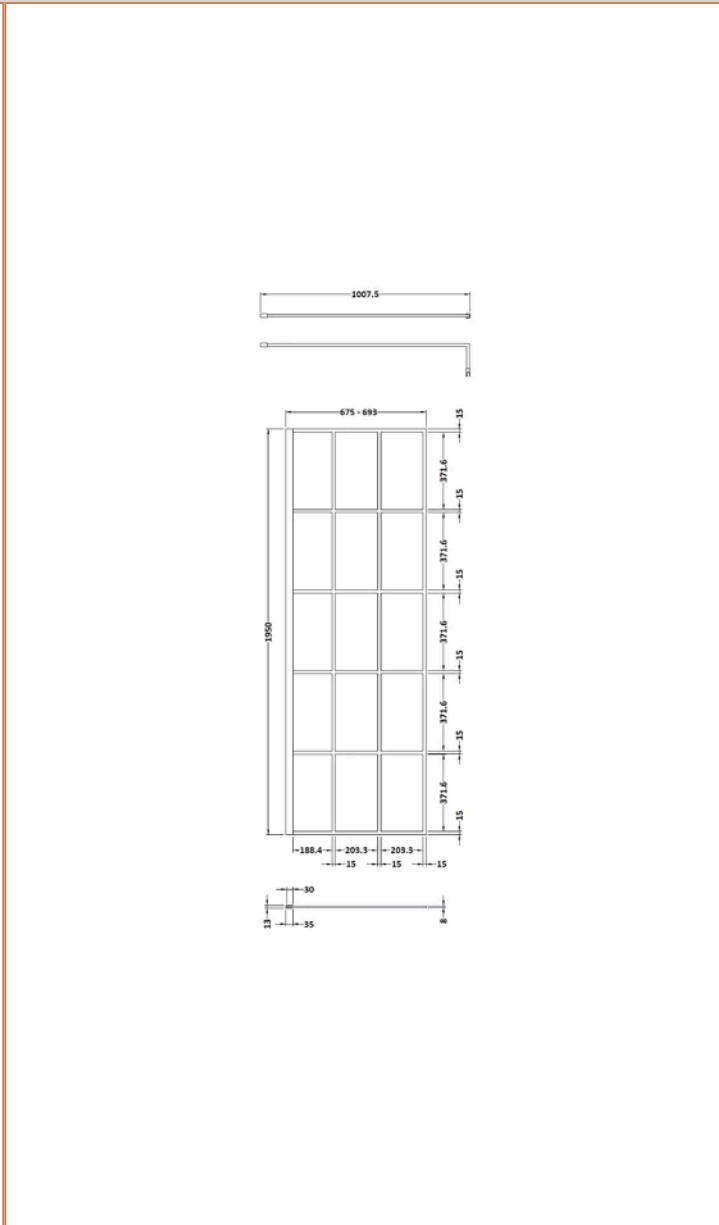
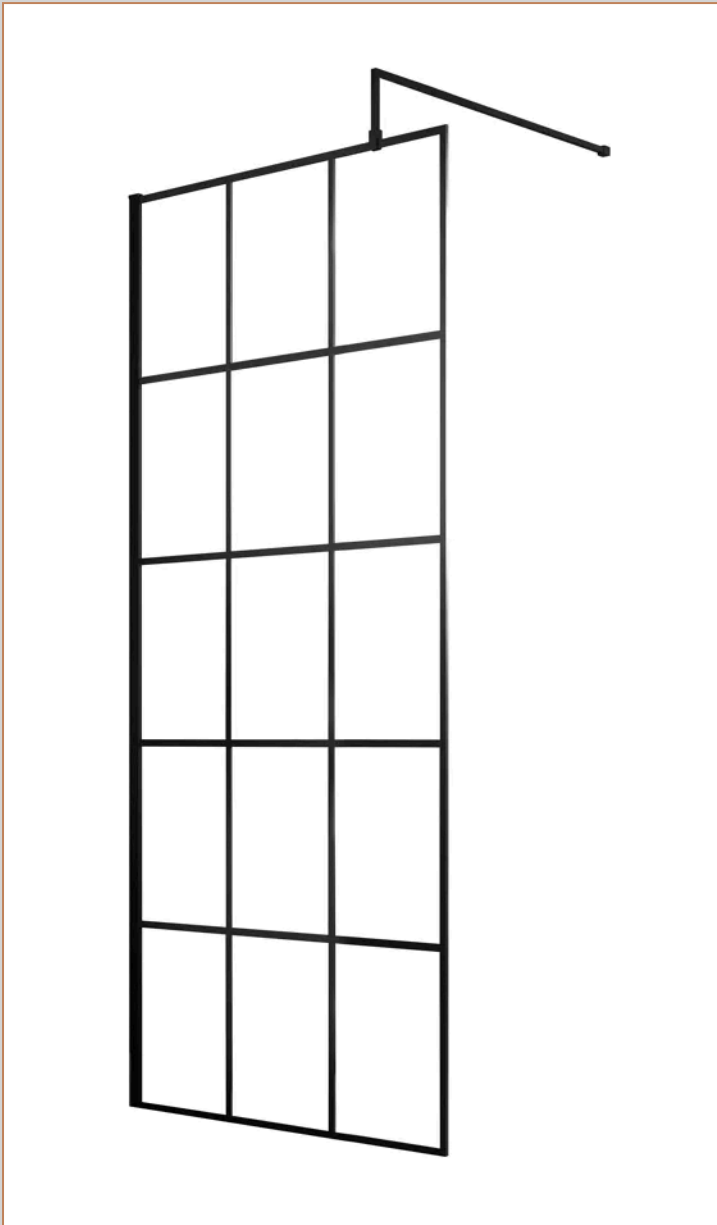

Product Dimensions

Product	1950 x 700 x 14mm (H x W x D)
Packaged	60 x 750 x 2070mm (H x W x D)
Nett Weight	31.1 kg
Packaged Weight	31.1 kg

Product Details

Country of Origin	China
Product Material	Aluminium
Colour/Finish	Matt Black
Style	Contemporary
Fixings Included	Yes
Easy Clean	Yes
Adjustment Max	693
Adjustment Min	675
Ce Certified	Yes
Declaration Of Performance	Yes
Easy Fit	No
Enclosure Design	Framed
Frame Finish	Matt Black
Glass Thickness	8 mm
Handles Included	No
Support Bar Included	Yes
Ukca Certified	Yes

Sales Code: NTP011

Barcode: 5055369025381

Brand: nuie

Description: nuie 1200 x 700mm Rectangular Shower Tray

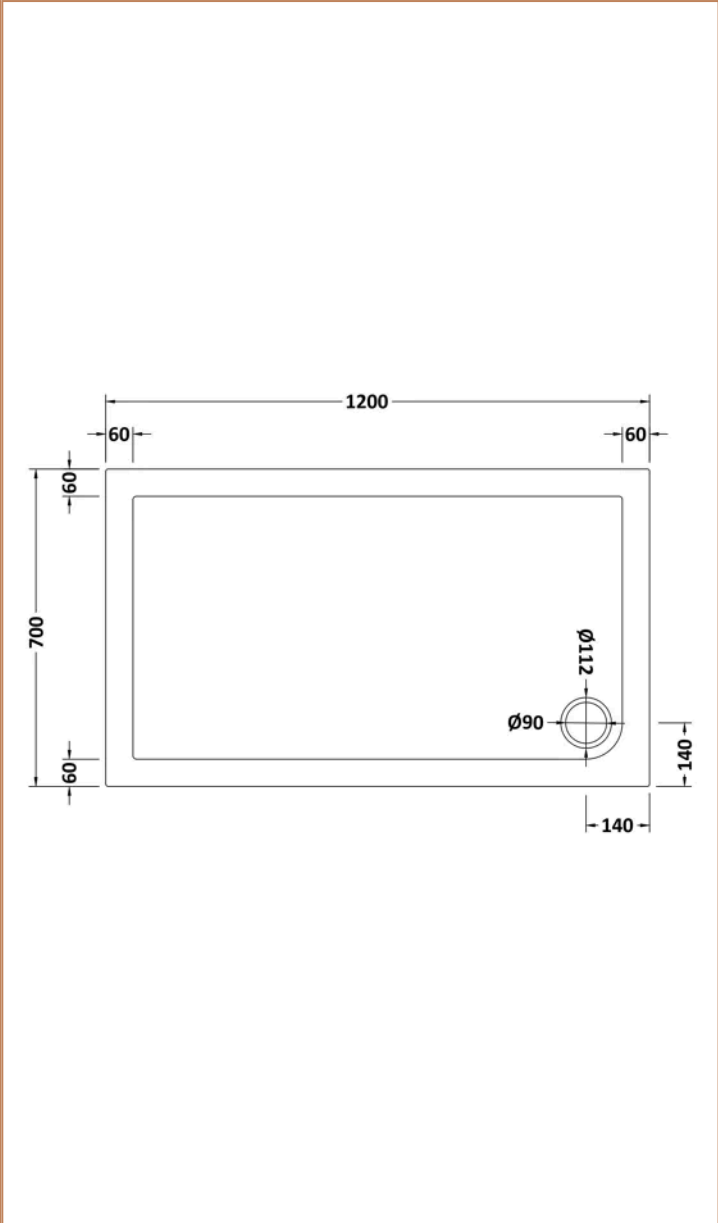

Product Dimensions

Product	40 x 700 x 1200mm (H x W x L)
Packaged	80 x 740 x 1240mm (H x W x D)
Nett Weight	26.4 kg
Packaged Weight	26.7 kg

Product Details

Country of Origin	United Kingdom
Product Material	Acrylic Capped Abs Caco3 And Pu
Colour/Finish	White
Style	Contemporary
Fixings Included	No
Ce Certified	Yes
Leg Set Included	No
Legs Included	No
Raised Edge	Yes
Slip Resistant	No
Waste Included	No
Waste Size Required	90mm

Sales Code: ENZW008

Barcode: 5056678428801

Brand: nuie

Description: nuie 800mm Framed Walk-In Wetroom Screen Set With Tray



Technical Drawing Not Available

Product Dimensions

Product	1950 x 800 x 14mm (H x W x D)
Nett Weight	92 kg
Packaged Weight	92 kg

Product Details

Country of Origin	China
Product Material	Acrylic Capped Abs Caco3 And Pu,Aluminium,Glass
Colour/Finish	Matt Black
Style	Contemporary
Ce Certified	Yes
Enclosure Design	Framed
Glass Thickness	8 mm
Waste Included	No

Sales Code: WRSF070

Barcode: 5056211806882

Brand: Hudson Reed

Description: Hudson Reed 700mm Framed Matrix Matt Black Wetroom Screen

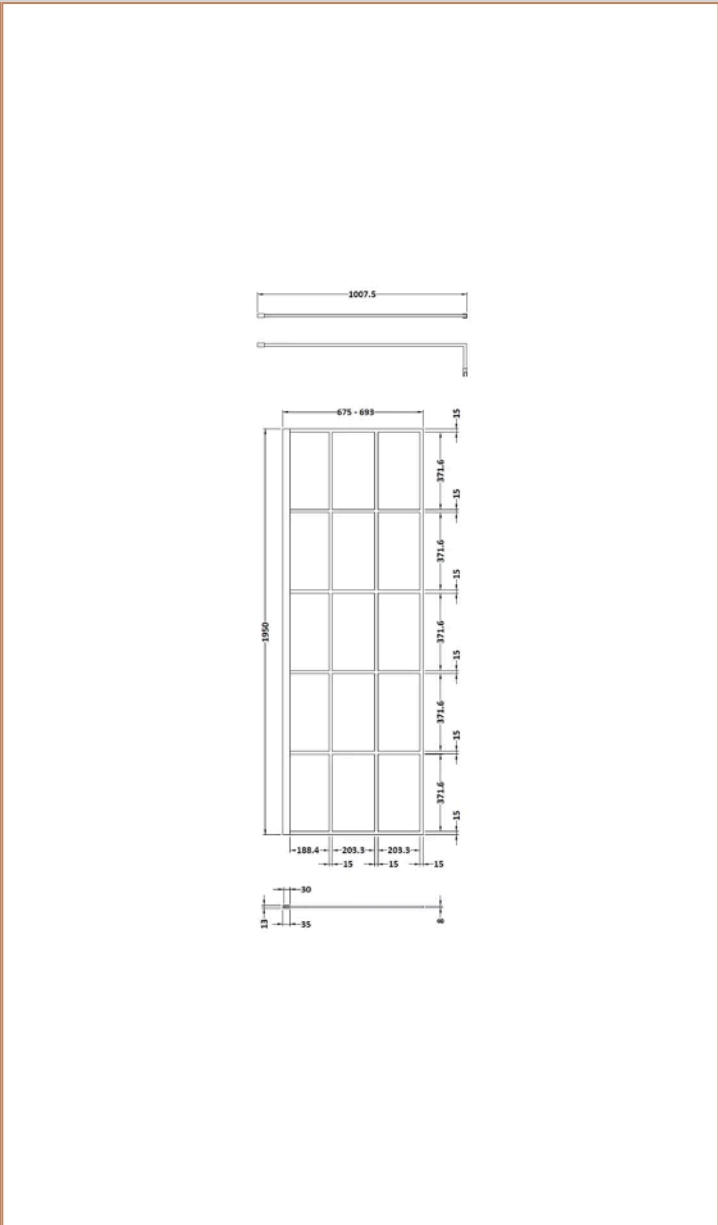
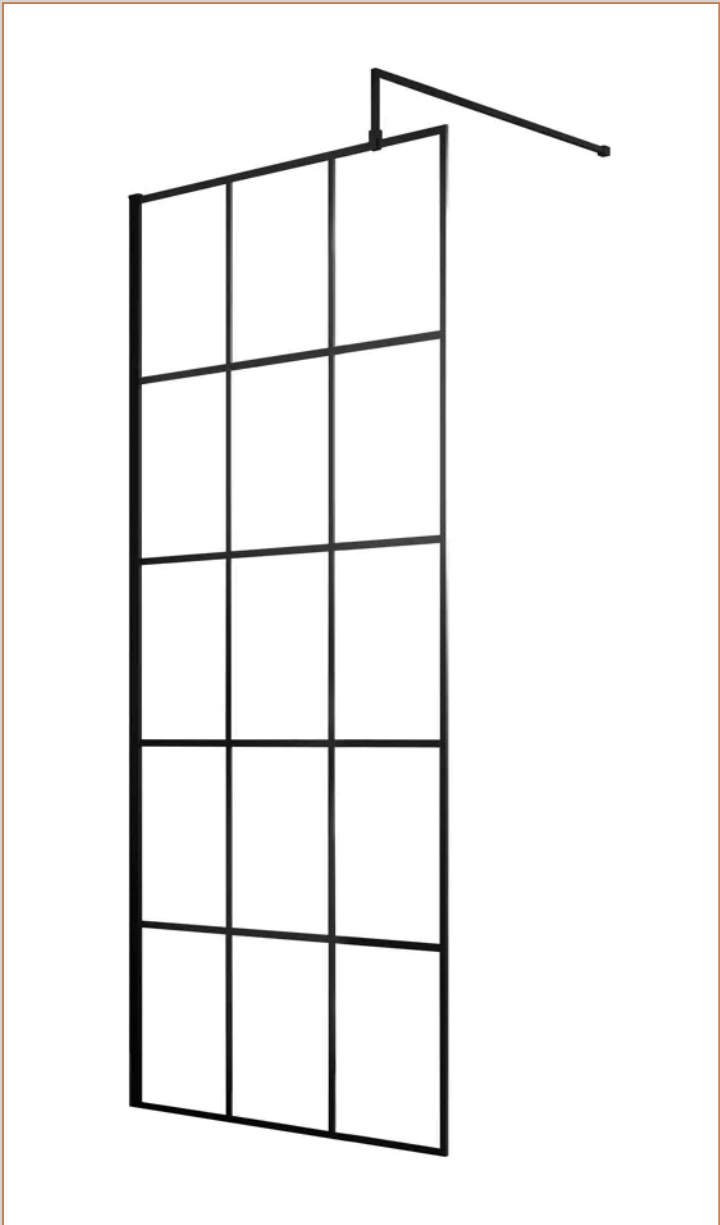

Product Dimensions

Product	1950 x 700 x 14mm (H x W x D)
Packaged	60 x 750 x 2070mm (H x W x D)
Nett Weight	31.1 kg
Packaged Weight	31.1 kg

Product Details

Country of Origin	China
Product Material	Aluminium
Colour/Finish	Matt Black
Style	Contemporary
Fixings Included	Yes
Easy Clean	Yes
Adjustment Max	693
Adjustment Min	675
Ce Certified	Yes
Declaration Of Performance	Yes
Easy Fit	No
Enclosure Design	Framed
Frame Finish	Matt Black
Glass Thickness	8 mm
Handles Included	No
Support Bar Included	Yes
Ukca Certified	Yes

Sales Code: NTP023

Barcode: 5055369006311

Brand: nuie

Description: nuie 1200 x 800mm Rectangular Shower Tray

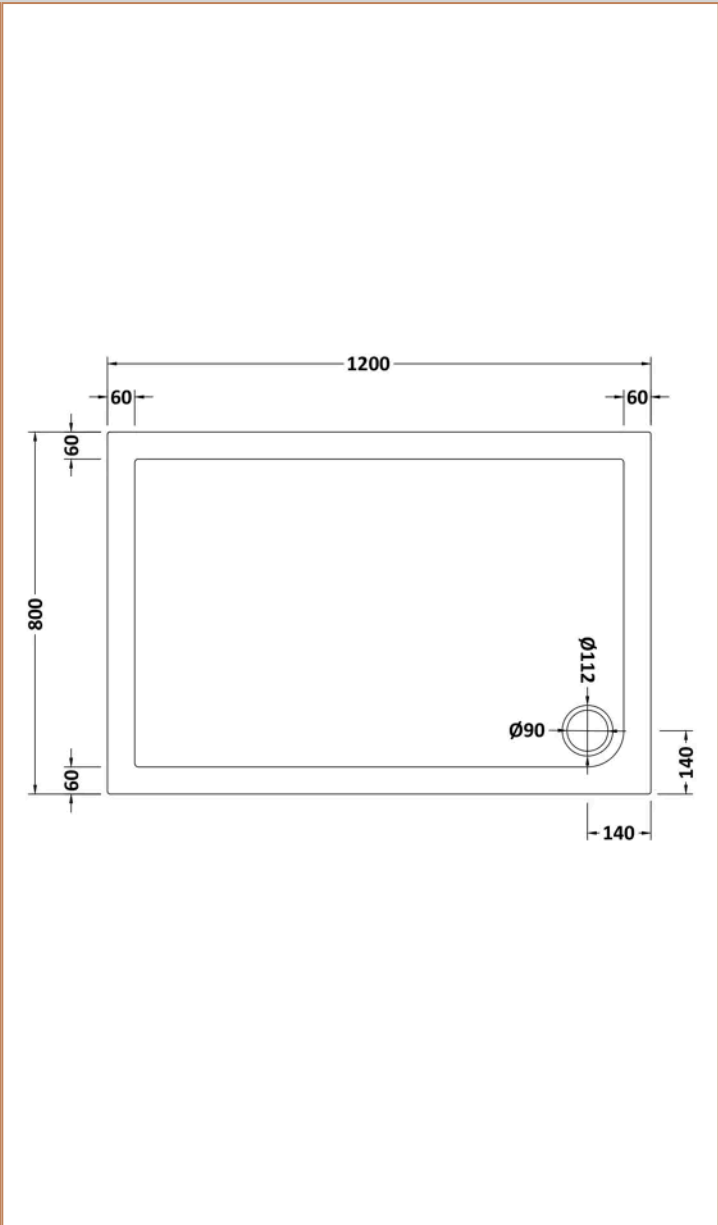

Product Dimensions

Product	40 x 800 x 1200mm (H x W x L)
Packaged	80 x 840 x 1240mm (H x W x D)
Nett Weight	29.8 kg
Packaged Weight	30.1 kg

Product Details

Country of Origin	United Kingdom
Product Material	Acrylic Capped Abs Caco3 And Pu
Colour/Finish	White
Style	Contemporary
Fixings Included	No
Ce Certified	Yes
Leg Set Included	No
Legs Included	No
Raised Edge	Yes
Slip Resistant	No
Waste Included	No
Waste Size Required	90mm

Sales Code: ENZW012

Barcode: 5056678428764

Brand: nuie

Description: nuie 900mm Framed Walk-In Wetroom Screen Set With Tray



Technical Drawing Not Available

Product Dimensions

Product	1950 x 900 x 14mm (H x W x D)
Nett Weight	98.8 kg
Packaged Weight	98.8 kg

Product Details

Country of Origin	China
Product Material	Acrylic Capped Abs Caco3 And Pu,Aluminium,Glass
Colour/Finish	Matt Black
Style	Contemporary
Ce Certified	Yes
Enclosure Design	Framed
Glass Thickness	8 mm
Waste Included	No

Sales Code: WRSF070

Barcode: 5056211806882

Brand: Hudson Reed

Description: Hudson Reed 700mm Framed Matrix Matt Black Wetroom Screen

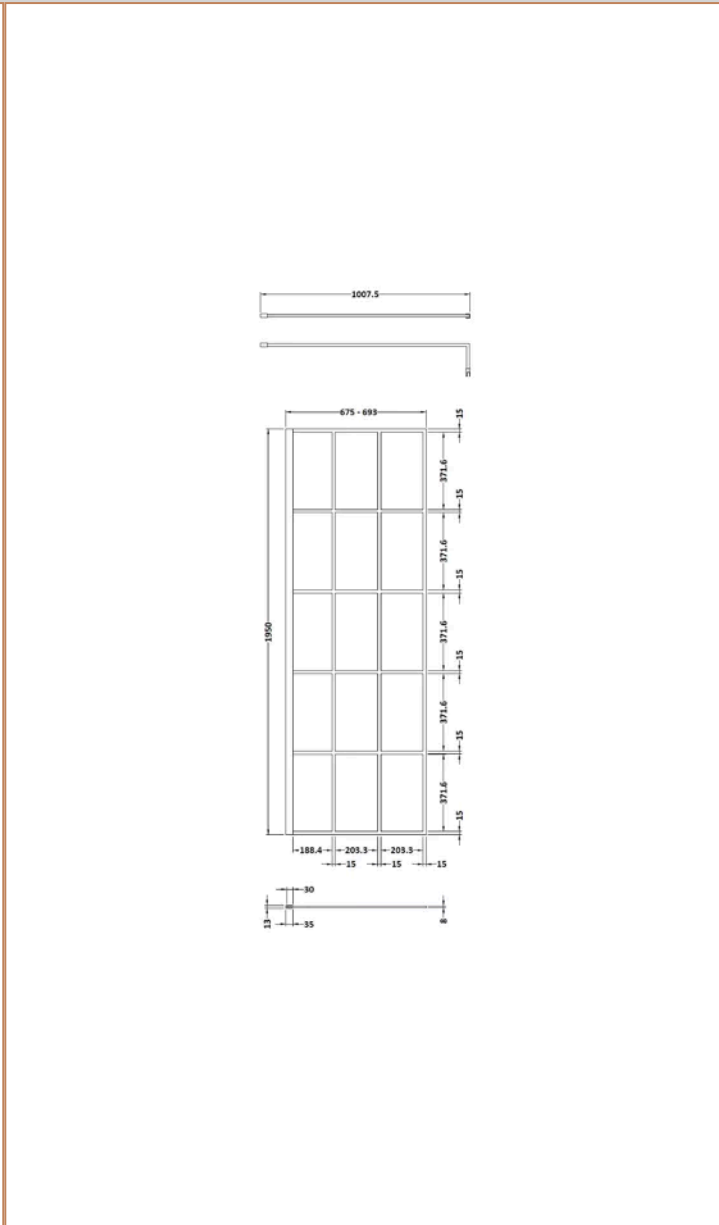
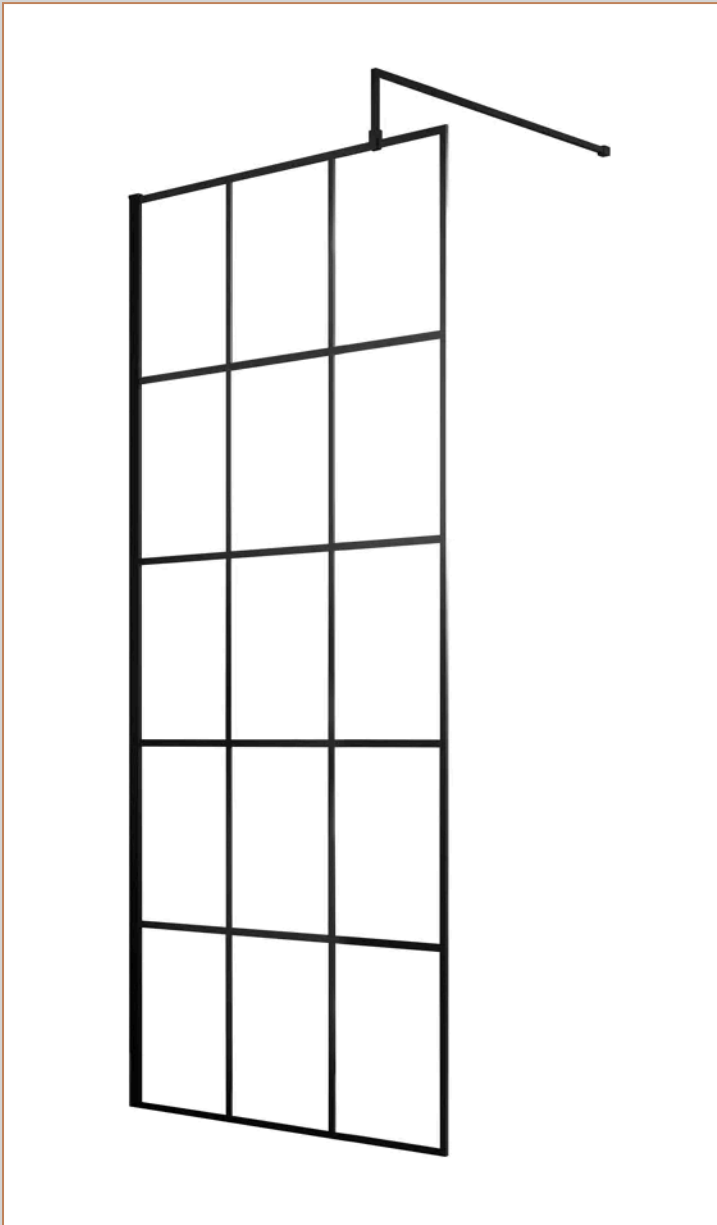

Product Dimensions

Product	1950 x 700 x 14mm (H x W x D)
Packaged	60 x 750 x 2070mm (H x W x D)
Nett Weight	31.1 kg
Packaged Weight	31.1 kg

Product Details

Country of Origin	China
Product Material	Aluminium
Colour/Finish	Matt Black
Style	Contemporary
Fixings Included	Yes
Easy Clean	Yes
Adjustment Max	693
Adjustment Min	675
Ce Certified	Yes
Declaration Of Performance	Yes
Easy Fit	No
Enclosure Design	Framed
Frame Finish	Matt Black
Glass Thickness	8 mm
Handles Included	No
Support Bar Included	Yes
Ukca Certified	Yes

Sales Code: WRSF090

Barcode: 5056211806912

Brand: Hudson Reed

Description: Hudson Reed 900mm Matt Black Matrix Framed Wetroom Screen

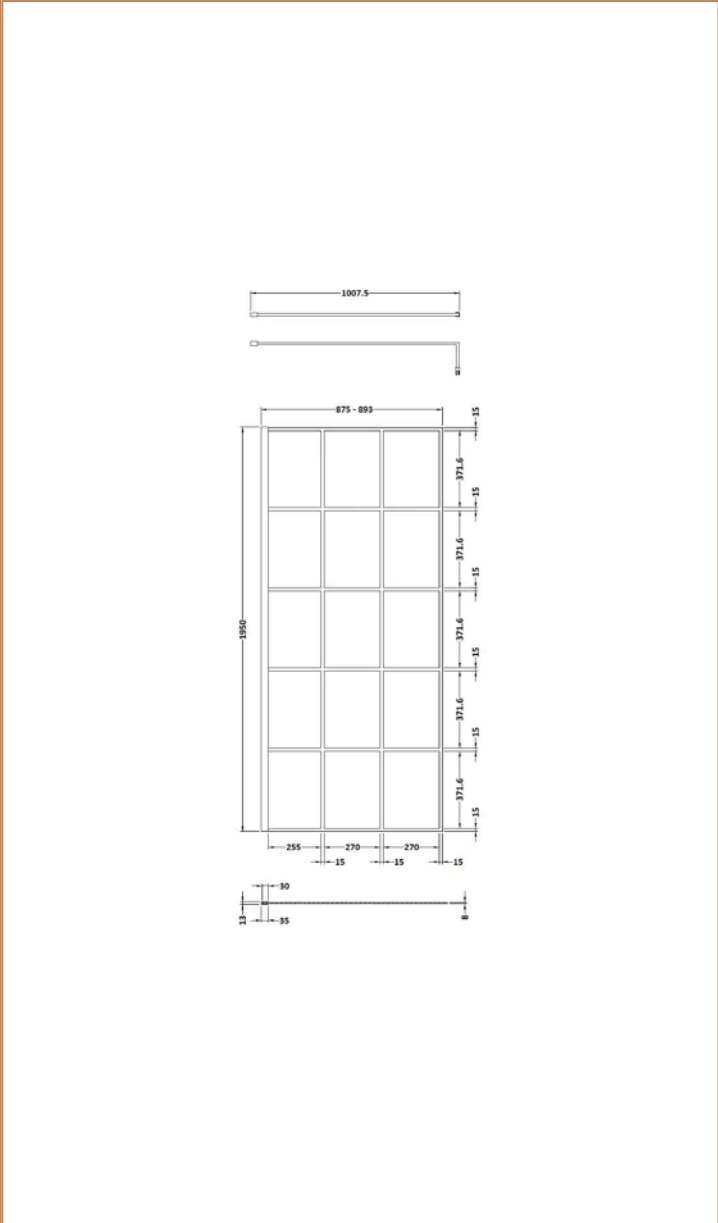
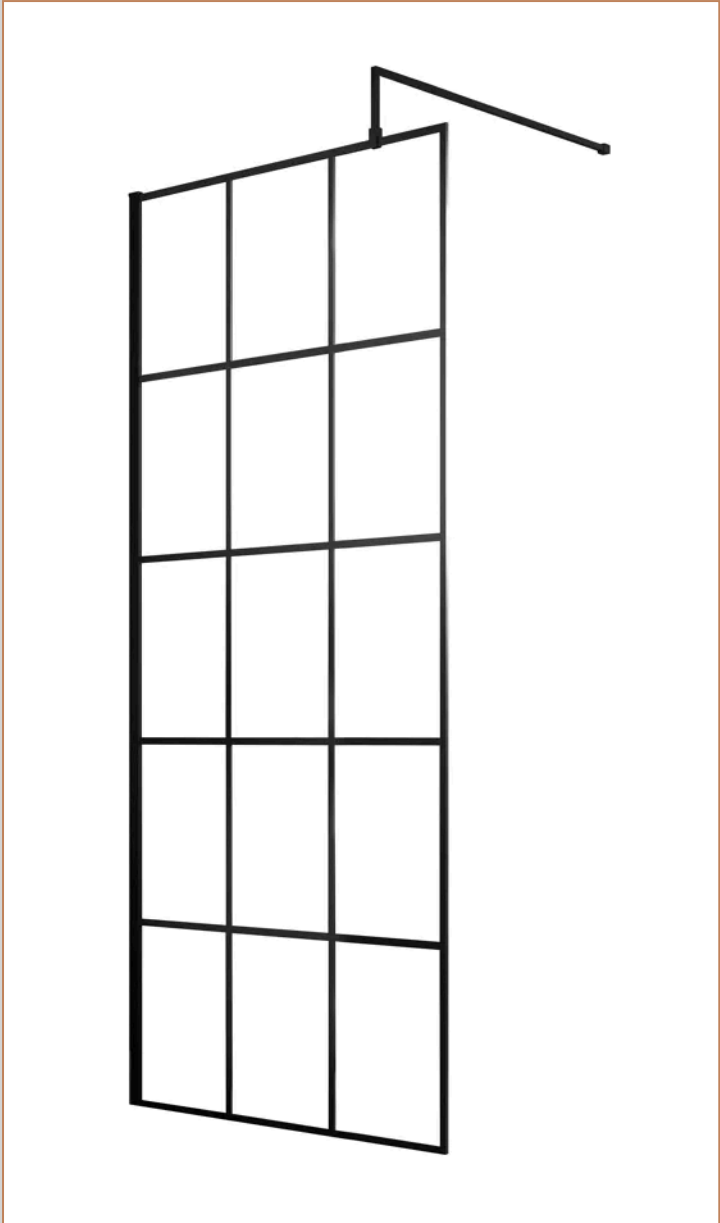

Product Dimensions

Product	1950 x 900 x 14mm (H x W x D)
Packaged	60 x 950 x 2070mm (H x W x D)
Nett Weight	40.3 kg
Packaged Weight	40.3 kg

Product Details

Country of Origin	China
Product Material	Aluminium
Colour/Finish	Matt Black
Style	Contemporary
Fixings Included	Yes
Easy Clean	Yes
Adjustment Max	893
Adjustment Min	875
Ce Certified	Yes
Declaration Of Performance	Yes
Easy Fit	No
Enclosure Design	Framed
Frame Finish	Matt Black
Glass Thickness	8 mm
Handles Included	No
Support Bar Included	Yes
Ukca Certified	Yes

Sales Code: NTP024

Barcode: 5055369006328

Brand: nuie

Description: nuie 1200 x 900mm Rectangular Shower Tray

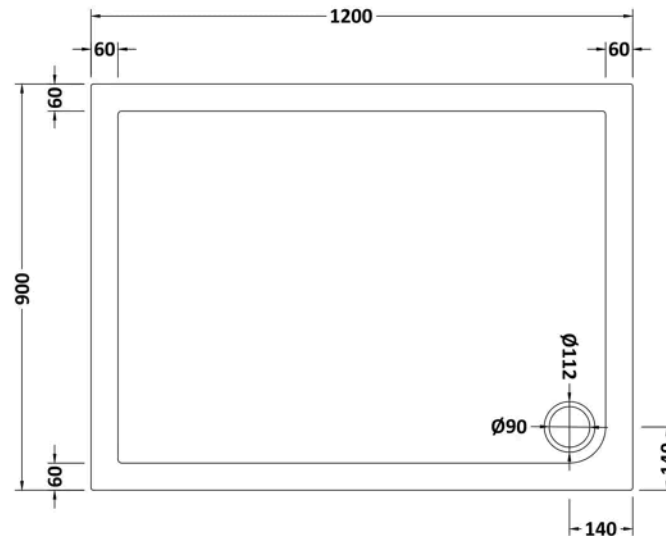

Product Dimensions

Product	40 x 900 x 1200mm (H x W x L)
Packaged	80 x 940 x 1240mm (H x W x D)
Nett Weight	31.7 kg
Packaged Weight	32 kg

Product Details

Country of Origin	United Kingdom
Product Material	Acrylic Capped Abs Caco3 And Pu
Colour/Finish	White
Style	Contemporary
Fixings Included	No
Ce Certified	Yes
Leg Set Included	No
Legs Included	No
Raised Edge	Yes
Slip Resistant	No
Waste Included	No
Waste Size Required	90mm

Sales Code: ENZW016

Barcode: 5056678428726

Brand: nuie

Description: nuie 900mm Framed Walk-In Wetroom Screen Set With Tray

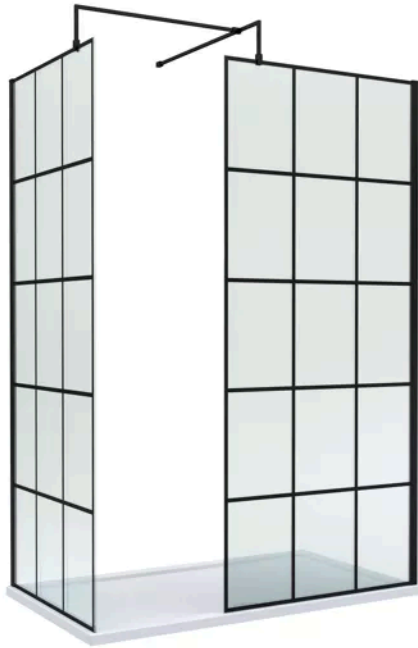

Technical Drawing Not Available

Product Dimensions

Product	1950 x 900 x 14mm (H x W x D)
Nett Weight	97.4 kg
Packaged Weight	97.4 kg

Product Details

Country of Origin	China
Product Material	Acrylic Capped Abs Caco3 And Pu,Aluminium,Glass
Colour/Finish	Matt Black
Style	Contemporary
Ce Certified	Yes
Enclosure Design	Framed
Glass Thickness	8 mm
Waste Included	No

Sales Code: WRSF070

Barcode: 5056211806882

Brand: Hudson Reed

Description: Hudson Reed 700mm Framed Matrix Matt Black Wetroom Screen

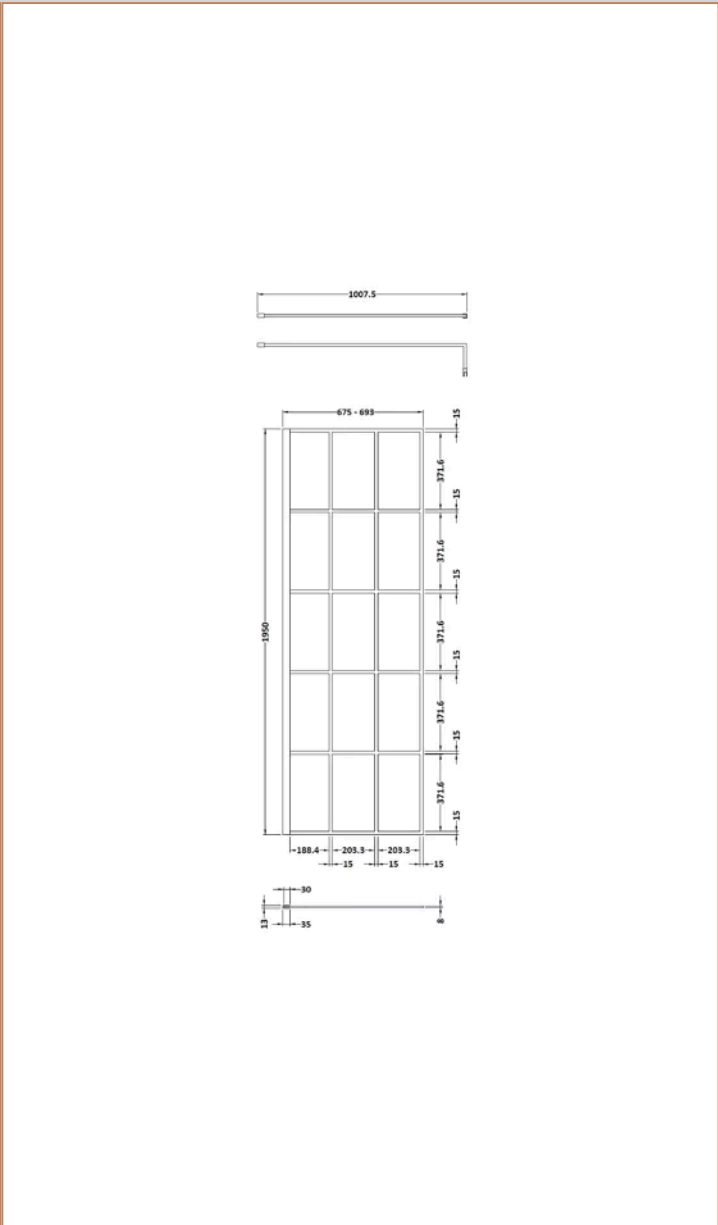
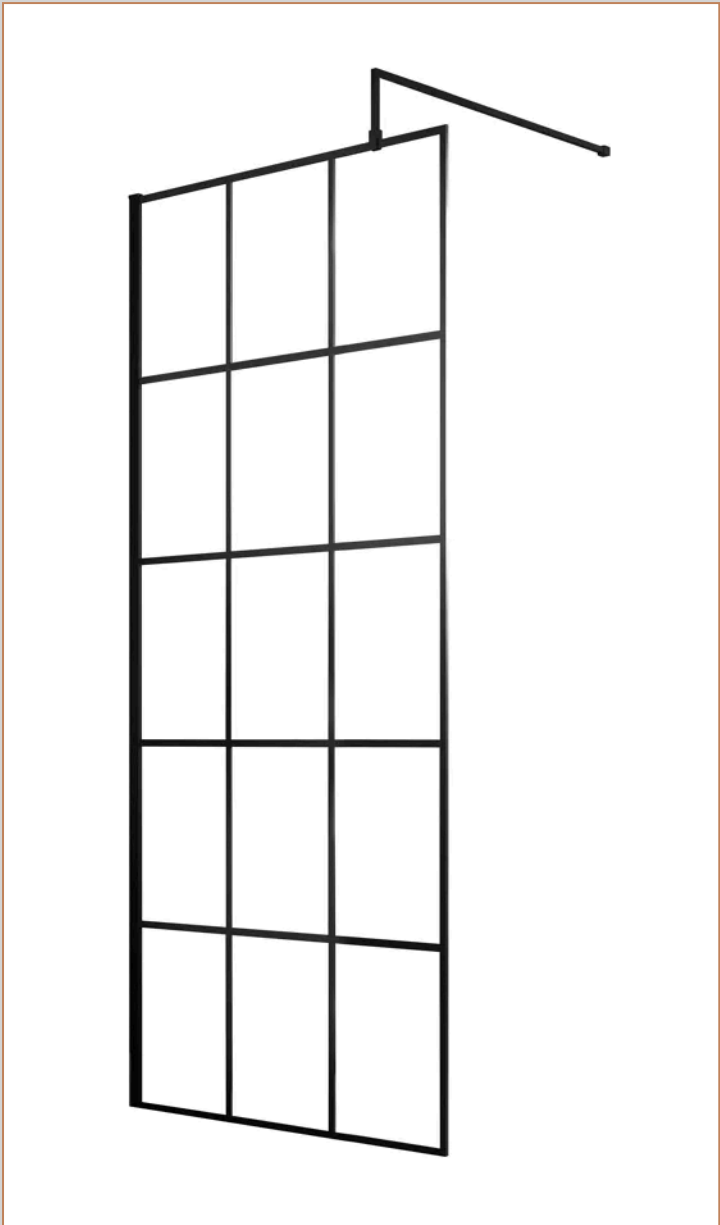

Product Dimensions

Product	1950 x 700 x 14mm (H x W x D)
Packaged	60 x 750 x 2070mm (H x W x D)
Nett Weight	31.1 kg
Packaged Weight	31.1 kg

Product Details

Country of Origin	China
Product Material	Aluminium
Colour/Finish	Matt Black
Style	Contemporary
Fixings Included	Yes
Easy Clean	Yes
Adjustment Max	693
Adjustment Min	675
Ce Certified	Yes
Declaration Of Performance	Yes
Easy Fit	No
Enclosure Design	Framed
Frame Finish	Matt Black
Glass Thickness	8 mm
Handles Included	No
Support Bar Included	Yes
Ukca Certified	Yes

Sales Code: WRSF090

Barcode: 5056211806912

Brand: Hudson Reed

Description: Hudson Reed 900mm Matt Black Matrix Framed Wetroom Screen

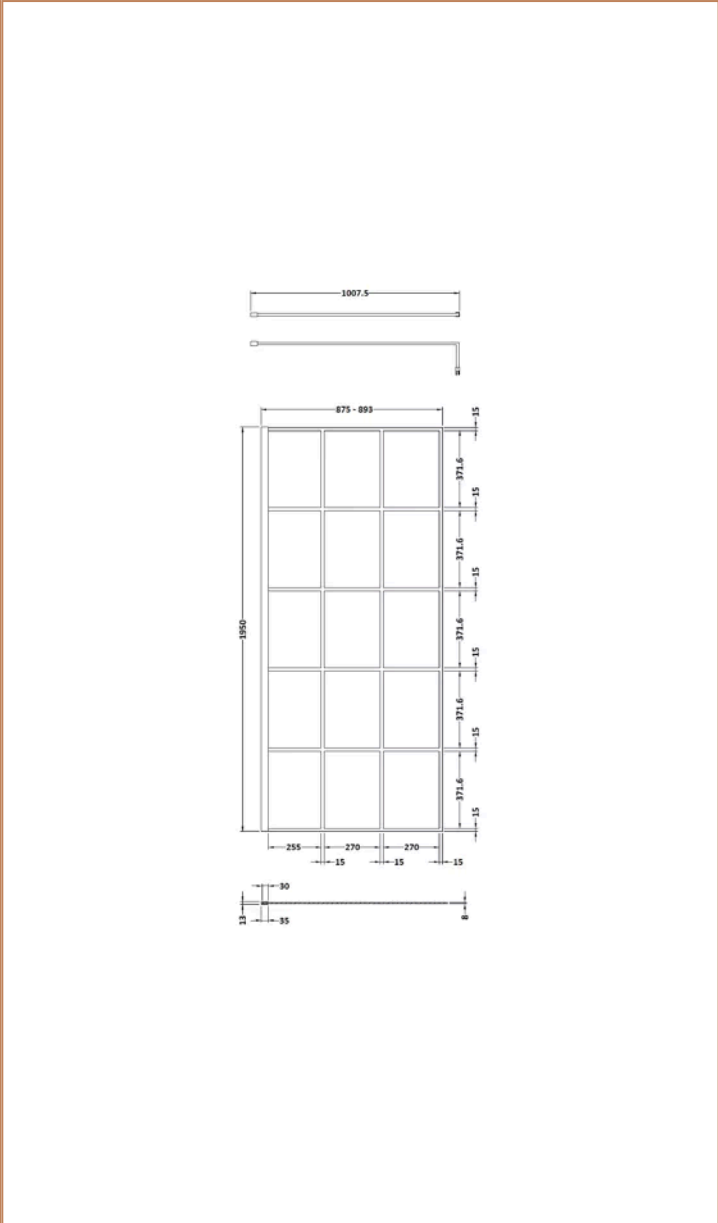
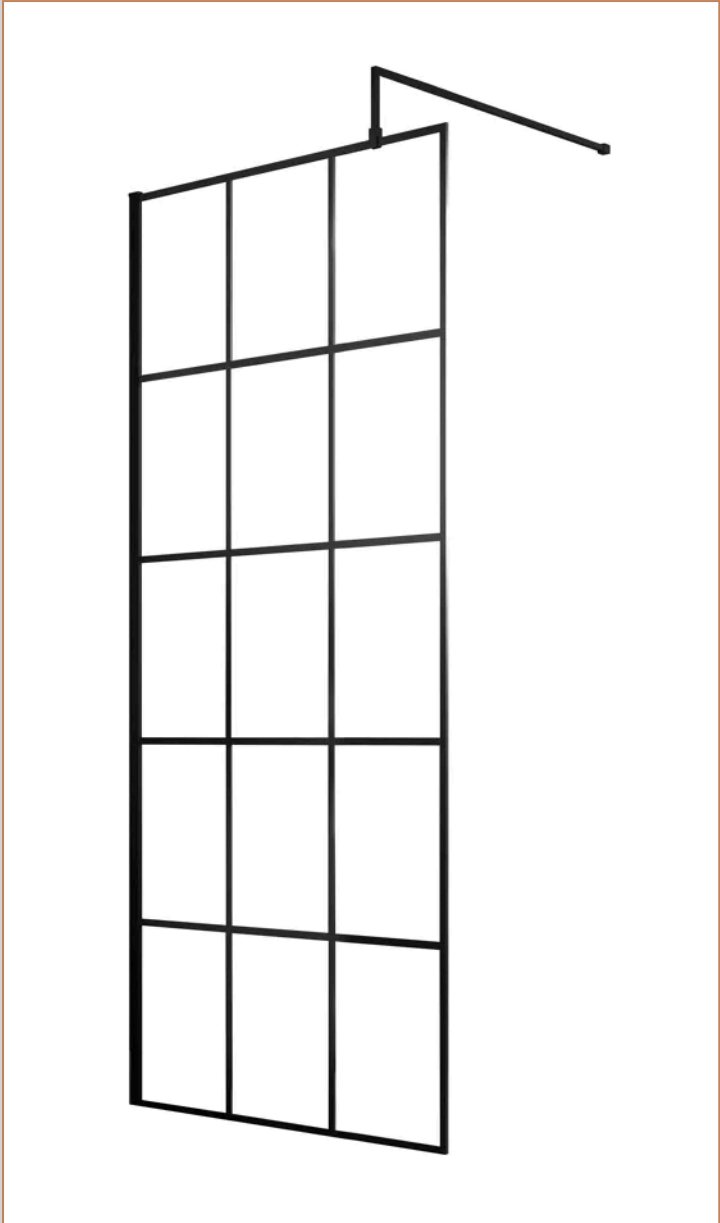

Product Dimensions

Product	1950 x 900 x 14mm (H x W x D)
Packaged	60 x 950 x 2070mm (H x W x D)
Nett Weight	40.3 kg
Packaged Weight	40.3 kg

Product Details

Country of Origin	China
Product Material	Aluminium
Colour/Finish	Matt Black
Style	Contemporary
Fixings Included	Yes
Easy Clean	Yes
Adjustment Max	893
Adjustment Min	875
Ce Certified	Yes
Declaration Of Performance	Yes
Easy Fit	No
Enclosure Design	Framed
Frame Finish	Matt Black
Glass Thickness	8 mm
Handles Included	No
Support Bar Included	Yes
Ukca Certified	Yes

Sales Code: NTP031

Barcode: 5055369071180

Brand: nuie

Description: 1400 x 700mm Rectangular Shower Tray

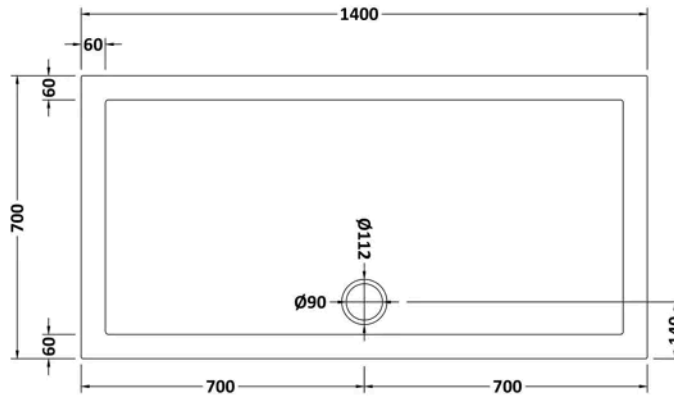

Product Dimensions

Product	40 x 700 x 1400mm (H x W x L)
Packaged	80 x 740 x 1440mm (H x W x D)
Nett Weight	30.8 kg
Packaged Weight	31.1 kg

Product Details

Country of Origin	United Kingdom
Product Material	Acrylic Capped Abs Caco3 And Pu
Colour/Finish	White
Style	Contemporary
Fixings Included	No
Ce Certified	Yes
Leg Set Included	No
Legs Included	No
Raised Edge	Yes
Slip Resistant	No
Waste Included	No
Waste Size Required	90mm

Sales Code: ENZW020

Barcode: 5056678428689

Brand: nuie

Description: nuie 900mm Framed Walk-In Wetroom Screen Set With Tray

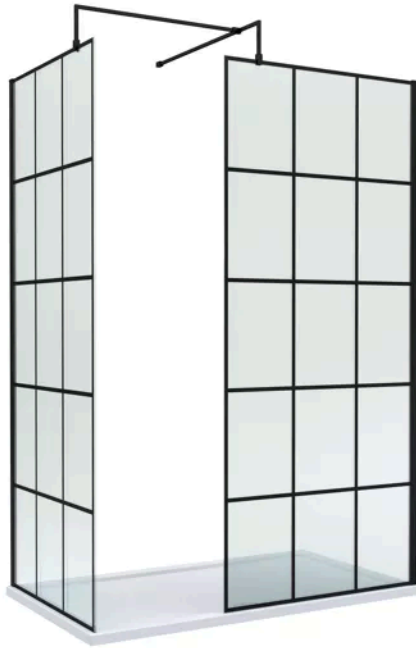

Technical Drawing Not Available

Product Dimensions

Product	1950 x 900 x 14mm (H x W x D)
Nett Weight	110.2 kg
Packaged Weight	110.2 kg

Product Details

Country of Origin	China
Product Material	Acrylic Capped Abs Caco3 And Pu,Aluminium,Glass
Colour/Finish	Matt Black
Style	Contemporary
Ce Certified	Yes
Enclosure Design	Framed
Glass Thickness	8 mm
Waste Included	No

Sales Code: WRSF080

Barcode: 5056211806905

Brand: Hudson Reed

Description: Hudson Reed 800mm Framed Matrix Matt Black Wetroom Screen

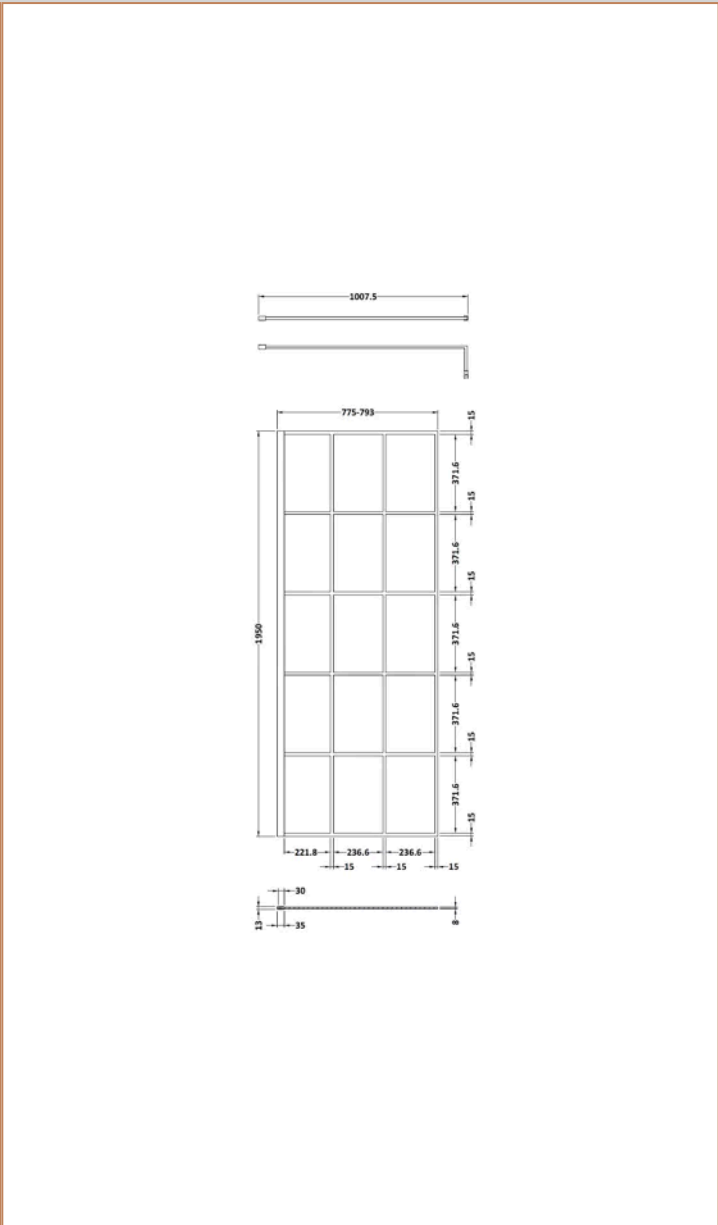
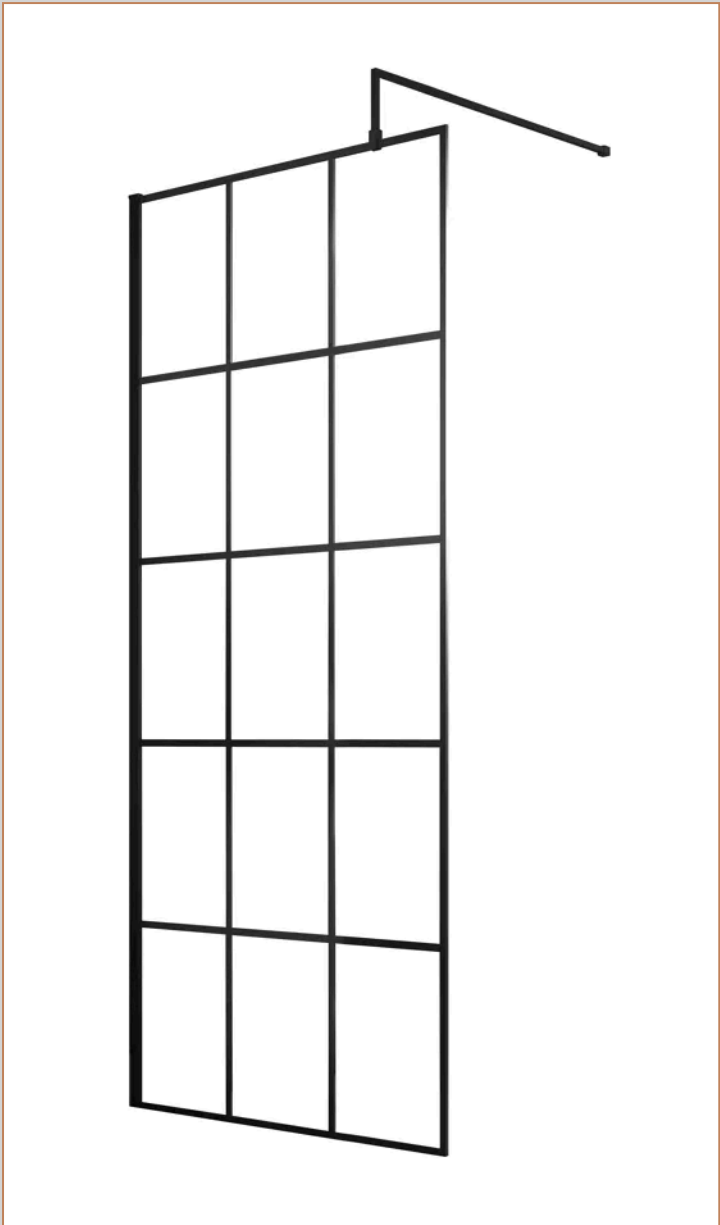

Product Dimensions

Product	1950 x 800 x 14mm (H x W x D)
Packaged	60 x 850 x 2070mm (H x W x D)
Nett Weight	35.9 kg
Packaged Weight	35.9 kg

Product Details

Country of Origin	China
Product Material	Aluminium
Colour/Finish	Matt Black
Style	Contemporary
Fixings Included	Yes
Easy Clean	Yes
Adjustment Max	793
Adjustment Min	775
Ce Certified	Yes
Declaration Of Performance	Yes
Easy Fit	No
Enclosure Design	Framed
Frame Finish	Matt Black
Glass Thickness	8 mm
Handles Included	No
Support Bar Included	Yes
Ukca Certified	Yes

Sales Code: WRSF090

Barcode: 5056211806912

Brand: Hudson Reed

Description: Hudson Reed 900mm Matt Black Matrix Framed Wetroom Screen

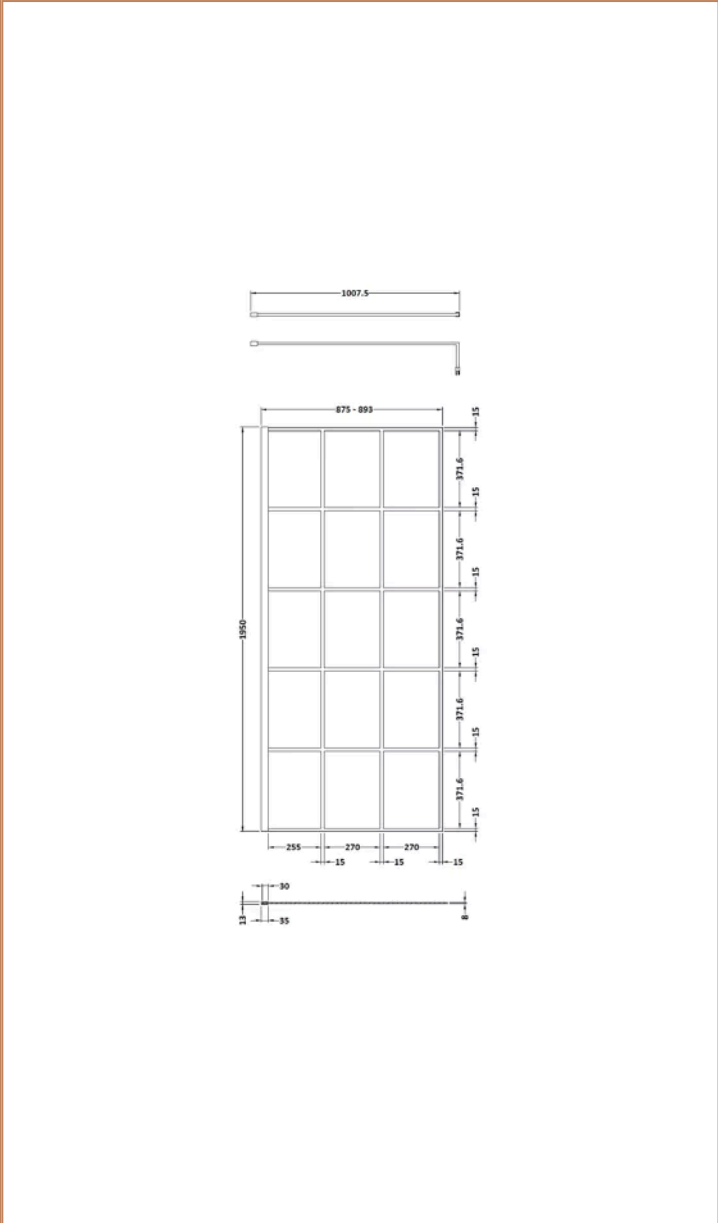
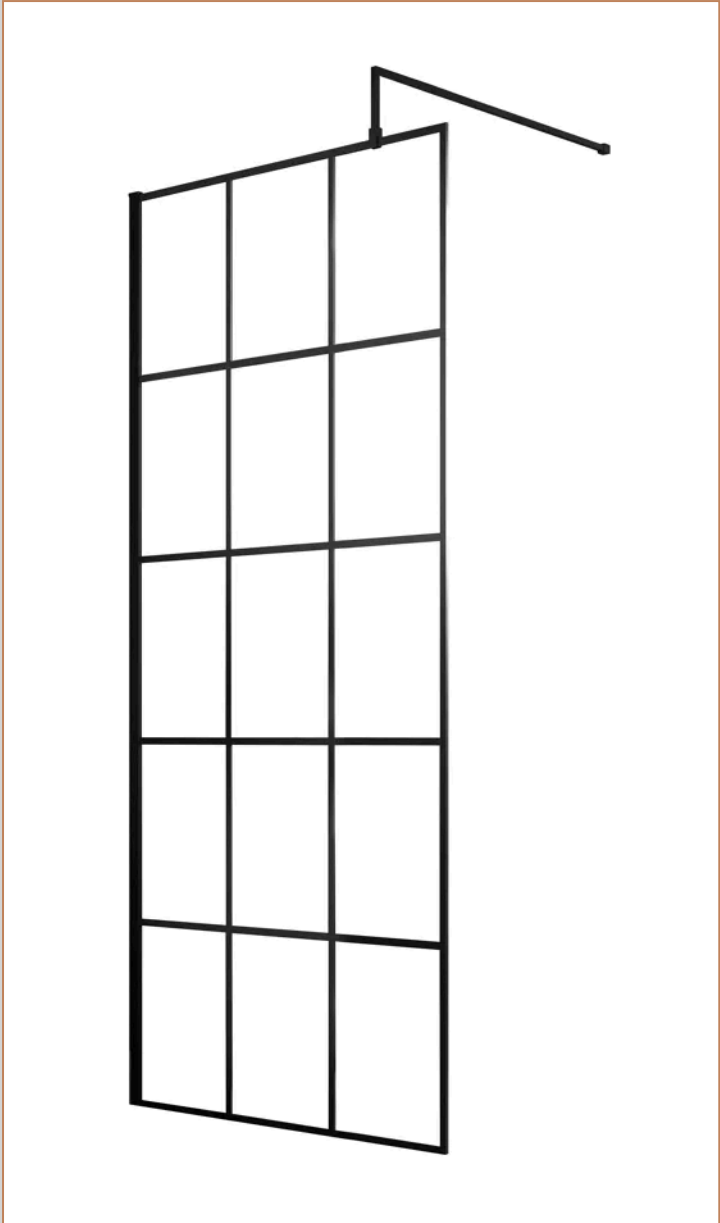

Product Dimensions

Product	1950 x 900 x 14mm (H x W x D)
Packaged	60 x 950 x 2070mm (H x W x D)
Nett Weight	40.3 kg
Packaged Weight	40.3 kg

Product Details

Country of Origin	China
Product Material	Aluminium
Colour/Finish	Matt Black
Style	Contemporary
Fixings Included	Yes
Easy Clean	Yes
Adjustment Max	893
Adjustment Min	875
Ce Certified	Yes
Declaration Of Performance	Yes
Easy Fit	No
Enclosure Design	Framed
Frame Finish	Matt Black
Glass Thickness	8 mm
Handles Included	No
Support Bar Included	Yes
Ukca Certified	Yes

Sales Code: NTP033

Barcode: 5055369006335

Brand: nuie

Description: 1400 x 800mm Rectangular Slimline Shower Tray

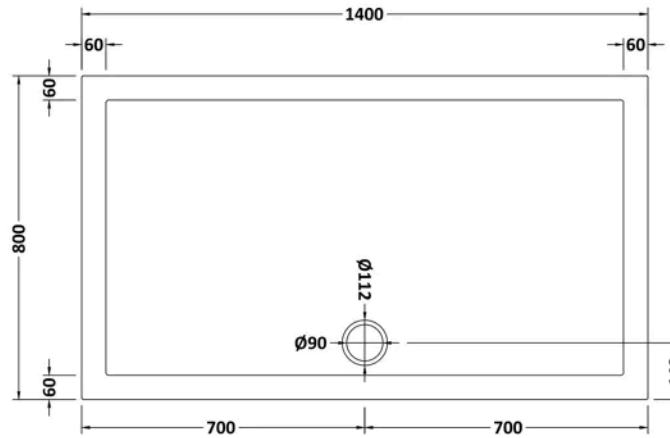

Product Dimensions

Product	40 x 800 x 1400mm (H x W x L)
Packaged	80 x 840 x 1440mm (H x W x D)
Nett Weight	36.6 kg
Packaged Weight	36.9 kg

Product Details

Country of Origin	United Kingdom
Product Material	Acrylic Capped Abs Caco3 And Pu
Colour/Finish	White
Style	Contemporary
Fixings Included	No
Ce Certified	Yes
Leg Set Included	No
Legs Included	No
Raised Edge	Yes
Slip Resistant	No
Waste Included	No
Waste Size Required	90mm

Sales Code: ENZW027

Barcode: 5056678428610

Brand: nuie

Description: nuie 900mm Walk-In Matt Black Wetroom Screen Set With Tray

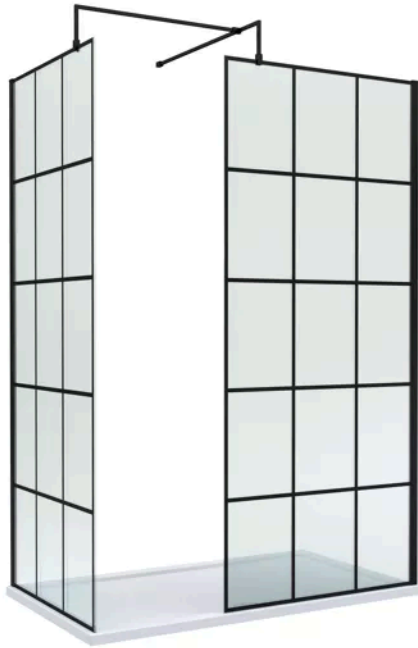

Technical Drawing Not Available

Product Dimensions

Product	1950 x 900 x 14mm (H x W x D)
Nett Weight	112 kg
Packaged Weight	112 kg

Product Details

Country of Origin	China
Product Material	Acrylic Capped Abs Caco3 And Pu,Aluminium,Glass
Colour/Finish	Matt Black
Style	Contemporary
Ce Certified	Yes
Glass Thickness	8 mm
Waste Included	No

Sales Code: WRSF090

Barcode: 5056211806912

Brand: Hudson Reed

Description: Hudson Reed 900mm Matt Black Matrix Framed Wetroom Screen

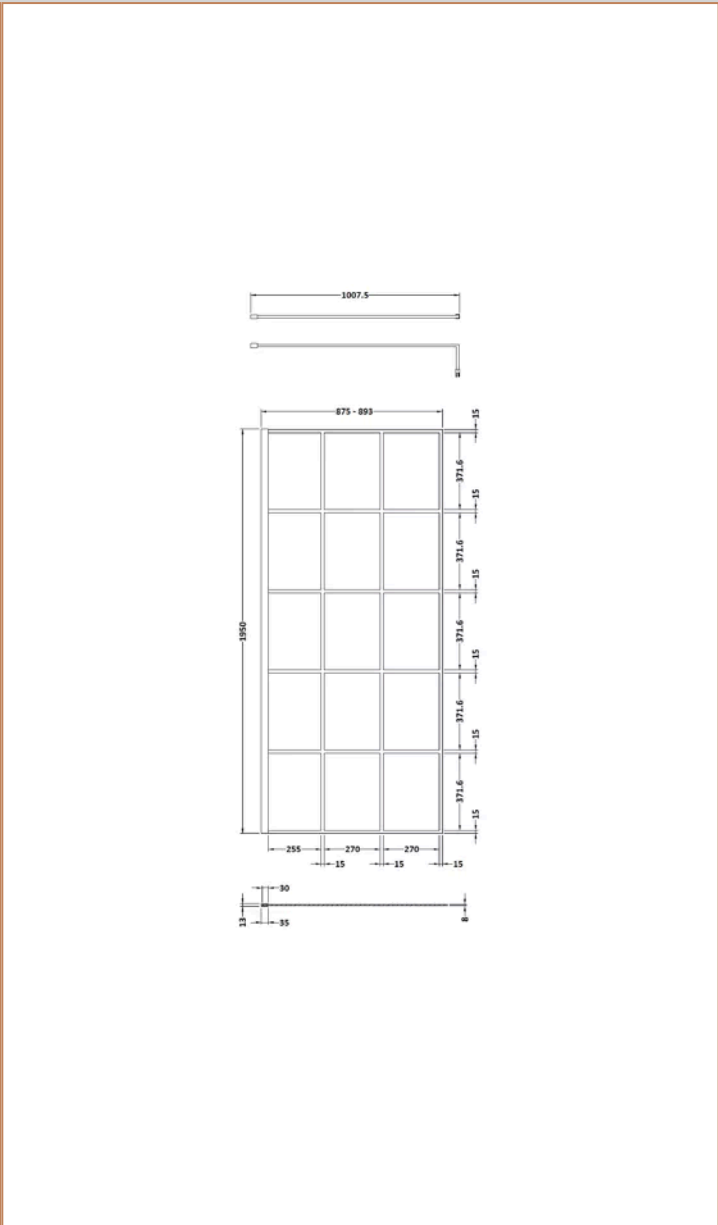
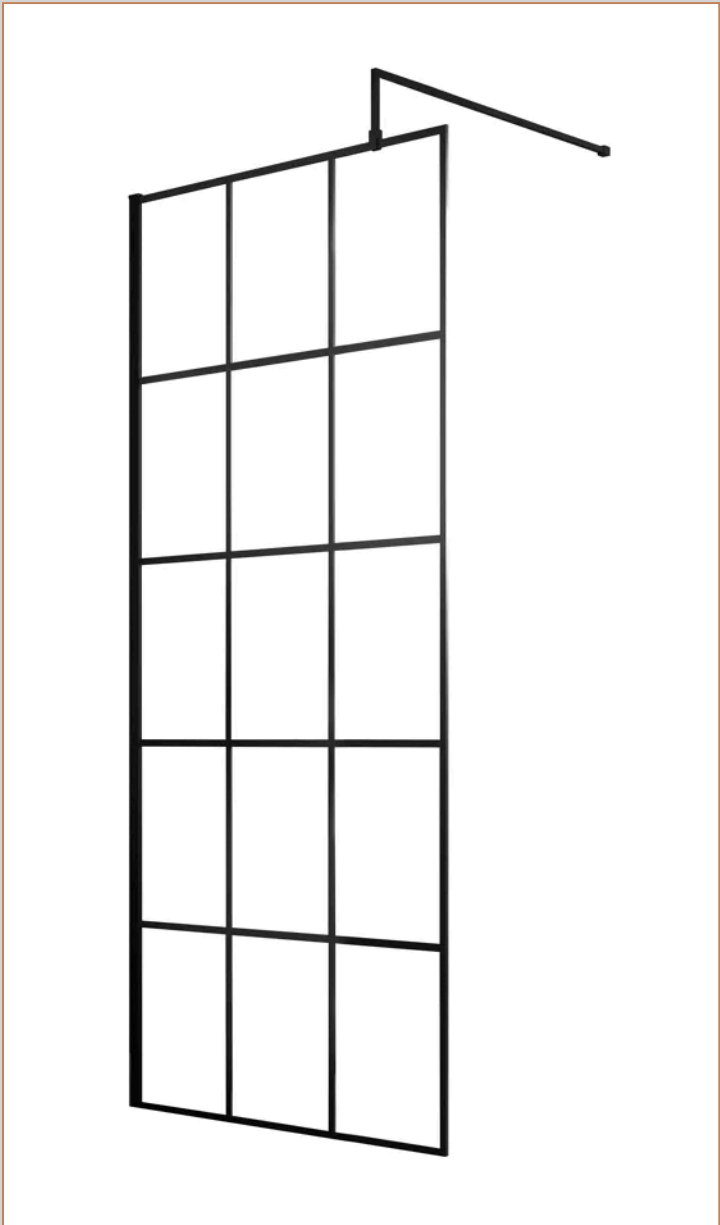

Product Dimensions

Product	1950 x 900 x 14mm (H x W x D)
Packaged	60 x 950 x 2070mm (H x W x D)
Nett Weight	40.3 kg
Packaged Weight	40.3 kg

Product Details

Country of Origin	China
Product Material	Aluminium
Colour/Finish	Matt Black
Style	Contemporary
Fixings Included	Yes
Easy Clean	Yes
Adjustment Max	893
Adjustment Min	875
Ce Certified	Yes
Declaration Of Performance	Yes
Easy Fit	No
Enclosure Design	Framed
Frame Finish	Matt Black
Glass Thickness	8 mm
Handles Included	No
Support Bar Included	Yes
Ukca Certified	Yes

Sales Code: NTP034

Barcode: 5055369006342

Brand: nuie

Description: 1400 x 900mm Rectangular Slimline Shower Tray

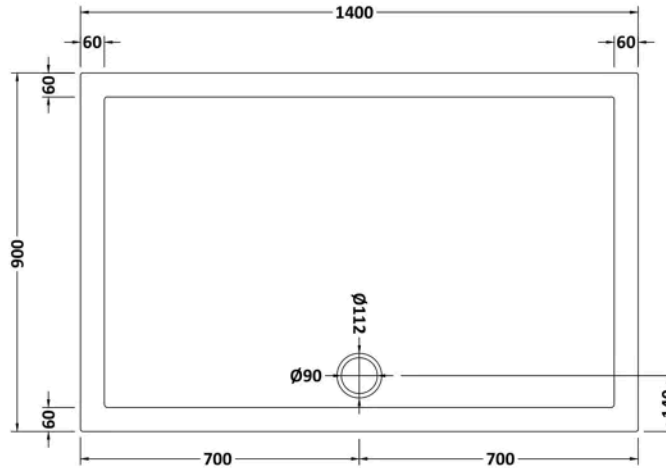

Product Dimensions

Product	40 x 900 x 1400mm (H x W x L)
Packaged	80 x 940 x 1440mm (H x W x D)
Nett Weight	36.8 kg
Packaged Weight	37.1 kg

Product Details

Country of Origin	United Kingdom
Product Material	Acrylic Capped Abs Caco3 And Pu
Colour/Finish	White
Style	Contemporary
Fixings Included	No
Ce Certified	Yes
Leg Set Included	No
Legs Included	No
Raised Edge	Yes
Slip Resistant	No
Waste Included	No
Waste Size Required	90mm

Sales Code: ENZW034

Barcode: 5056678428542

Brand: nuie

Description: nuie 1200mm Framed Walk-In Wetroom Screen Set With Tray



Technical Drawing Not Available

Product Dimensions

Product	1950 x 1200 x 14mm (H x W x D)
Nett Weight	116.5 kg
Packaged Weight	116.5 kg

Product Details

Country of Origin	China
Product Material	Acrylic Capped Abs Caco3 And Pu,Aluminium,Glass
Colour/Finish	Matt Black
Style	Contemporary
Ce Certified	Yes
Enclosure Design	Framed
Glass Thickness	8 mm
Waste Included	No

Sales Code: WRSF070

Barcode: 5056211806882

Brand: Hudson Reed

Description: Hudson Reed 700mm Framed Matrix Matt Black Wetroom Screen

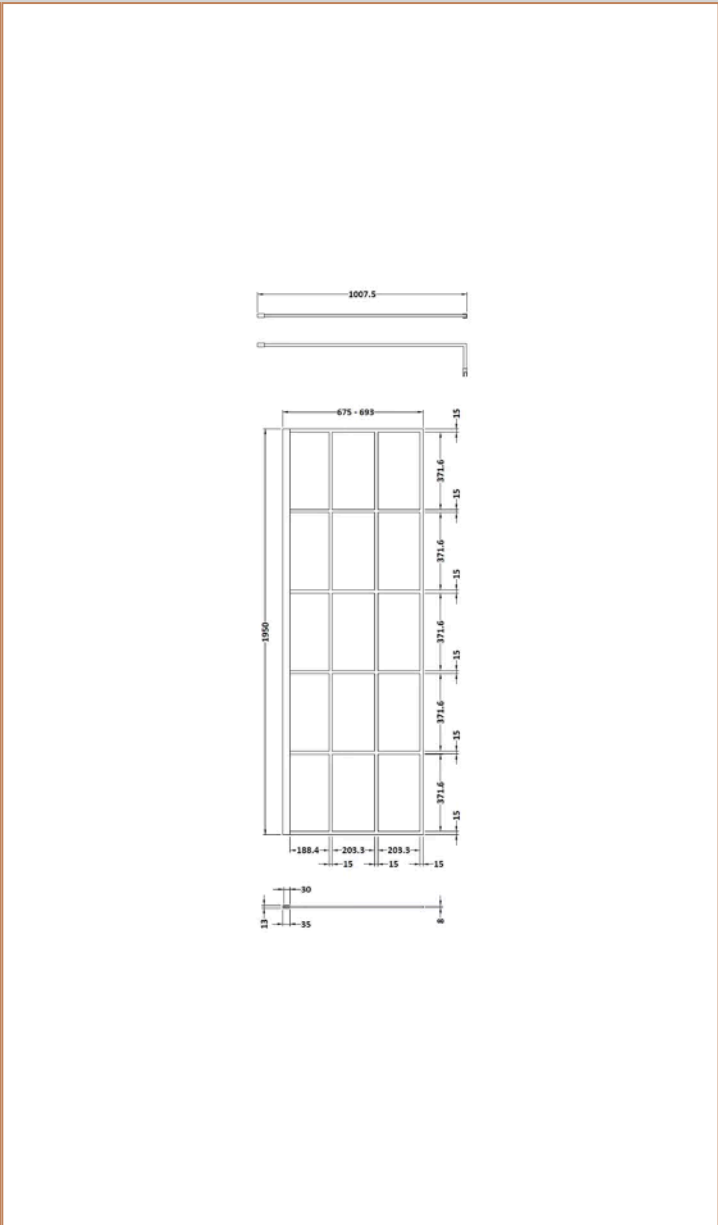
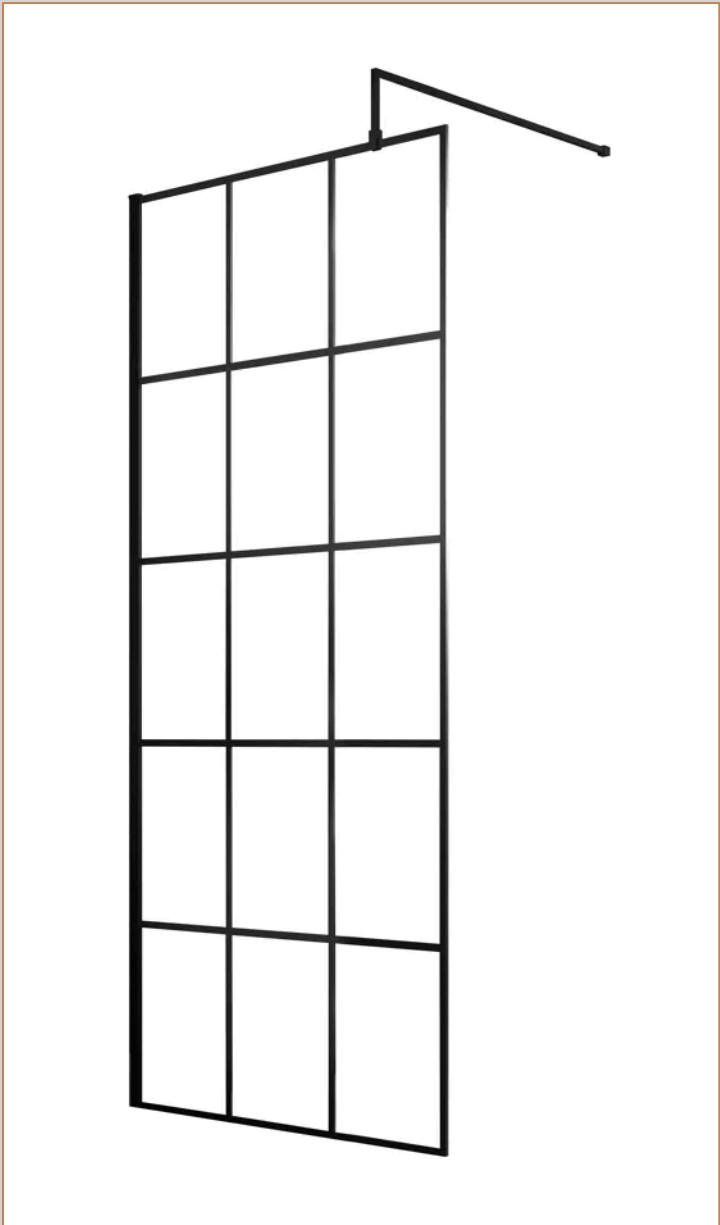

Product Dimensions

Product	1950 x 700 x 14mm (H x W x D)
Packaged	60 x 750 x 2070mm (H x W x D)
Nett Weight	31.1 kg
Packaged Weight	31.1 kg

Product Details

Country of Origin	China
Product Material	Aluminium
Colour/Finish	Matt Black
Style	Contemporary
Fixings Included	Yes
Easy Clean	Yes
Adjustment Max	693
Adjustment Min	675
Ce Certified	Yes
Declaration Of Performance	Yes
Easy Fit	No
Enclosure Design	Framed
Frame Finish	Matt Black
Glass Thickness	8 mm
Handles Included	No
Support Bar Included	Yes
Ukca Certified	Yes

Sales Code: WRSF12

Barcode: 5056211806943

Brand: Hudson Reed

Description: Hudson Reed 1200mm Matt Black Matrix Framed Wetroom Screen

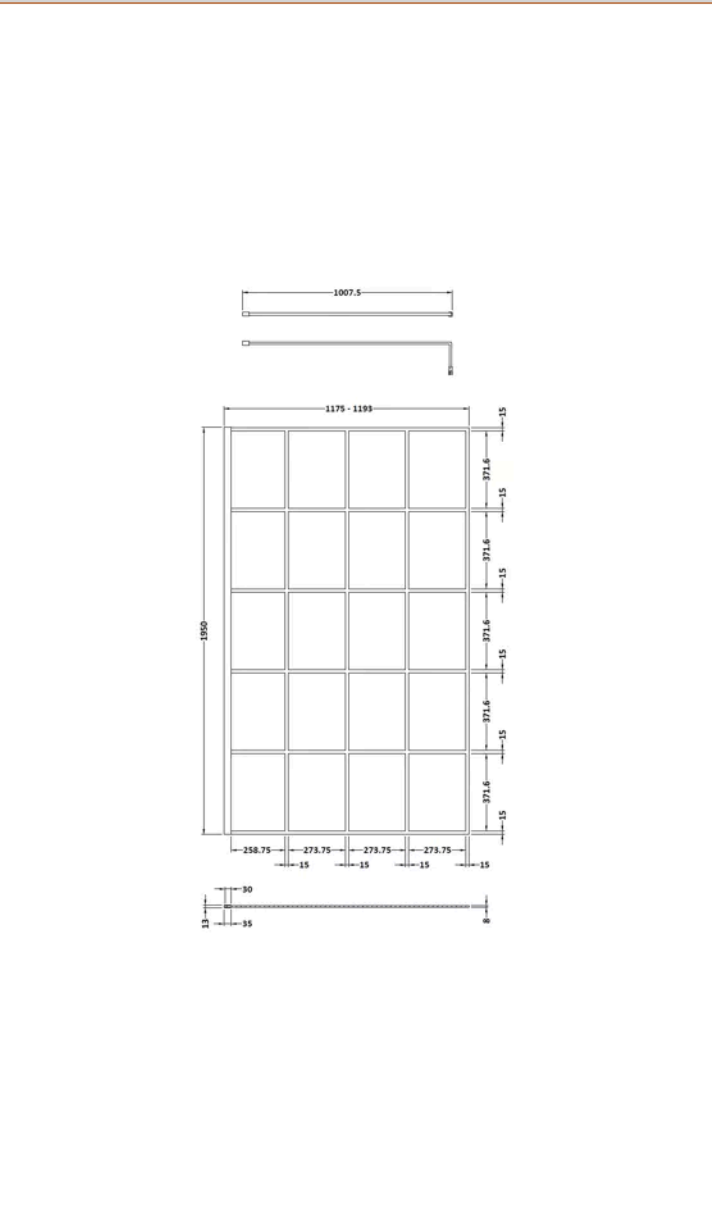
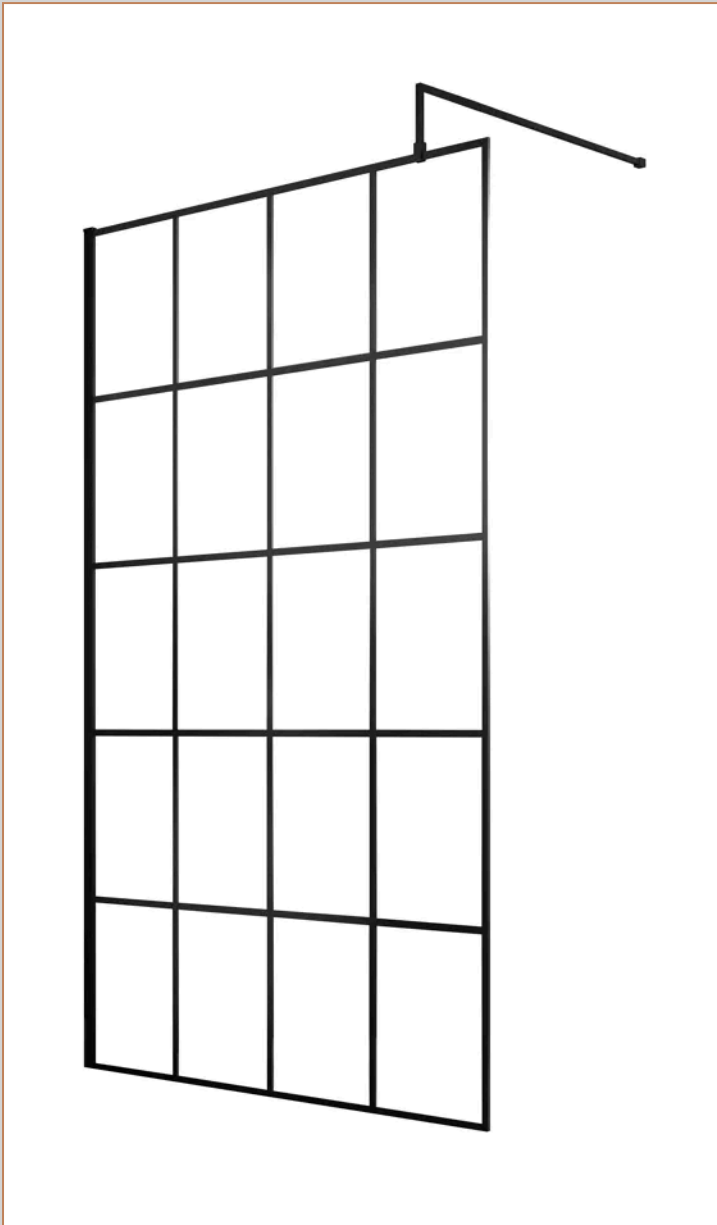

Product Dimensions

Product	1950 x 1200 x 14mm (H x W x D)
Packaged	60 x 1250 x 2070mm (H x W x D)
Nett Weight	53.2 kg
Packaged Weight	53.2 kg

Product Details

Country of Origin	China
Product Material	Aluminium
Colour/Finish	Matt Black
Style	Contemporary
Fixings Included	Yes
Easy Clean	Yes
Adjustment Max	1193
Adjustment Min	1175
Ce Certified	Yes
Declaration Of Performance	Yes
Easy Fit	No
Enclosure Design	Framed
Frame Finish	Matt Black
Glass Thickness	8 mm
Handles Included	No
Support Bar Included	Yes
Ukca Certified	Yes

Sales Code: NTP061

Barcode: 5055369006373

Brand: nuie

Description: 1700 x 700mm Rectangular Slimline Shower Tray

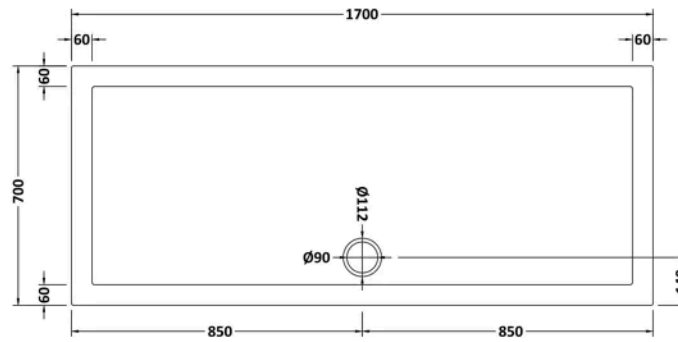

Product Dimensions

Product	40 x 700 x 1700mm (H x W x L)
Packaged	80 x 740 x 1740mm (H x W x D)
Nett Weight	37.8 kg
Packaged Weight	38.1 kg

Product Details

Country of Origin	United Kingdom
Product Material	Acrylic Capped Abs Caco3 And Pu
Colour/Finish	White
Style	Contemporary
Fixings Included	No
Ce Certified	Yes
Leg Set Included	No
Legs Included	No
Raised Edge	Yes
Slip Resistant	No
Waste Included	No
Waste Size Required	90mm

Sales Code: ENZW038

Barcode: 5056678428504

Brand: nuie

Description: nuie 800mm Framed Walk-In Wetroom Screen Set With Tray



Technical Drawing Not Available

Product Dimensions

Product	1950 x 800 x 14mm (H x W x D)
Nett Weight	124.2 kg
Packaged Weight	124.2 kg

Product Details

Country of Origin	China
Product Material	Acrylic Capped Abs Caco3 And Pu,Aluminium,Glass
Colour/Finish	Matt Black
Style	Contemporary
Ce Certified	Yes
Enclosure Design	Framed
Glass Thickness	8 mm
Waste Included	No

Sales Code: WRSF080

Barcode: 5056211806905

Brand: Hudson Reed

Description: Hudson Reed 800mm Framed Matrix Matt Black Wetroom Screen

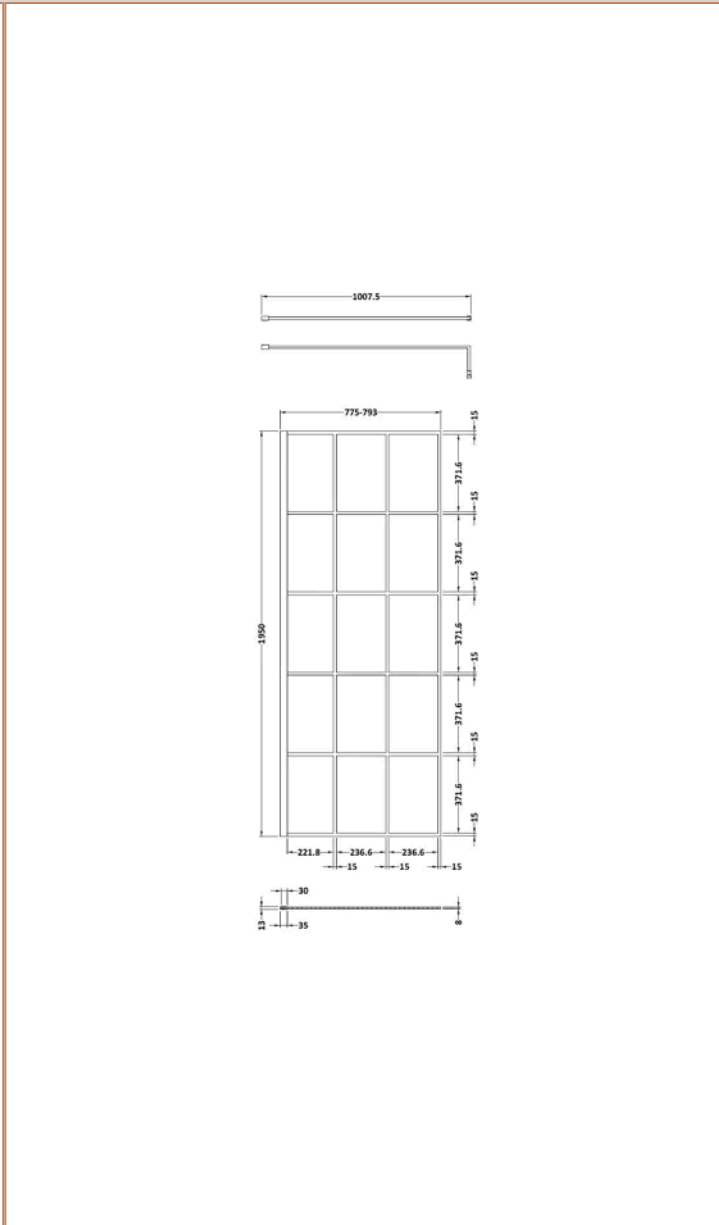
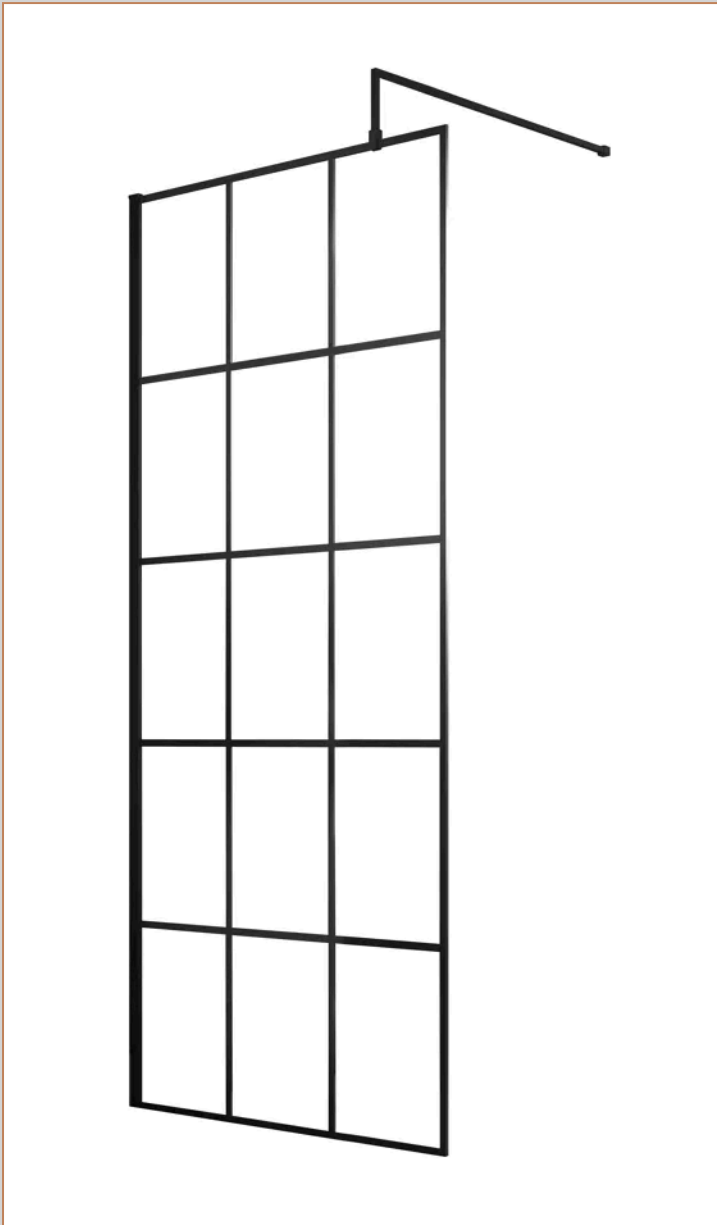

Product Dimensions

Product	1950 x 800 x 14mm (H x W x D)
Packaged	60 x 850 x 2070mm (H x W x D)
Nett Weight	35.9 kg
Packaged Weight	35.9 kg

Product Details

Country of Origin	China
Product Material	Aluminium
Colour/Finish	Matt Black
Style	Contemporary
Fixings Included	Yes
Easy Clean	Yes
Adjustment Max	793
Adjustment Min	775
Ce Certified	Yes
Declaration Of Performance	Yes
Easy Fit	No
Enclosure Design	Framed
Frame Finish	Matt Black
Glass Thickness	8 mm
Handles Included	No
Support Bar Included	Yes
Ukca Certified	Yes

Sales Code: WRSF12

Barcode: 5056211806943

Brand: Hudson Reed

Description: Hudson Reed 1200mm Matt Black Matrix Framed Wetroom Screen

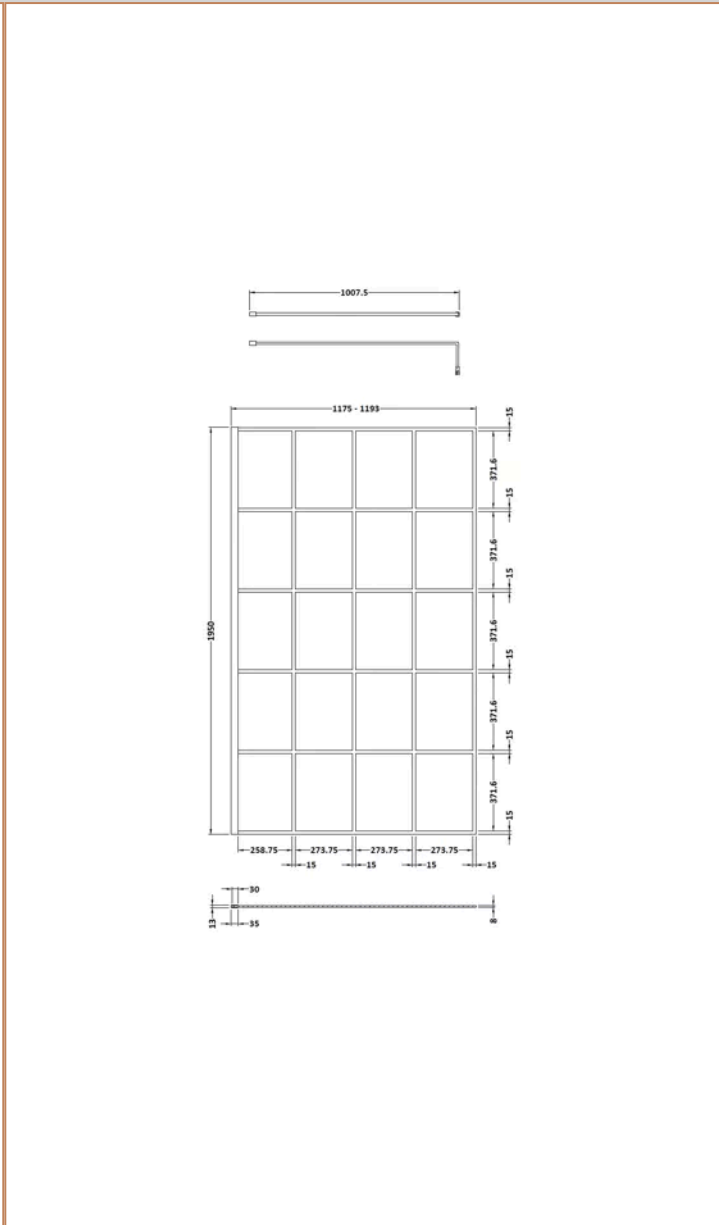
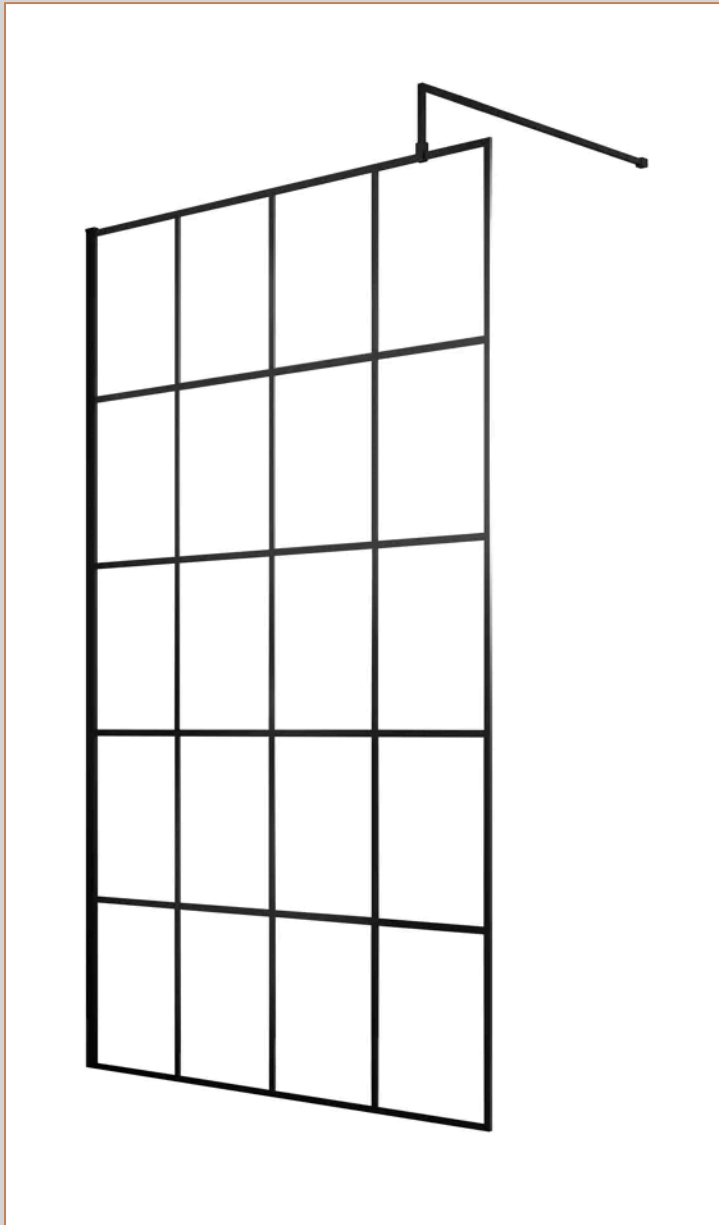

Product Dimensions

Product	1950 x 1200 x 14mm (H x W x D)
Packaged	60 x 1250 x 2070mm (H x W x D)
Nett Weight	53.2 kg
Packaged Weight	53.2 kg

Product Details

Country of Origin	China
Product Material	Aluminium
Colour/Finish	Matt Black
Style	Contemporary
Fixings Included	Yes
Easy Clean	Yes
Adjustment Max	1193
Adjustment Min	1175
Ce Certified	Yes
Declaration Of Performance	Yes
Easy Fit	No
Enclosure Design	Framed
Frame Finish	Matt Black
Glass Thickness	8 mm
Handles Included	No
Support Bar Included	Yes
Ukca Certified	Yes

Sales Code: NTP063

Barcode: 5055369006380

Brand: nuie

Description: 1700 x 800mm Rectangular Slimline Shower Tray

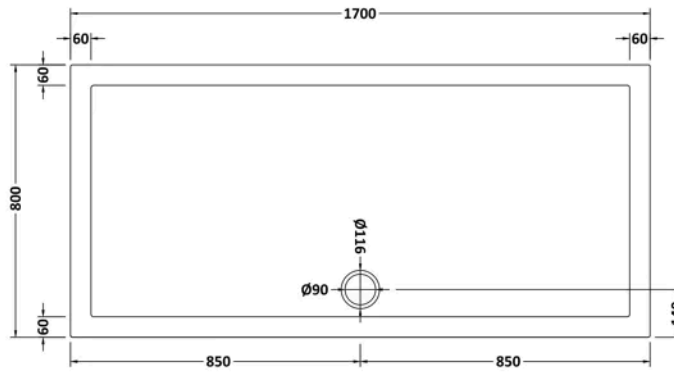

Product Dimensions

Product	40 x 800 x 1700mm (H x W x L)
Packaged	80 x 840 x 1740mm (H x W x D)
Nett Weight	43.2 kg
Packaged Weight	43.5 kg

Product Details

Country of Origin	United Kingdom
Product Material	Acrylic Capped Abs Caco3 And Pu
Colour/Finish	White
Style	Contemporary
Fixings Included	No
Ce Certified	Yes
Leg Set Included	No
Legs Included	No
Raised Edge	Yes
Slip Resistant	No
Waste Included	No
Waste Size Required	90mm

Sales Code: ENZW042

Barcode: 5056678428467

Brand: nuie

Description: nuie 900mm Framed Walk-In Wetroom Screen Set With Tray



Technical Drawing Not Available

Product Dimensions

Product	1950 x 900 x 14mm (H x W x D)
Nett Weight	135.1 kg
Packaged Weight	135.1 kg

Product Details

Country of Origin	China
Product Material	Acrylic Capped Abs Caco3 And Pu,Aluminium,Glass
Colour/Finish	Matt Black
Style	Contemporary
Ce Certified	Yes
Enclosure Design	Framed
Glass Thickness	8 mm
Waste Included	No

Sales Code: WRSF090

Barcode: 5056211806912

Brand: Hudson Reed

Description: Hudson Reed 900mm Matt Black Matrix Framed Wetroom Screen

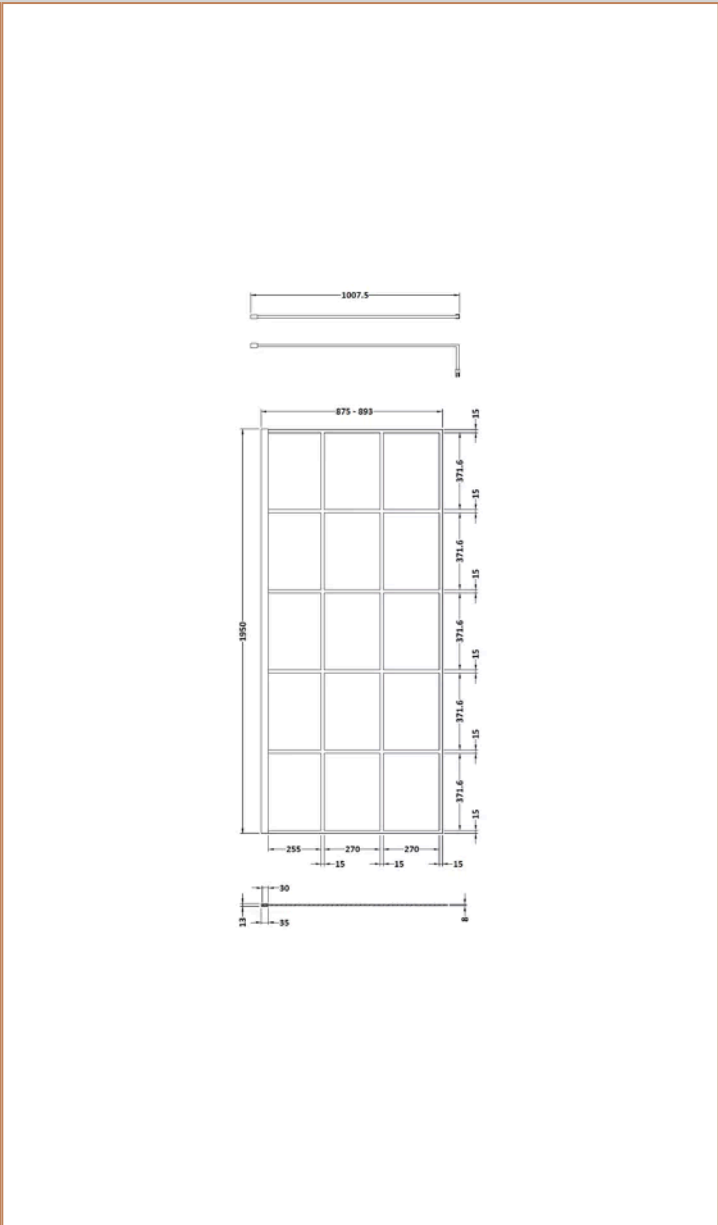
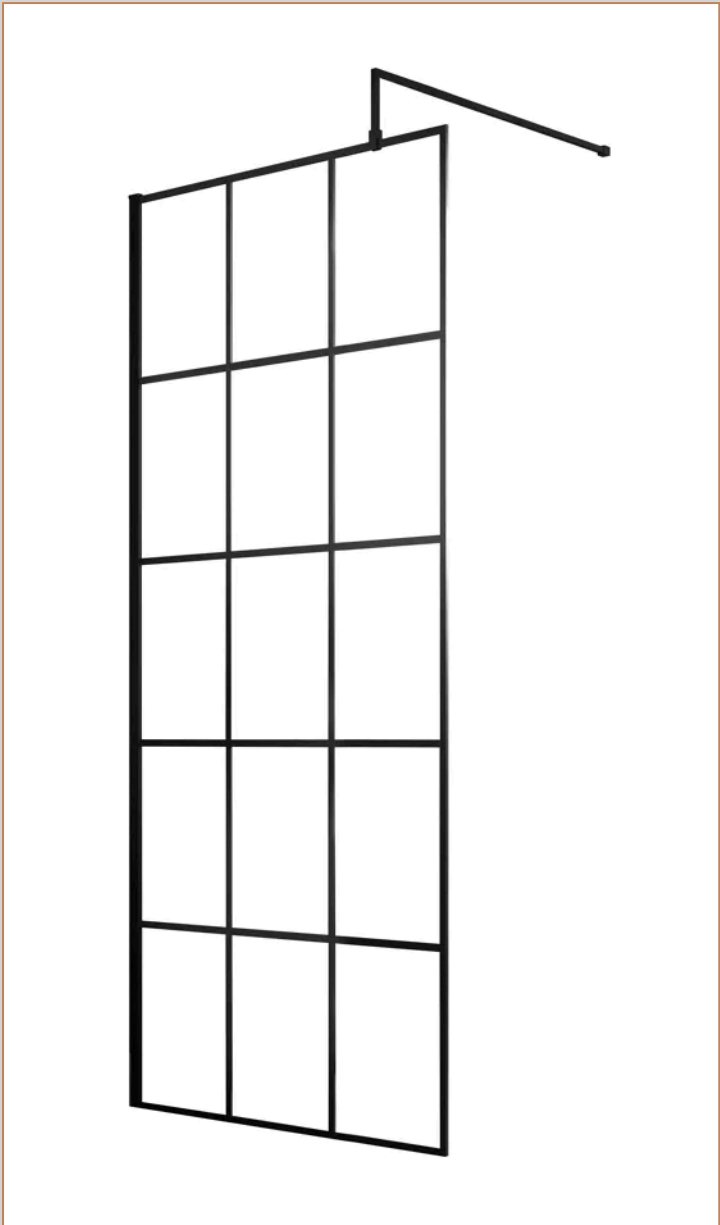

Product Dimensions

Product	1950 x 900 x 14mm (H x W x D)
Packaged	60 x 950 x 2070mm (H x W x D)
Nett Weight	40.3 kg
Packaged Weight	40.3 kg

Product Details

Country of Origin	China
Product Material	Aluminium
Colour/Finish	Matt Black
Style	Contemporary
Fixings Included	Yes
Easy Clean	Yes
Adjustment Max	893
Adjustment Min	875
Ce Certified	Yes
Declaration Of Performance	Yes
Easy Fit	No
Enclosure Design	Framed
Frame Finish	Matt Black
Glass Thickness	8 mm
Handles Included	No
Support Bar Included	Yes
Ukca Certified	Yes

Sales Code: WRSF12

Barcode: 5056211806943

Brand: Hudson Reed

Description: Hudson Reed 1200mm Matt Black Matrix Framed Wetroom Screen

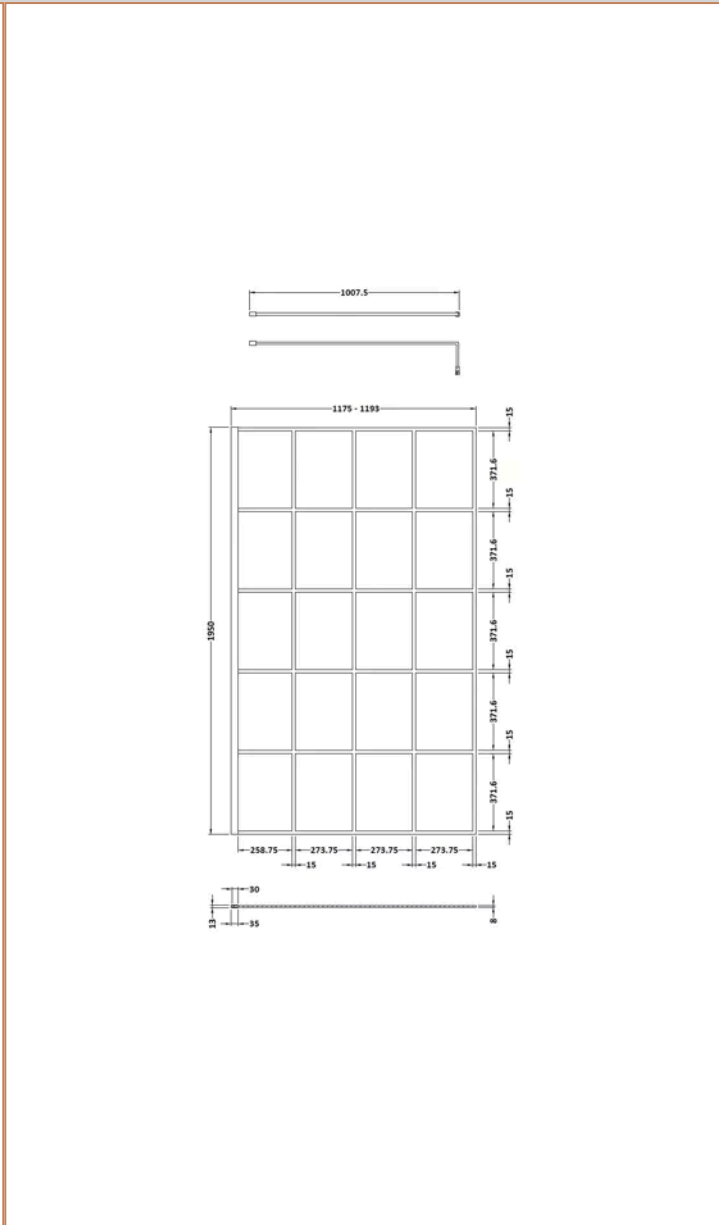
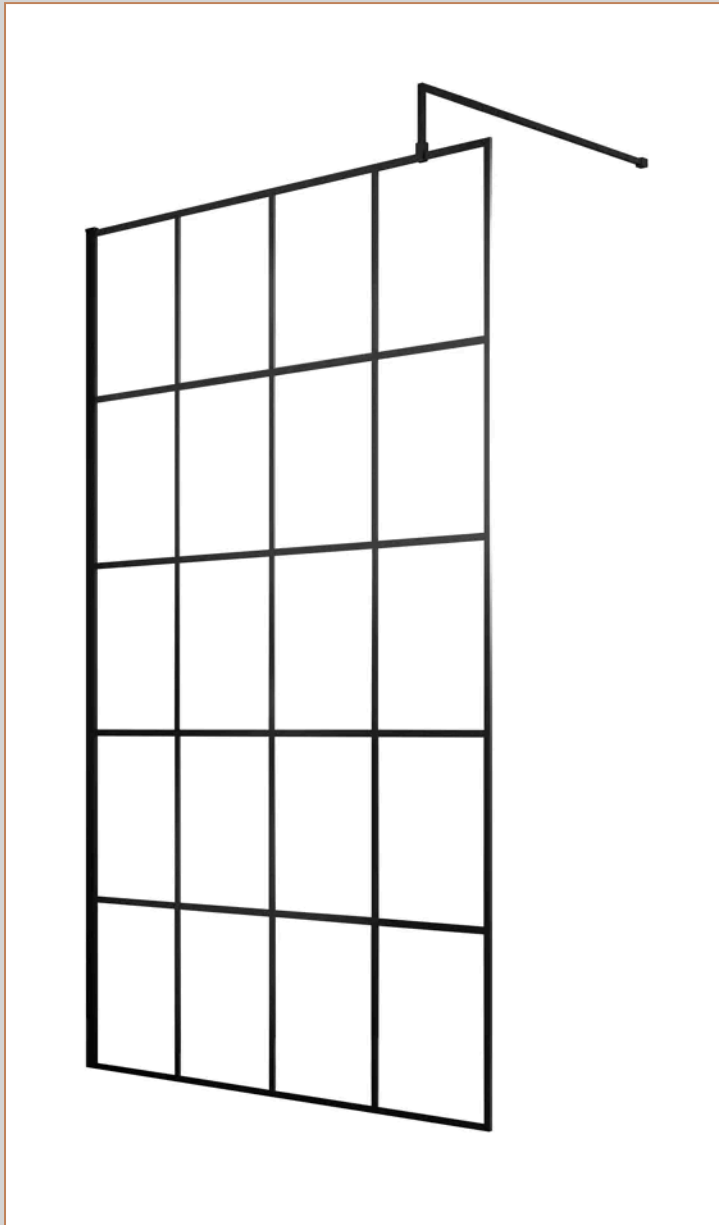

Product Dimensions

Product	1950 x 1200 x 14mm (H x W x D)
Packaged	60 x 1250 x 2070mm (H x W x D)
Nett Weight	53.2 kg
Packaged Weight	53.2 kg

Product Details

Country of Origin	China
Product Material	Aluminium
Colour/Finish	Matt Black
Style	Contemporary
Fixings Included	Yes
Easy Clean	Yes
Adjustment Max	1193
Adjustment Min	1175
Ce Certified	Yes
Declaration Of Performance	Yes
Easy Fit	No
Enclosure Design	Framed
Frame Finish	Matt Black
Glass Thickness	8 mm
Handles Included	No
Support Bar Included	Yes
Ukca Certified	Yes

Sales Code: NTP064

Barcode: 5055275869130

Brand: nuie

Description: 1700 x 900mm Rectangular Shower Tray

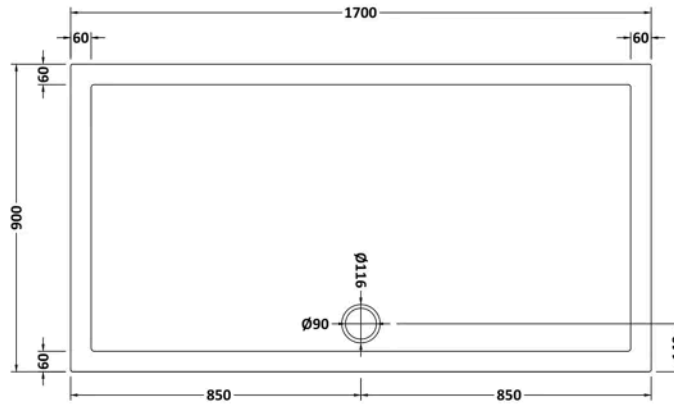

Product Dimensions

Product	40 x 900 x 1700mm (H x W x L)
Packaged	80 x 940 x 1740mm (H x W x D)
Nett Weight	50.5 kg
Packaged Weight	50.8 kg

Product Details

Country of Origin	United Kingdom
Product Material	Acrylic Capped Abs Caco3 And Pu
Colour/Finish	White
Style	Contemporary
Fixings Included	No
Ce Certified	Yes
Leg Set Included	No
Legs Included	No
Raised Edge	Yes
Slip Resistant	No
Waste Included	No
Waste Size Required	90mm