

Sales Code: ENZRE016

Barcode: 5056678409541

Brand: nuie

Description: nuie Rene 880mm Framed Satin Chrome Quadrant Shower Enclosure With Tray



Product Dimensions

Product	1850 x 880 x 880mm (H x W x D)
Nett Weight	0.01 kg
Packaged Weight	0.01 kg

Product Details

Country of Origin	China
Product Material	Aluminium
Colour/Finish	Chrome
Style	Contemporary
Ce Certified	Yes
Enclosure Design	Framed
Frame Finish	Satin Chrome
Glass Thickness	6 mm
Waste Included	Yes

Sales Code: SQU9

Barcode: 5056211815587

Brand: nuie

Description: Nuie Rene 880mm Framed Chrome Quadrant Shower Enclosure

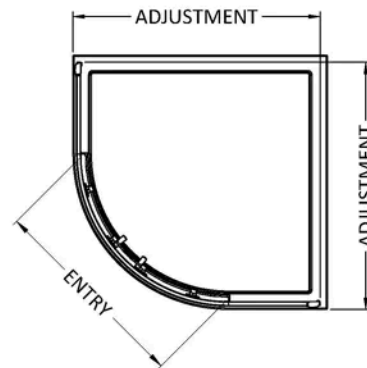
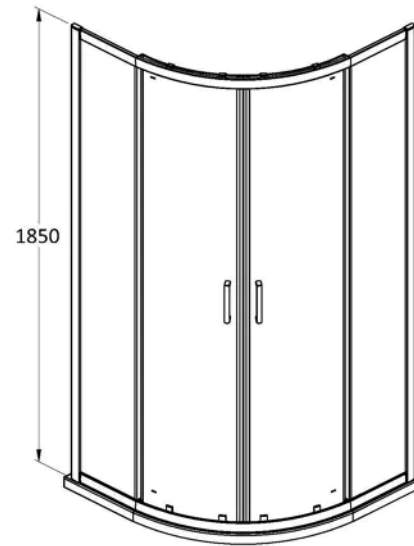

Product Dimensions

Product	1850 x 880 x 880mm (H x W x D)
Packaged	1910 x 635 x 110mm (H x W x D)
Nett Weight	44.8 kg
Packaged Weight	46.8 kg

Packaging Details

Label Size (mm)	50 x 100
-----------------	----------

Product Details

Country of Origin	China
Product Material	Abs,Aluminium
Colour/Finish	Chrome
Style	Contemporary
Handle Type	Square T Shape
Fixings Included	Yes
Easy Clean	No
Adjustment Max	895
Adjustment Min	877
Ce Certified	Yes
Declaration Of Performance	Yes
Easy Fit	Yes
Enclosure Design	Framed
Entry Width	555 mm
Frame Finish	Chrome
Glass Thickness	6 mm
Handles Included	Yes
No. Doors	2
Radius	538 mm
Support Bar Included	No
Ukca Certified	No
Wheel Type	Dual Quick Release

Sales Code: NTP106

Barcode: 5055369006205

Brand: nuie

Description: 900 x 900mm Quadrant Shower Tray

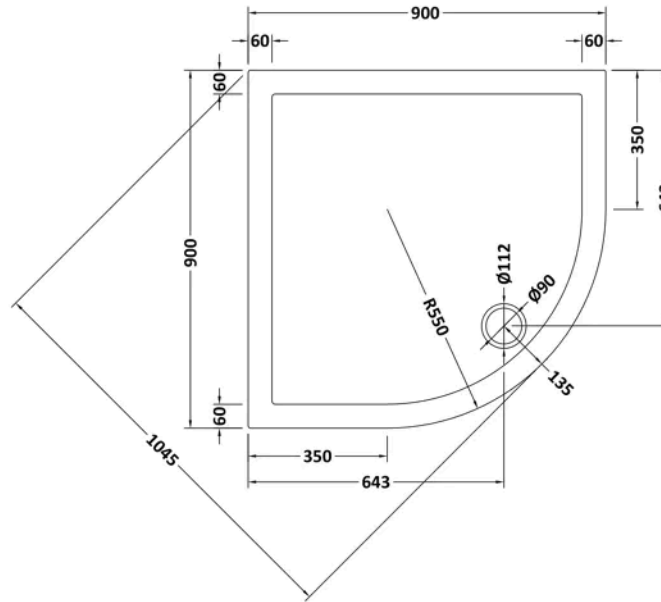

Product Dimensions

Product	40 x 900 x 900mm (H x W x L)
Packaged	80 x 940 x 940mm (H x W x D)
Nett Weight	23.3 kg
Packaged Weight	23.6 kg

Product Details

Country of Origin	United Kingdom
Product Material	Acrylic Capped Abs Caco3 And Pu
Colour/Finish	White
Style	Contemporary
Fixings Included	No
Ce Certified	Yes
Leg Set Included	No
Legs Included	No
Raised Edge	Yes
Slip Resistant	No
Waste Included	No
Waste Size Required	90mm

Sales Code: JTY375

Barcode: 5055369026869

Brand: nuie

Description: nuie Chrome Thermostatic Bar Dual Shower Valve

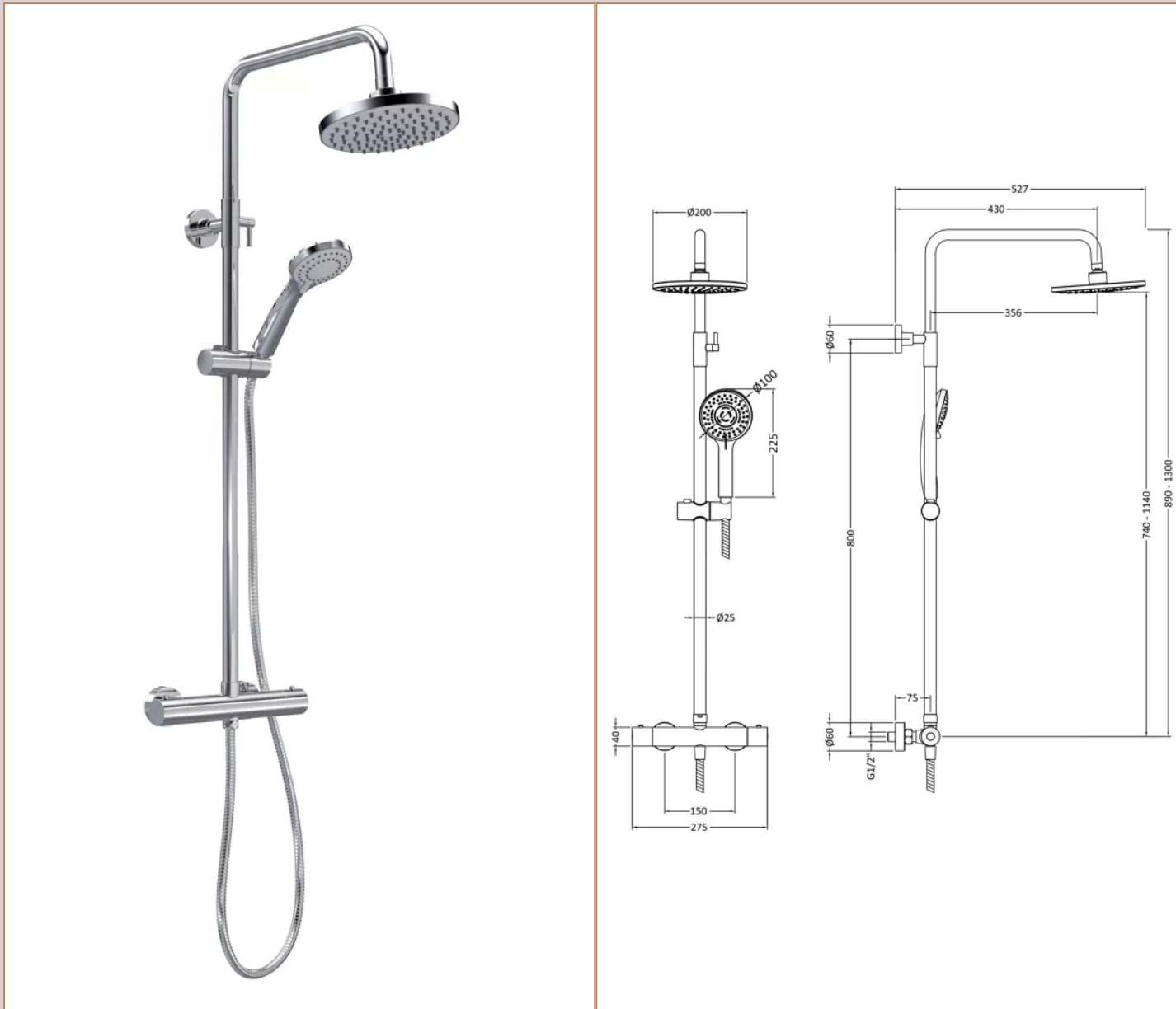

Product Dimensions

Product	1245 x 267 x 429mm (H x W x D)
Packaged	85 x 410 x 880mm (H x W x D)
Outer Box	570 x 780 x 450mm (H x W x D)
Nett Weight	3.98 kg
Packaged Weight	3.98 kg

Packaging Details

Label Size (mm)	50 x 100
Label Colour	White
Label Qty	2.0000

Product Details

Country of Origin	China
Product Material	Brass Abs
Control Type	Manual
WRAS Approved	Yes
Valve/Cartridge Type	1/4 Turn
Colour/Finish	Chrome
Mount Type	Surface/Wall
Style	Contemporary
Handle Type	Round
Easy Clean	Yes
TMV2 Approved	Yes
TMV3 Approved	No
Pipe Size	15 mm (1/2" BSP)
Pipe Centres	150
Handset Included	Yes
Head Included	Yes
Hose Included	Yes
Hose Length	1500 mm
Min Operating Pressure	1 Bar
Minimum Operation Pressure	1 Bar
No. Outlets	2.0000
Outlet Elbow Supplied	No
Tmv2 Approval Number	2503071
Valve / Cartridge Type	1/4 Turn
Wras Approval No	2307019

Sales Code: STW001

Barcode: 5055369011629

Brand: nuie

Description: 90mm Fast Flow Shower Tray Waste

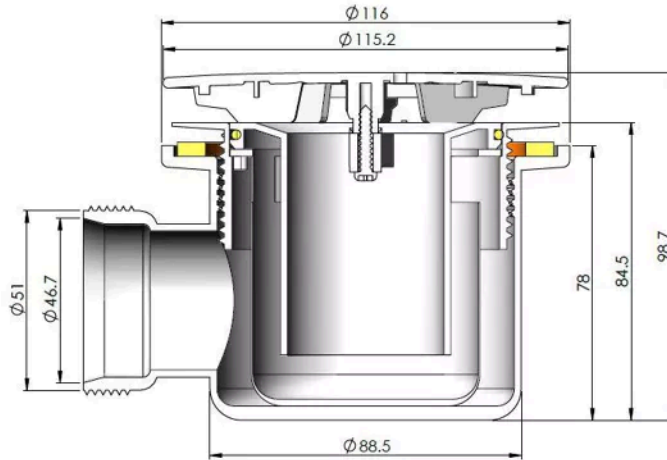

Product Dimensions

Product	99 x 116 x 116mm (H x W x D)
Packaged	100 x 135 x 170mm (H x W x D)
Nett Weight	0.31 kg
Packaged Weight	0.37 kg

Product Details

Country of Origin	United Kingdom
Product Material	Polypropylene
Waste Type	Fast Flow
Colour/Finish	Chrome
Style	Contemporary
Waste Shape	Round