

**Sales Code:** WRFBP1870

**Barcode:** 5056462688459

**Brand:** nuie

**Description:** nuie 700mm Matt Black Outer Frame Wetroom Screen

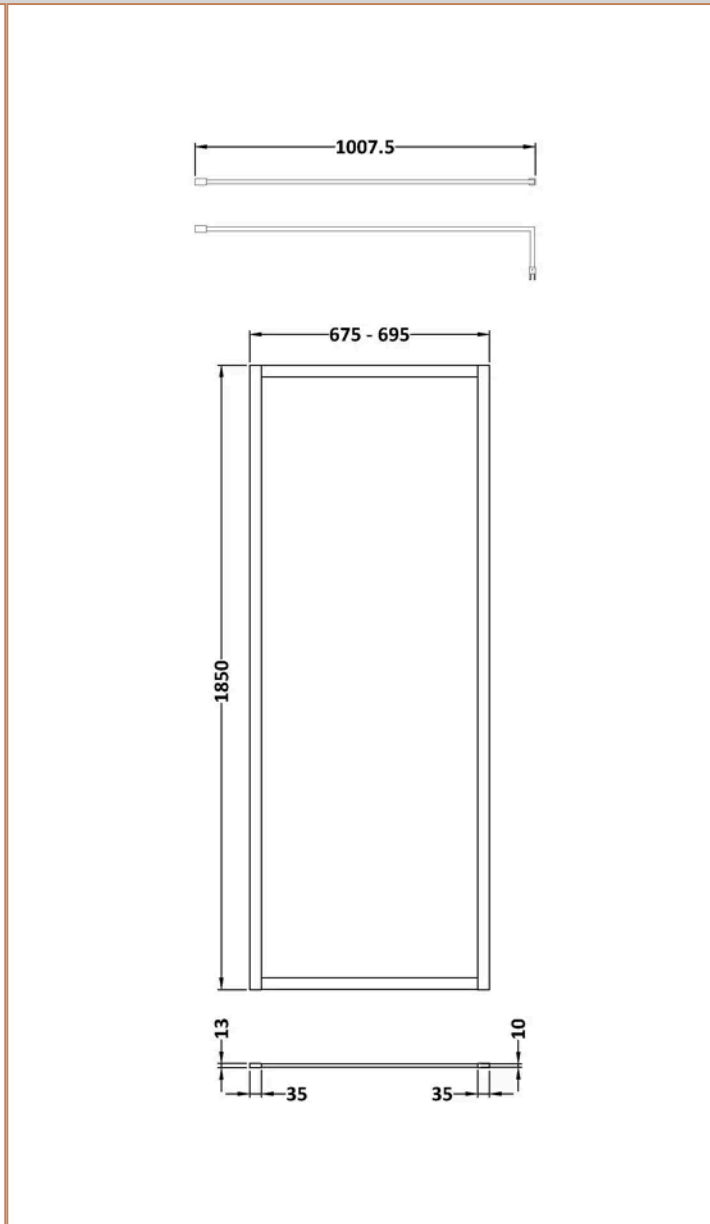
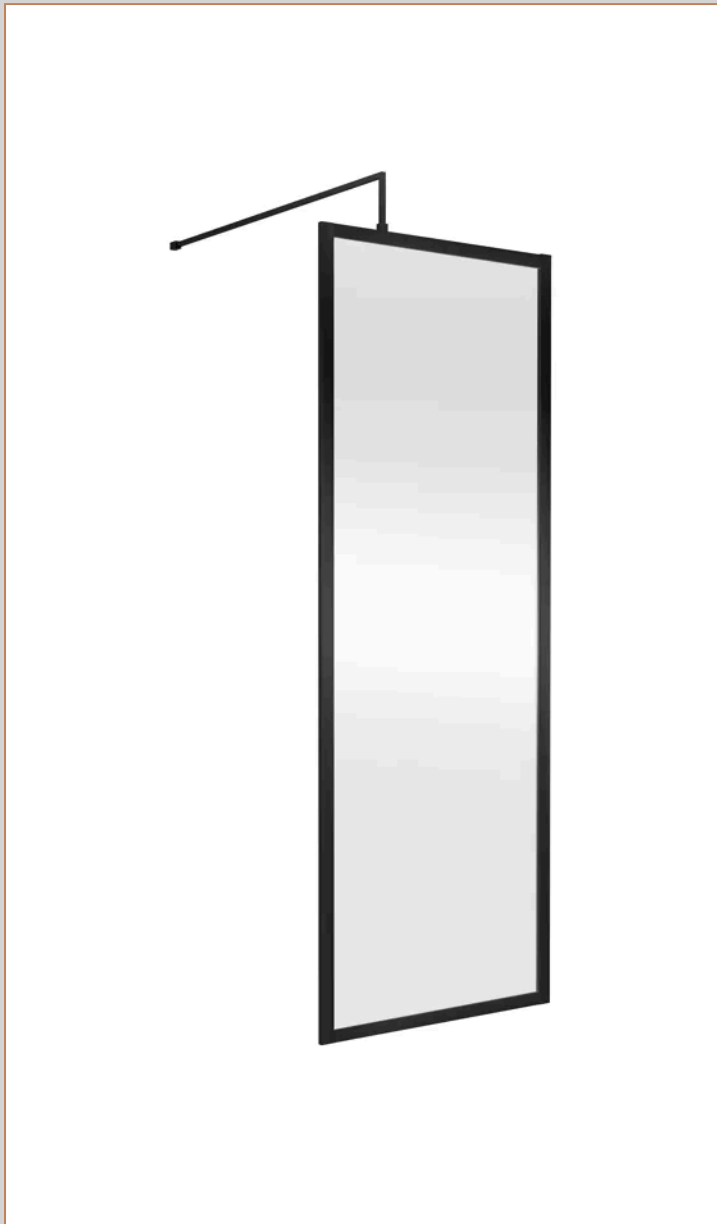

### Product Dimensions

Product	1850 x 700 x 13mm (H x W x D)
Packaged	550 x 550 x 550mm (H x W x D)
Nett Weight	31.78 kg
Packaged Weight	0 kg

### Product Details

Country of Origin	China
Product Material	Aluminium
Colour/Finish	Matt Black
Style	Contemporary
Easy Clean	No
Adjustment Max	700
Adjustment Min	680
Ce Certified	Yes
Easy Fit	No
Enclosure Design	Framed
Frame Finish	Matt Black
Glass Thickness	8 mm
Handles Included	No
Ukca Certified	Yes

**Sales Code:** FIX024

**Barcode:** 5056211847342

**Brand:** Hudson Reed

**Description:** Matt Black Wetroom Screen Support Arm

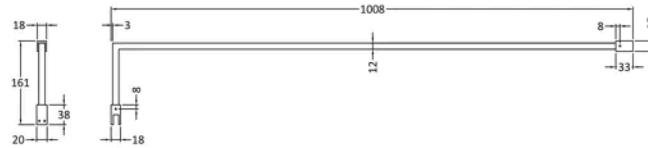

### Product Dimensions

Product	15 x 150 x 1000mm (H x W x D)
Packaged	35 x 160 x 1020mm (H x W x D)
Nett Weight	0.67 kg
Packaged Weight	0.7 kg

### Product Details

Country of Origin	China
Product Material	Stainless Steel
Colour/Finish	Matt Black
Style	Contemporary

**Sales Code:** WRSF004UF

**Barcode:** 5056462618968

**Brand:** nuie

**Description:** 1950mm Undrilled Flat Profile



**Product Dimensions**

Product	45 x 185 x 1970mm (H x W x D)
Packaged	400 x 50 x 1970mm (H x W x D)
Nett Weight	1.01 kg
Packaged Weight	1.42 kg

**Product Details**

Country of Origin	China
Product Material	Aluminium
Colour/Finish	Matt Black
Style	Contemporary

**Sales Code:** WRSF009

**Barcode:** 5056211897224

**Brand:** nuie

**Description:** Matt Black 1850mm Wetroom Wall Channel

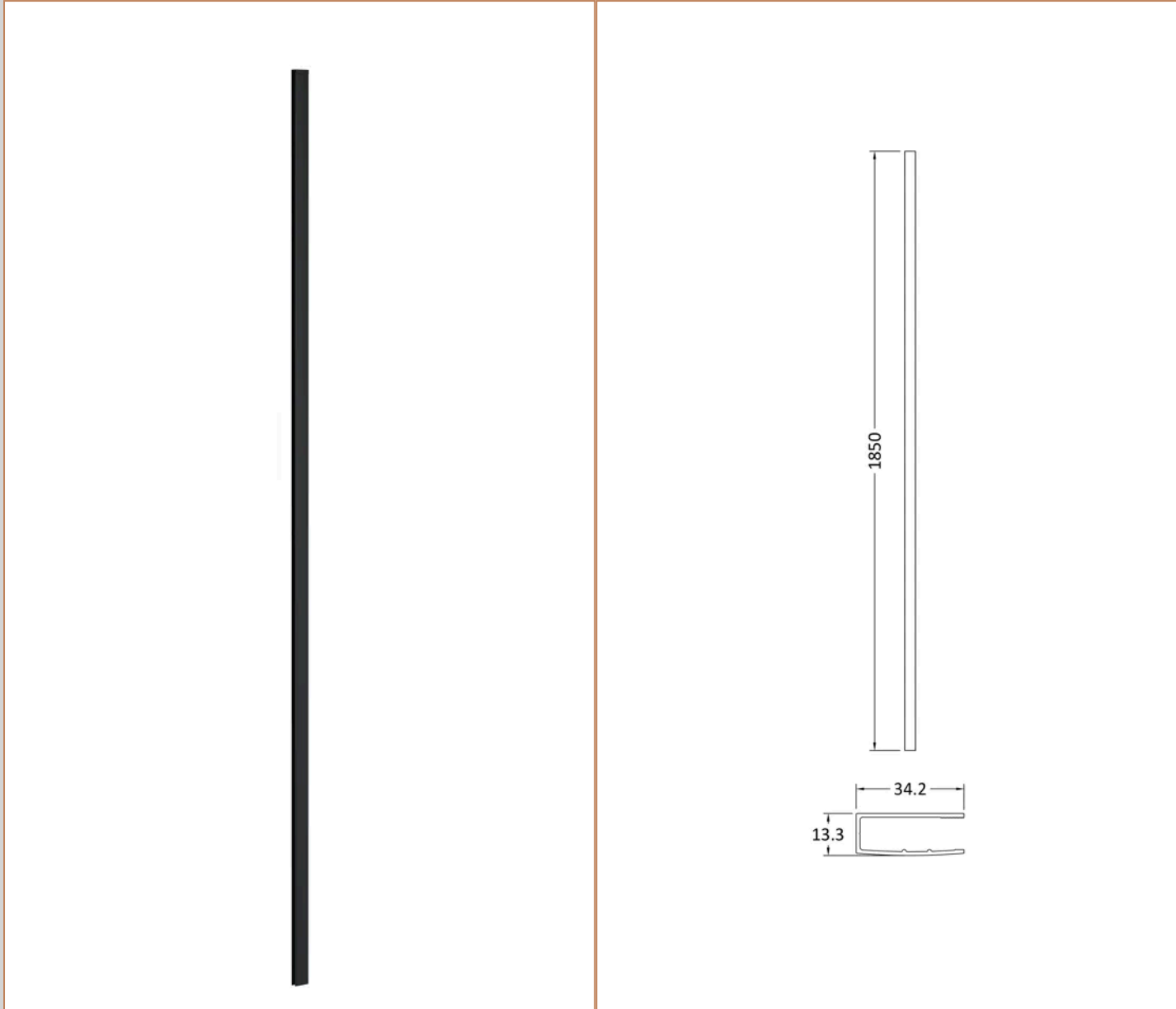

**Product Dimensions**

Product	60 x 185 x 1860mm (H x W x D)
Packaged	400 x 50 x 1860mm (H x W x D)
Nett Weight	0.6 kg
Packaged Weight	0.6 kg

**Product Details**

Product Material	Aluminium
------------------	-----------

**Sales Code:** WRFBP1876

**Barcode:** 5056462688466

**Brand:** nuie

**Description:** nuie 760mm Matt Black Outer Frame Wetroom Screen

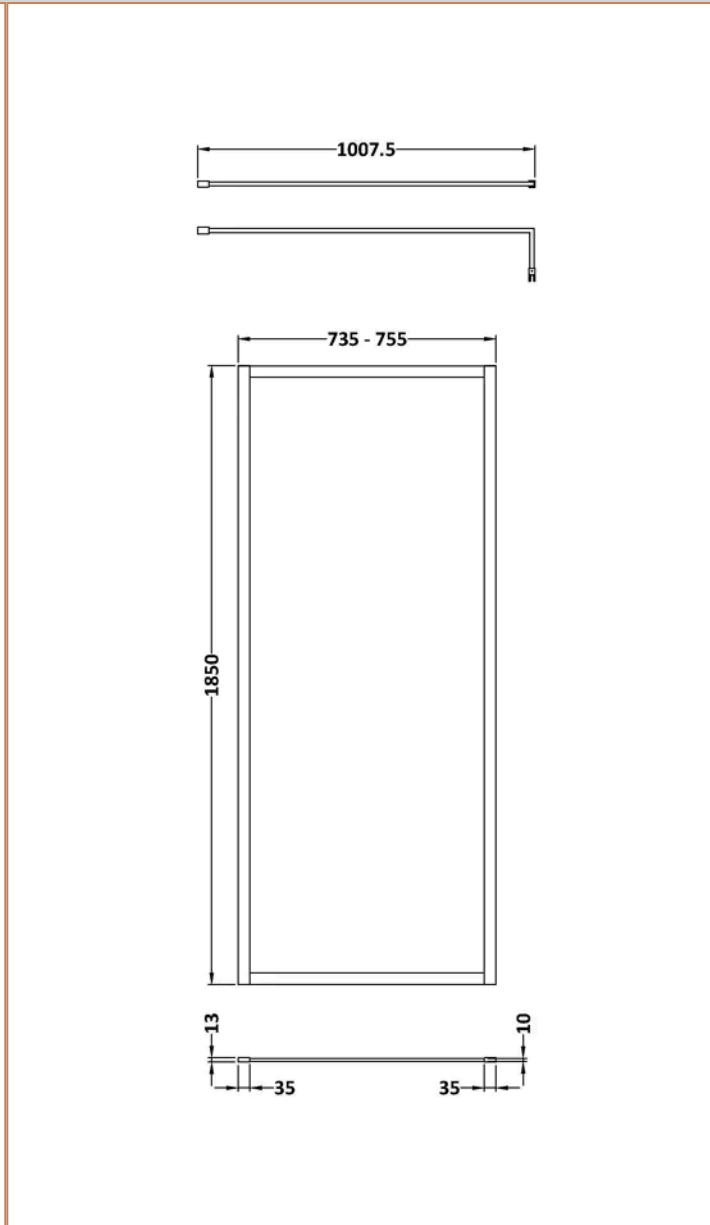
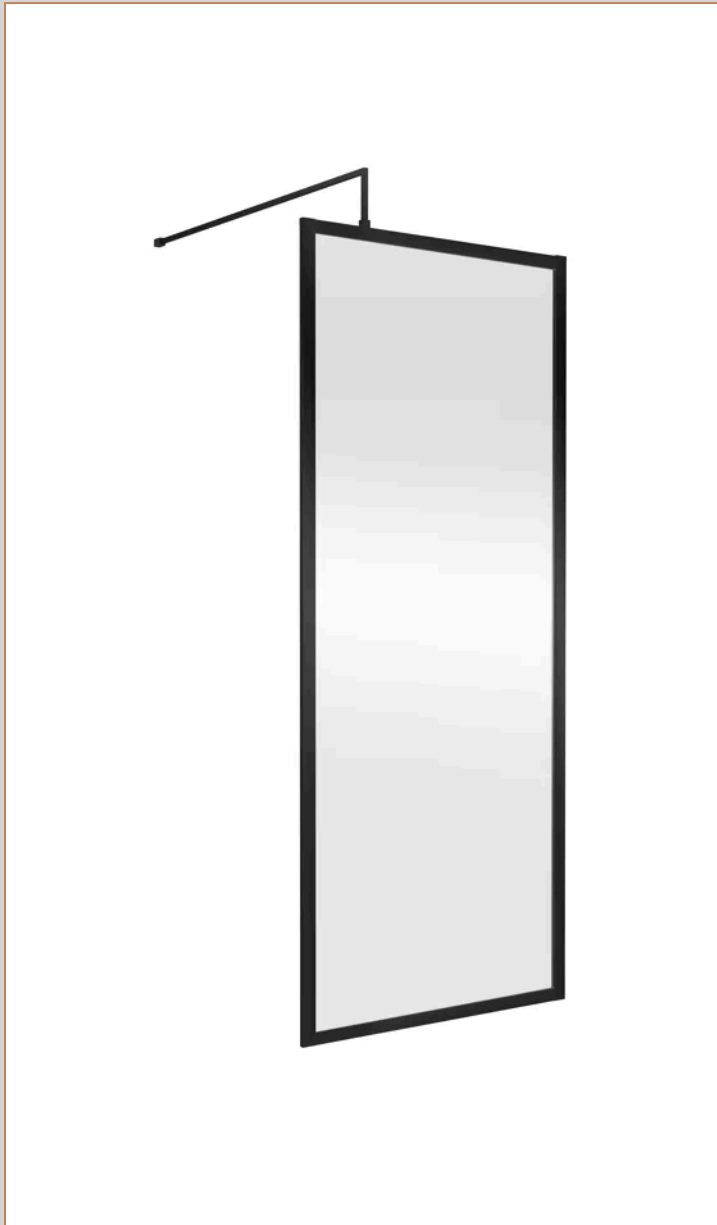

### Product Dimensions

Product	1850 x 760 x 13mm (H x W x D)
Packaged	550 x 550 x 550mm (H x W x D)
Nett Weight	34.78 kg
Packaged Weight	0 kg

### Product Details

Country of Origin	China
Product Material	Aluminium
Colour/Finish	Matt Black
Style	Contemporary
Easy Clean	No
Adjustment Max	760
Adjustment Min	740
Ce Certified	Yes
Easy Fit	No
Enclosure Design	Framed
Frame Finish	Matt Black
Glass Thickness	8 mm
Handles Included	No
Ukca Certified	Yes

**Sales Code:** FIX024

**Barcode:** 5056211847342

**Brand:** Hudson Reed

**Description:** Matt Black Wetroom Screen Support Arm

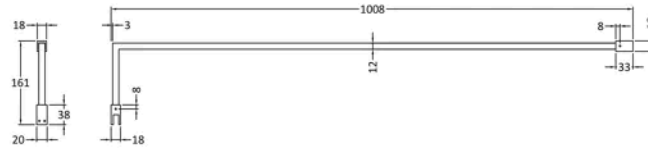

### Product Dimensions

Product	15 x 150 x 1000mm (H x W x D)
Packaged	35 x 160 x 1020mm (H x W x D)
Nett Weight	0.67 kg
Packaged Weight	0.7 kg

### Product Details

Country of Origin	China
Product Material	Stainless Steel
Colour/Finish	Matt Black
Style	Contemporary

**Sales Code:** WRSF004UF

**Barcode:** 5056462618968

**Brand:** nuie

**Description:** 1950mm Undrilled Flat Profile

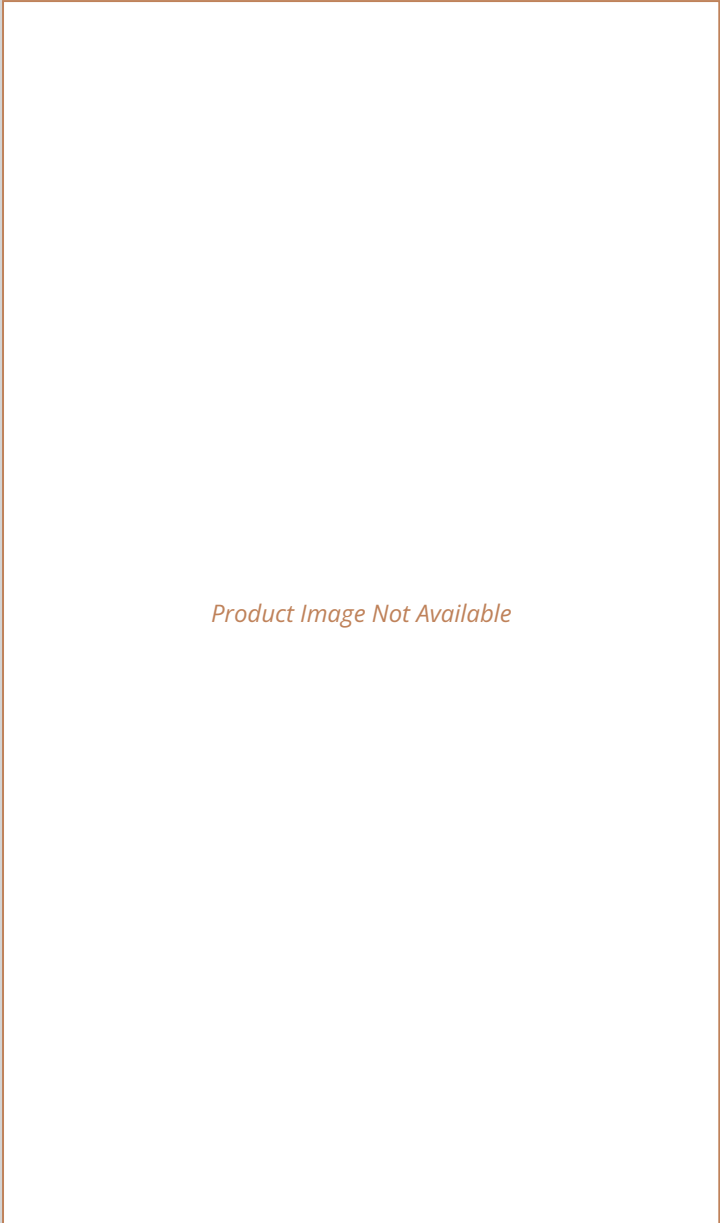

**Product Dimensions**

Product	45 x 185 x 1970mm (H x W x D)
Packaged	400 x 50 x 1970mm (H x W x D)
Nett Weight	1.01 kg
Packaged Weight	1.42 kg

**Product Details**

Country of Origin	China
Product Material	Aluminium
Colour/Finish	Matt Black
Style	Contemporary

**Sales Code:** WRSF009

**Barcode:** 5056211897224

**Brand:** nuie

**Description:** Matt Black 1850mm Wetroom Wall Channel

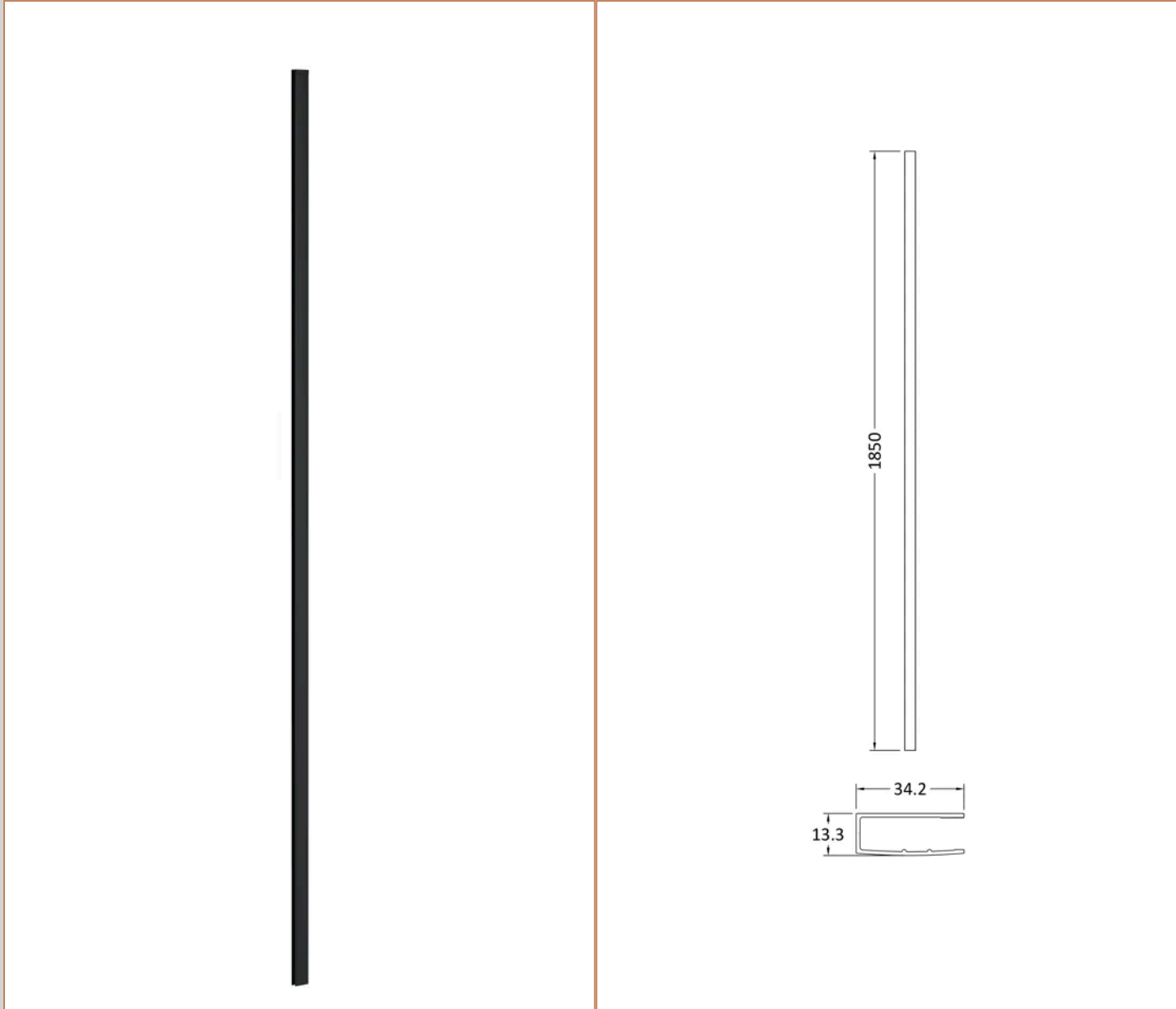

**Product Dimensions**

Product	60 x 185 x 1860mm (H x W x D)
Packaged	400 x 50 x 1860mm (H x W x D)
Nett Weight	0.6 kg
Packaged Weight	0.6 kg

**Product Details**

Product Material	Aluminium
------------------	-----------

**Sales Code:** WRFBP1880

**Barcode:** 5056462688473

**Brand:** nuie

**Description:** nuie 800mm Matt Black Outer Frame Wetroom Screen

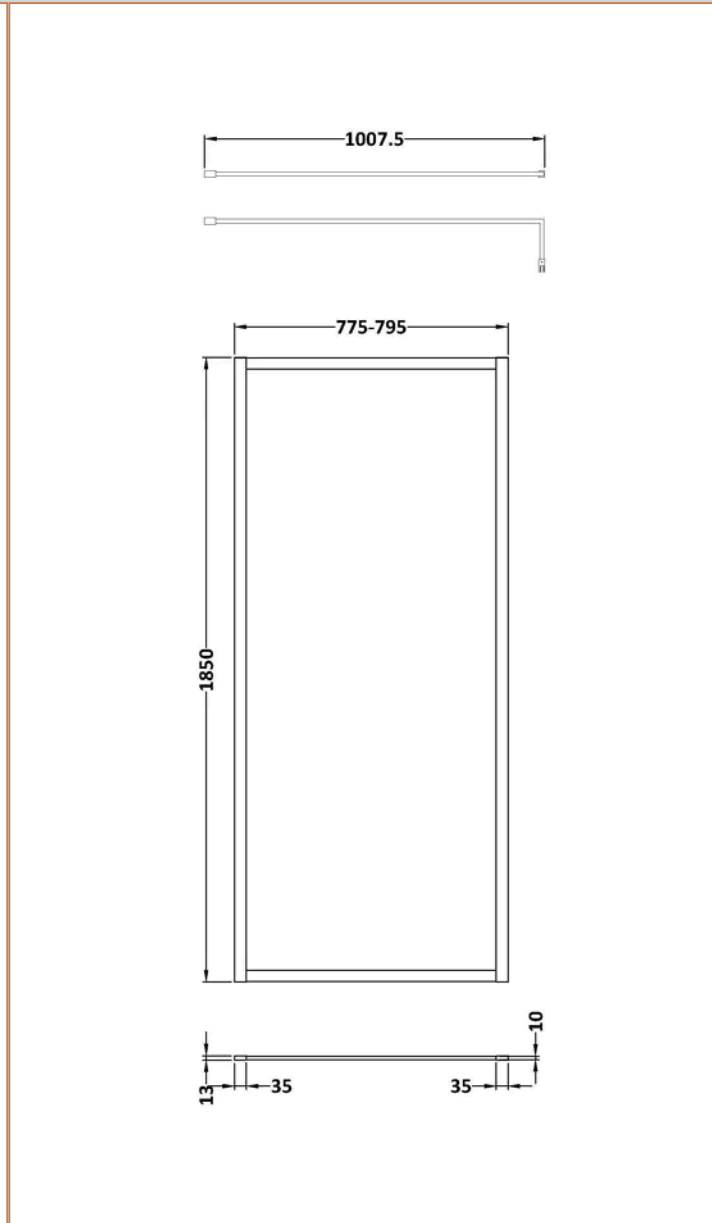
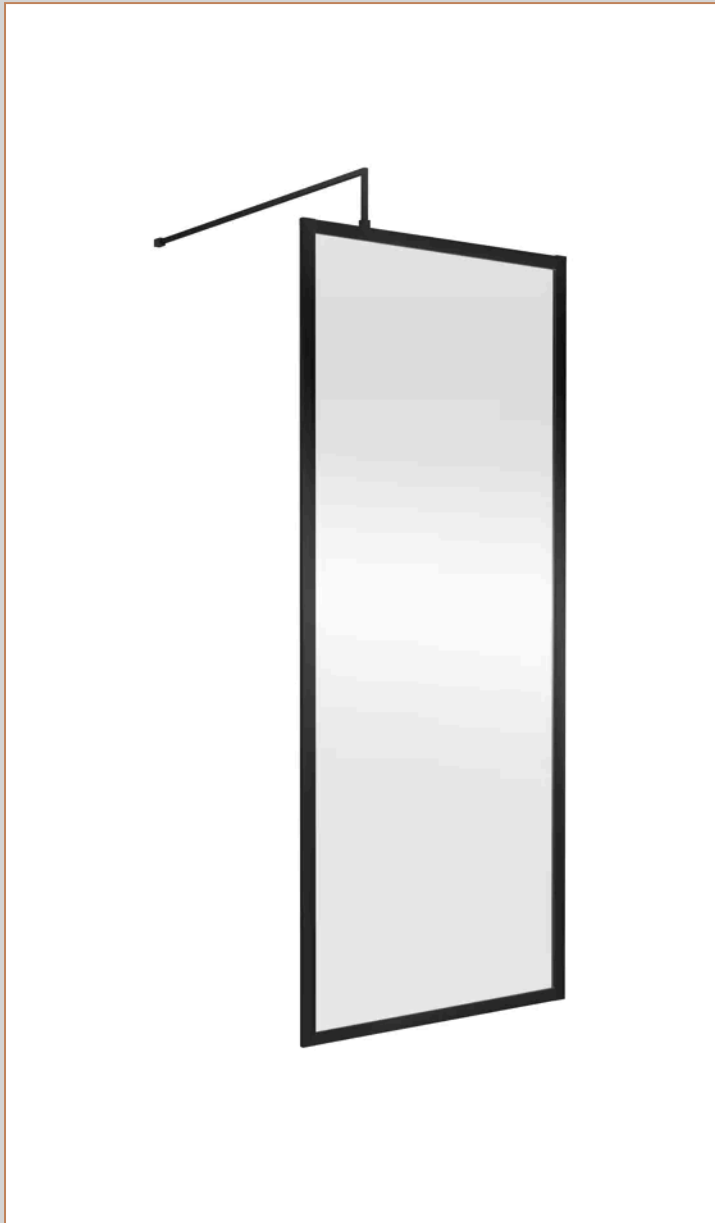

### Product Dimensions

Product	1850 x 800 x 13mm (H x W x D)
Packaged	550 x 550 x 550mm (H x W x D)
Nett Weight	36.28 kg
Packaged Weight	0 kg

### Product Details

Country of Origin	China
Product Material	Aluminium
Colour/Finish	Matt Black
Style	Contemporary
Easy Clean	No
Adjustment Max	800
Adjustment Min	780
Ce Certified	Yes
Easy Fit	No
Enclosure Design	Framed
Frame Finish	Matt Black
Glass Thickness	8 mm
Handles Included	No
Ukca Certified	Yes

**Sales Code:** FIX024

**Barcode:** 5056211847342

**Brand:** Hudson Reed

**Description:** Matt Black Wetroom Screen Support Arm

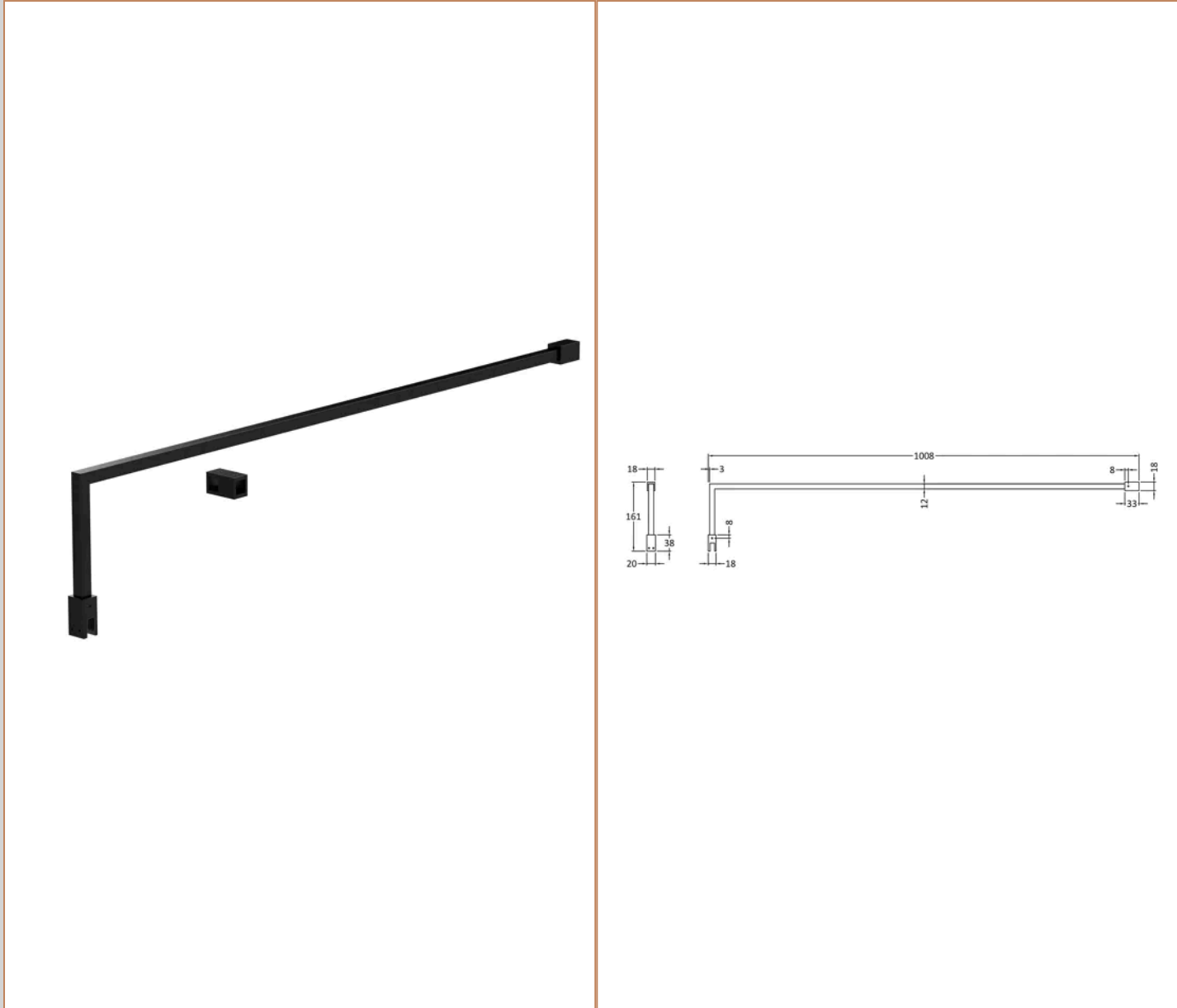

**Product Dimensions**

Product	15 x 150 x 1000mm (H x W x D)
Packaged	35 x 160 x 1020mm (H x W x D)
Nett Weight	0.67 kg
Packaged Weight	0.7 kg

**Product Details**

Country of Origin	China
Product Material	Stainless Steel
Colour/Finish	Matt Black
Style	Contemporary

**Sales Code:** WRSF004UF

**Barcode:** 5056462618968

**Brand:** nuie

**Description:** 1950mm Undrilled Flat Profile

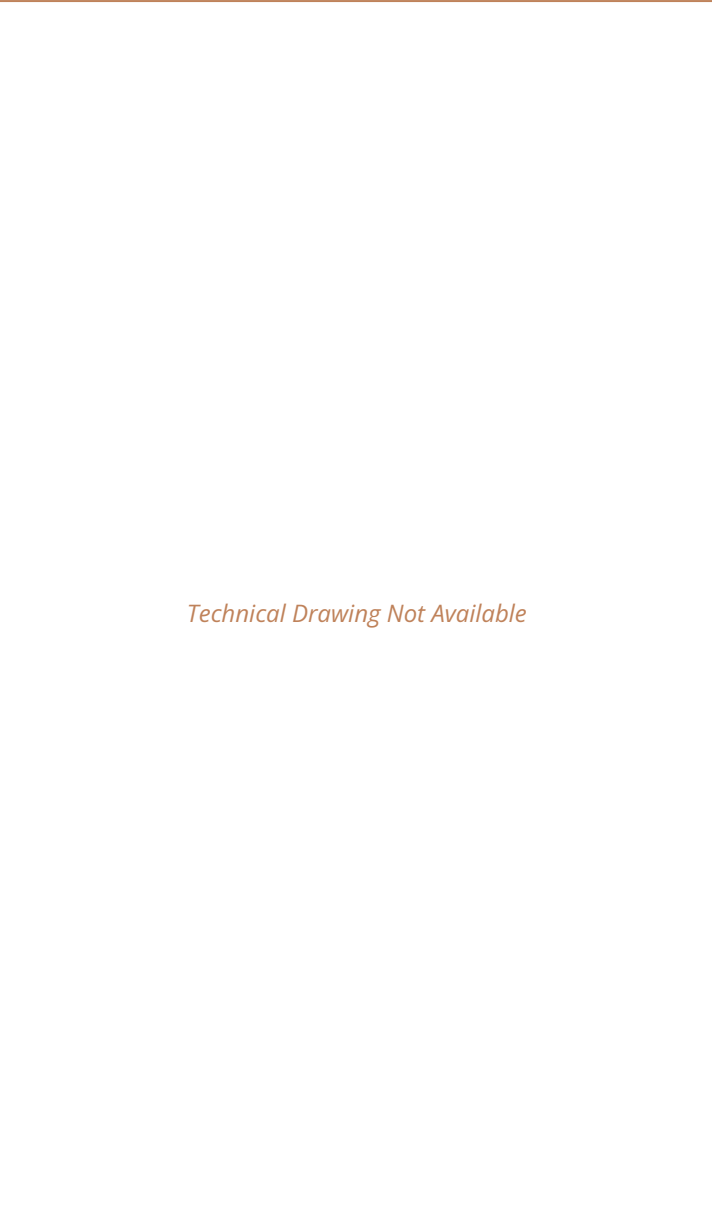
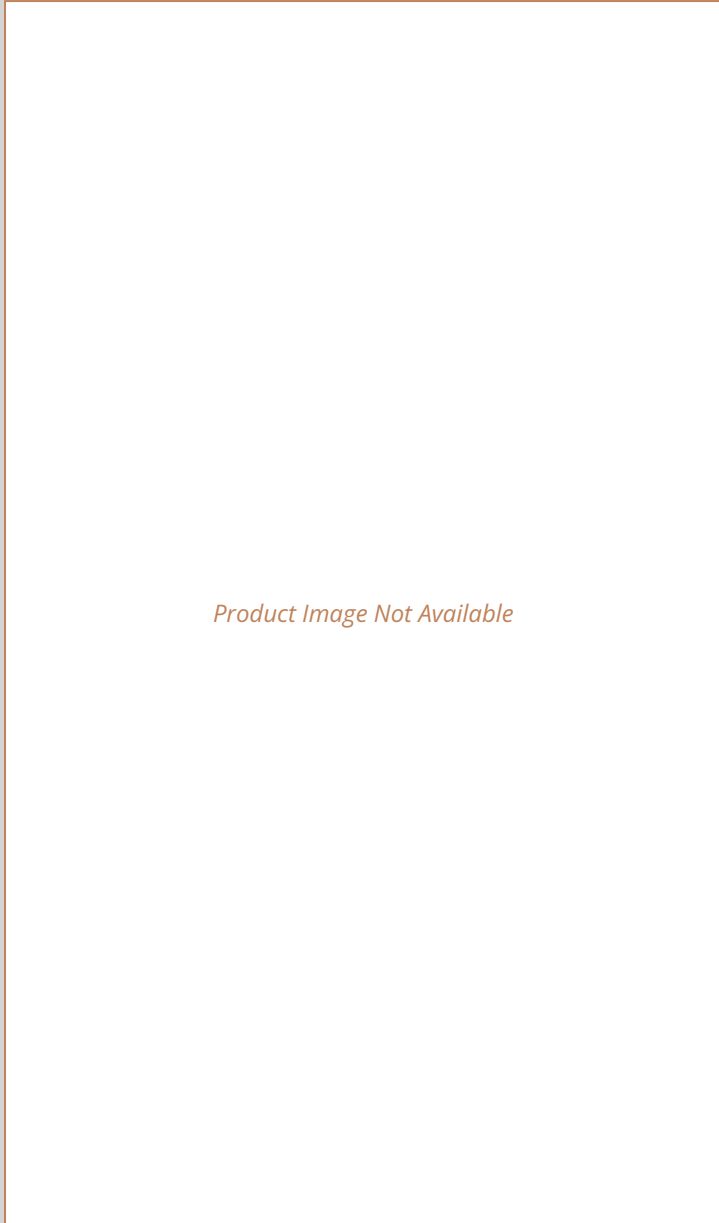

**Product Dimensions**

Product	45 x 185 x 1970mm (H x W x D)
Packaged	400 x 50 x 1970mm (H x W x D)
Nett Weight	1.01 kg
Packaged Weight	1.42 kg

**Product Details**

Country of Origin	China
Product Material	Aluminium
Colour/Finish	Matt Black
Style	Contemporary

**Sales Code:** WRSF009

**Barcode:** 5056211897224

**Brand:** nuie

**Description:** Matt Black 1850mm Wetroom Wall Channel

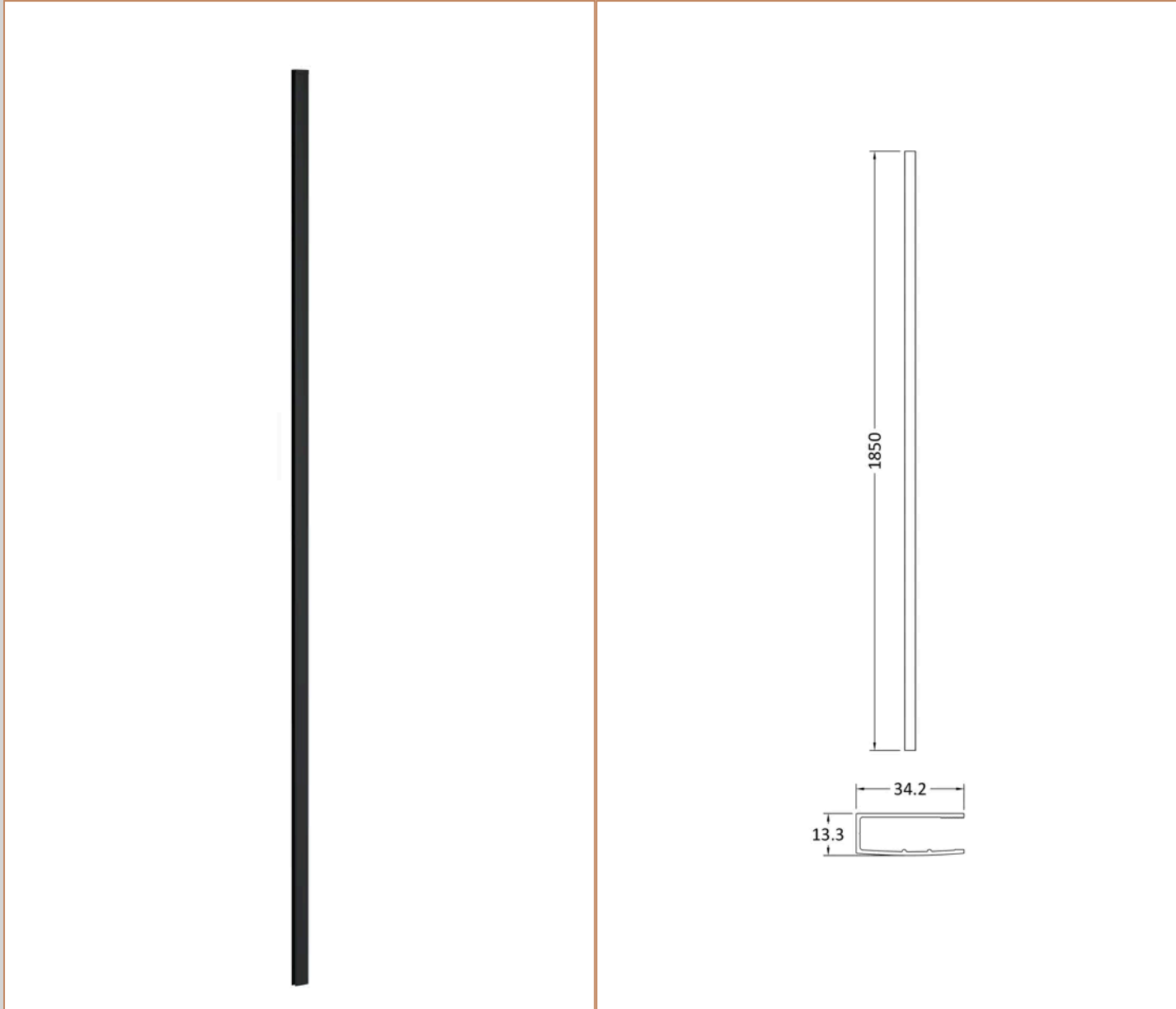

**Product Dimensions**

Product	60 x 185 x 1860mm (H x W x D)
Packaged	400 x 50 x 1860mm (H x W x D)
Nett Weight	0.6 kg
Packaged Weight	0.6 kg

**Product Details**

Product Material	Aluminium
------------------	-----------

**Sales Code:** WRFBP1890

**Barcode:** 5056462688480

**Brand:** nuie

**Description:** nuie 900mm Matt Black Outer Frame Wetroom Screen

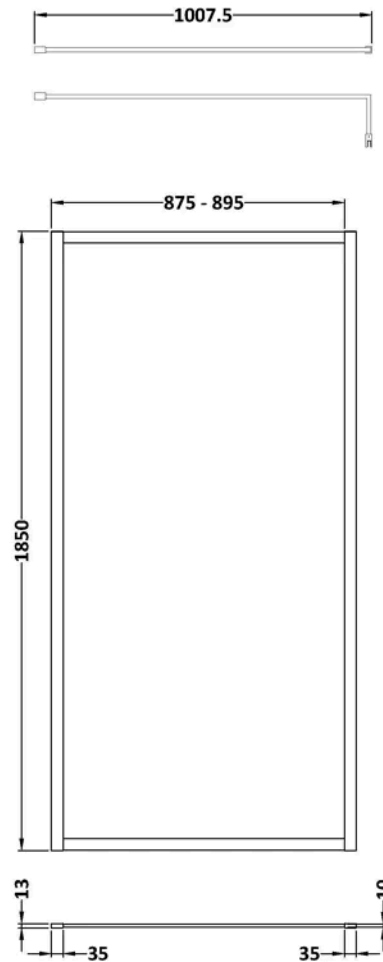
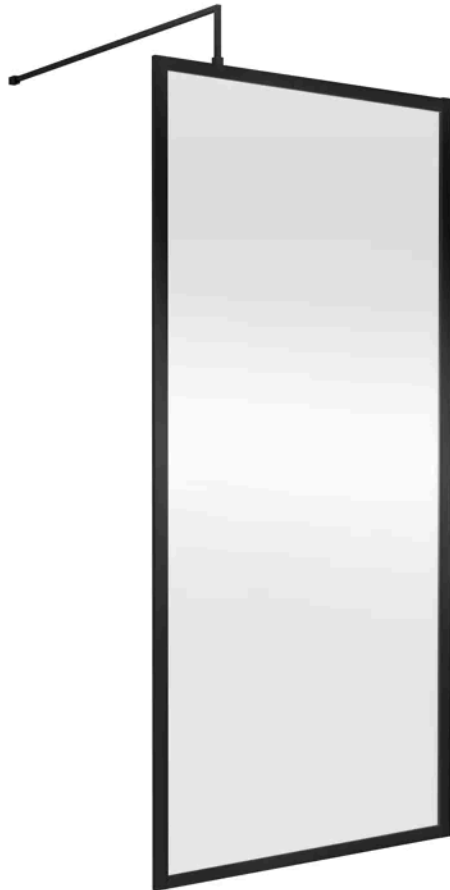

### Product Dimensions

Product	1850 x 900 x 13mm (H x W x D)
Packaged	550 x 550 x 550mm (H x W x D)
Nett Weight	39.78 kg
Packaged Weight	0 kg

### Product Details

Country of Origin	China
Product Material	Aluminium
Colour/Finish	Matt Black
Style	Contemporary
Easy Clean	No
Adjustment Max	900
Adjustment Min	880
Ce Certified	Yes
Easy Fit	No
Enclosure Design	Framed
Frame Finish	Matt Black
Glass Thickness	8 mm
Handles Included	No
Ukca Certified	Yes

**Sales Code:** FIX024

**Barcode:** 5056211847342

**Brand:** Hudson Reed

**Description:** Matt Black Wetroom Screen Support Arm

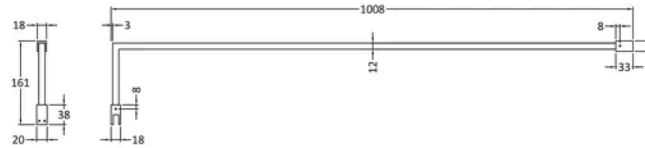

**Product Dimensions**

Product	15 x 150 x 1000mm (H x W x D)
Packaged	35 x 160 x 1020mm (H x W x D)
Nett Weight	0.67 kg
Packaged Weight	0.7 kg

**Product Details**

Country of Origin	China
Product Material	Stainless Steel
Colour/Finish	Matt Black
Style	Contemporary

**Sales Code:** WRSF004UF

**Barcode:** 5056462618968

**Brand:** nuie

**Description:** 1950mm Undrilled Flat Profile

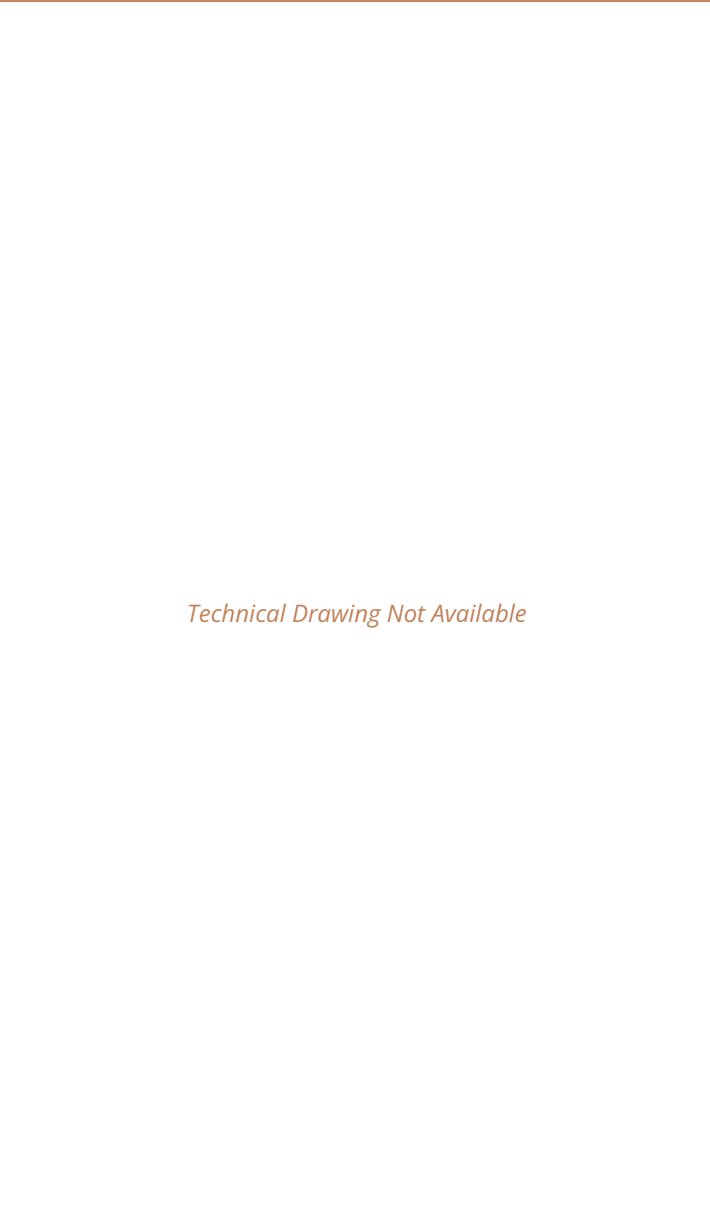
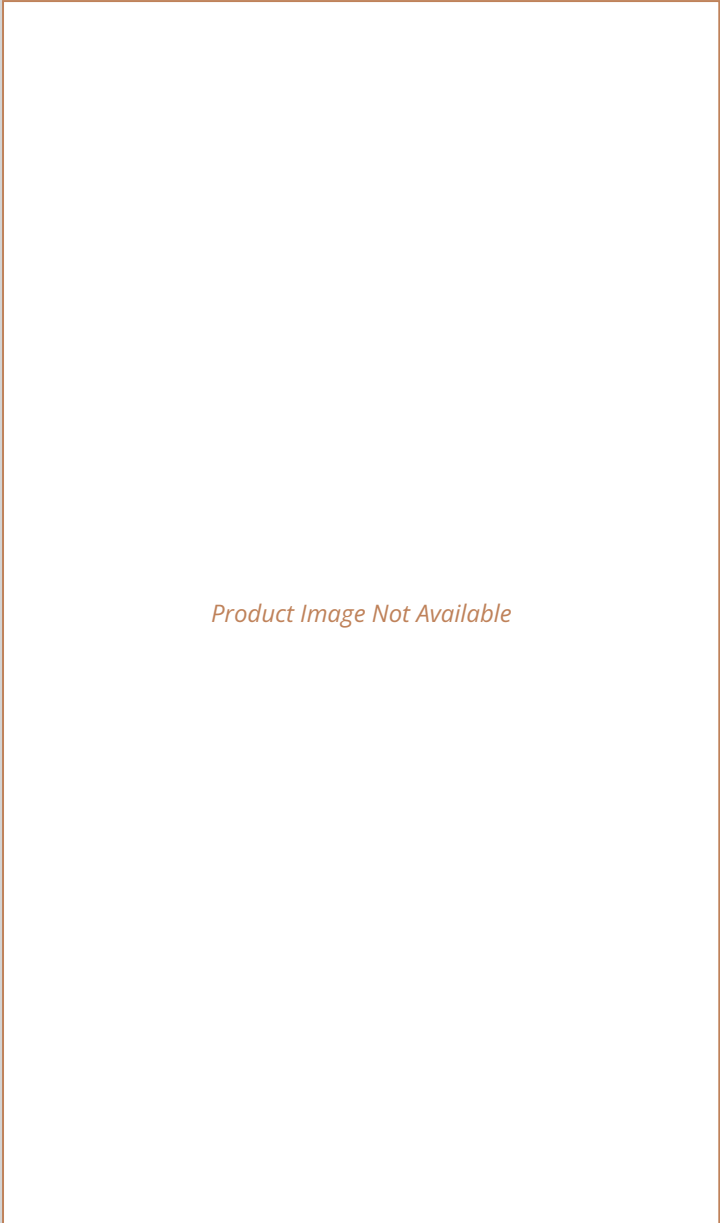

**Product Dimensions**

Product	45 x 185 x 1970mm (H x W x D)
Packaged	400 x 50 x 1970mm (H x W x D)
Nett Weight	1.01 kg
Packaged Weight	1.42 kg

**Product Details**

Country of Origin	China
Product Material	Aluminium
Colour/Finish	Matt Black
Style	Contemporary

**Sales Code:** WRSF009

**Barcode:** 5056211897224

**Brand:** nuie

**Description:** Matt Black 1850mm Wetroom Wall Channel

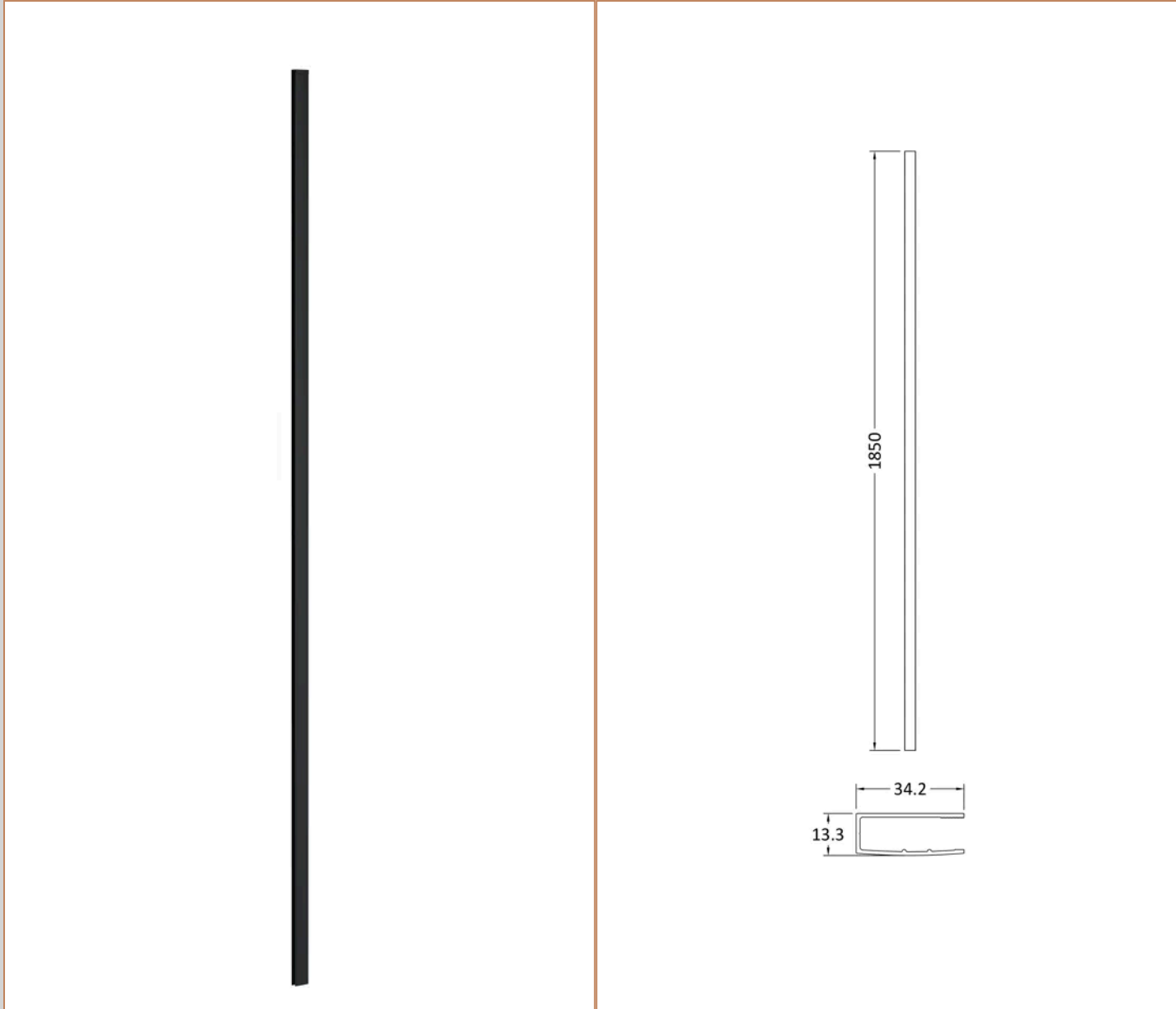

**Product Dimensions**

Product	60 x 185 x 1860mm (H x W x D)
Packaged	400 x 50 x 1860mm (H x W x D)
Nett Weight	0.6 kg
Packaged Weight	0.6 kg

**Product Details**

Product Material	Aluminium
------------------	-----------

**Sales Code:** WRFBP1810

**Barcode:** 5056462688497

**Brand:** nuie

**Description:** nuie 1000mm Matt Black Outer Frame Wetroom Screen

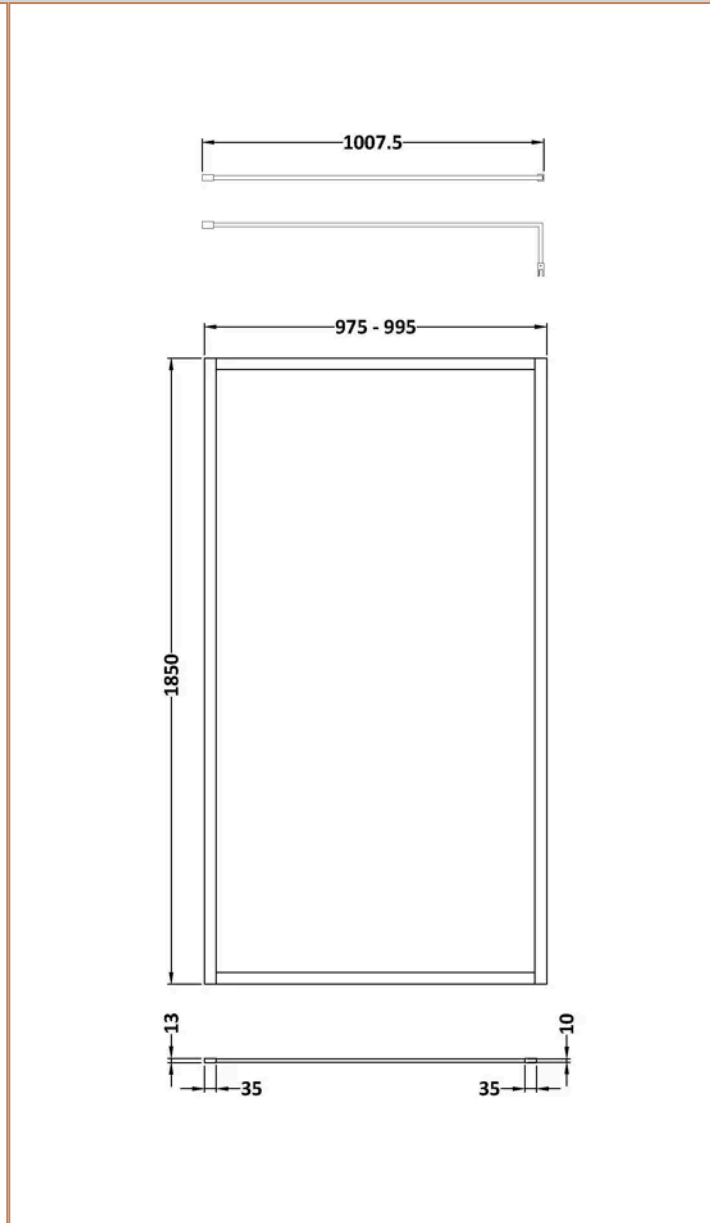
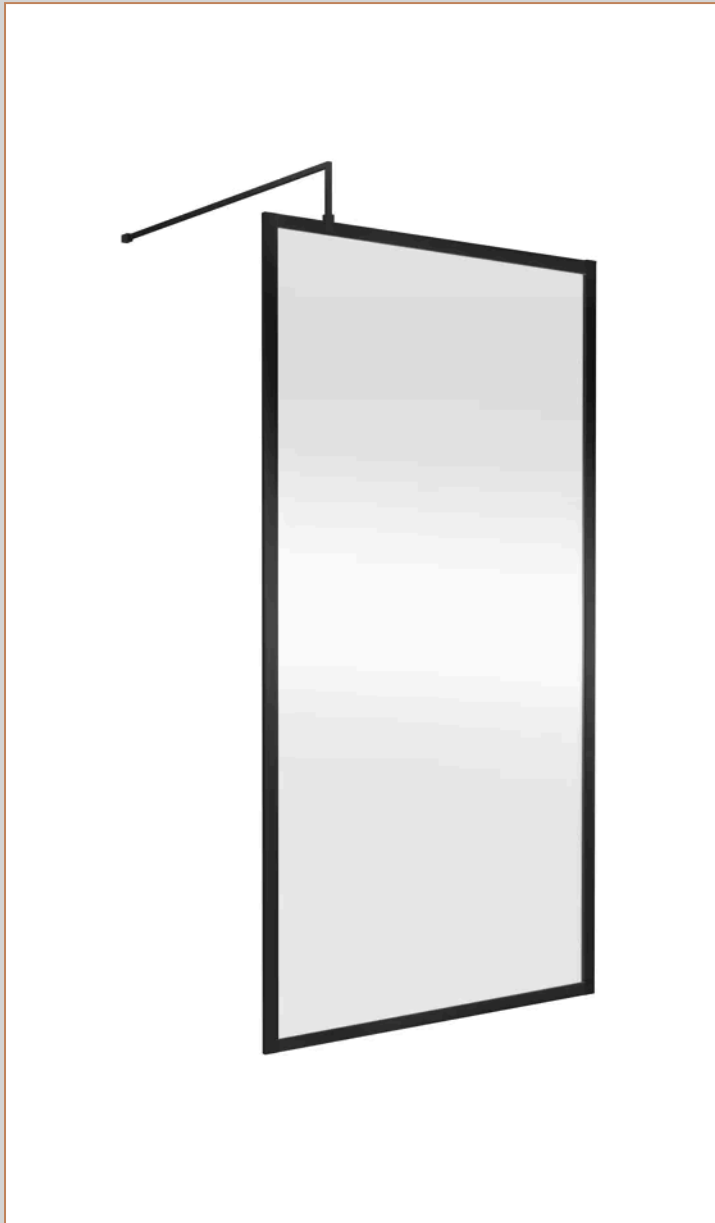

### Product Dimensions

Product	1850 x 1000 x 13mm (H x W x D)
Packaged	550 x 550 x 550mm (H x W x D)
Nett Weight	44.78 kg
Packaged Weight	0 kg

### Product Details

Country of Origin	China
Product Material	Aluminium
Colour/Finish	Matt Black
Style	Contemporary
Easy Clean	No
Adjustment Max	1000
Adjustment Min	980
Ce Certified	Yes
Easy Fit	No
Enclosure Design	Framed
Frame Finish	Matt Black
Glass Thickness	8 mm
Handles Included	No
Ukca Certified	Yes

**Sales Code:** FIX024

**Barcode:** 5056211847342

**Brand:** Hudson Reed

**Description:** Matt Black Wetroom Screen Support Arm

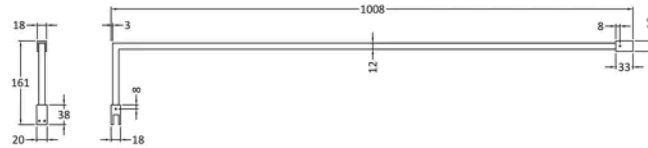

### Product Dimensions

Product	15 x 150 x 1000mm (H x W x D)
Packaged	35 x 160 x 1020mm (H x W x D)
Nett Weight	0.67 kg
Packaged Weight	0.7 kg

### Product Details

Country of Origin	China
Product Material	Stainless Steel
Colour/Finish	Matt Black
Style	Contemporary

**Sales Code:** WRSF004UF

**Barcode:** 5056462618968

**Brand:** nuie

**Description:** 1950mm Undrilled Flat Profile

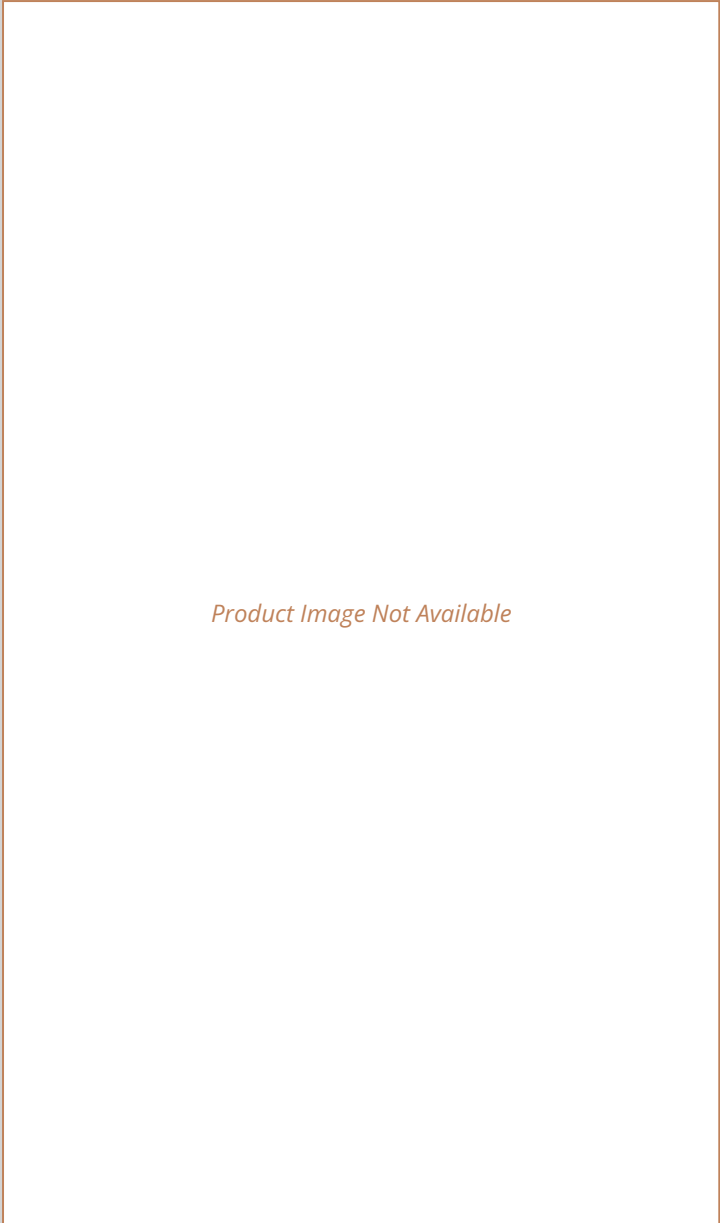

**Product Dimensions**

Product	45 x 185 x 1970mm (H x W x D)
Packaged	400 x 50 x 1970mm (H x W x D)
Nett Weight	1.01 kg
Packaged Weight	1.42 kg

**Product Details**

Country of Origin	China
Product Material	Aluminium
Colour/Finish	Matt Black
Style	Contemporary

**Sales Code:** WRSF009

**Barcode:** 5056211897224

**Brand:** nuie

**Description:** Matt Black 1850mm Wetroom Wall Channel

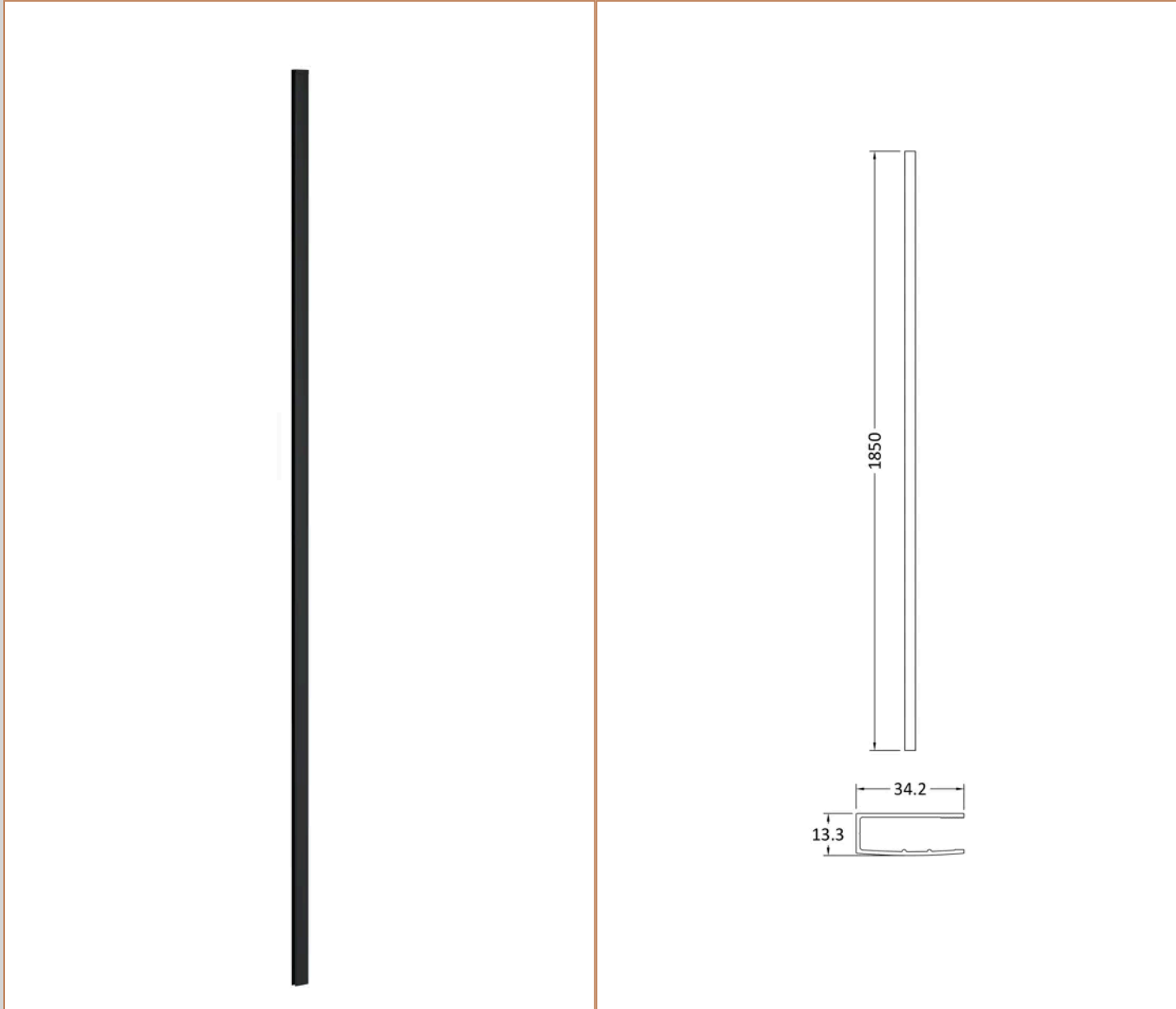

**Product Dimensions**

Product	60 x 185 x 1860mm (H x W x D)
Packaged	400 x 50 x 1860mm (H x W x D)
Nett Weight	0.6 kg
Packaged Weight	0.6 kg

**Product Details**

Product Material	Aluminium
------------------	-----------

**Sales Code:** WRFBP1811

**Barcode:** 5056462688503

**Brand:** nuie

**Description:** nuie 1100mm Matt Black Outer Frame Wetroom Screen

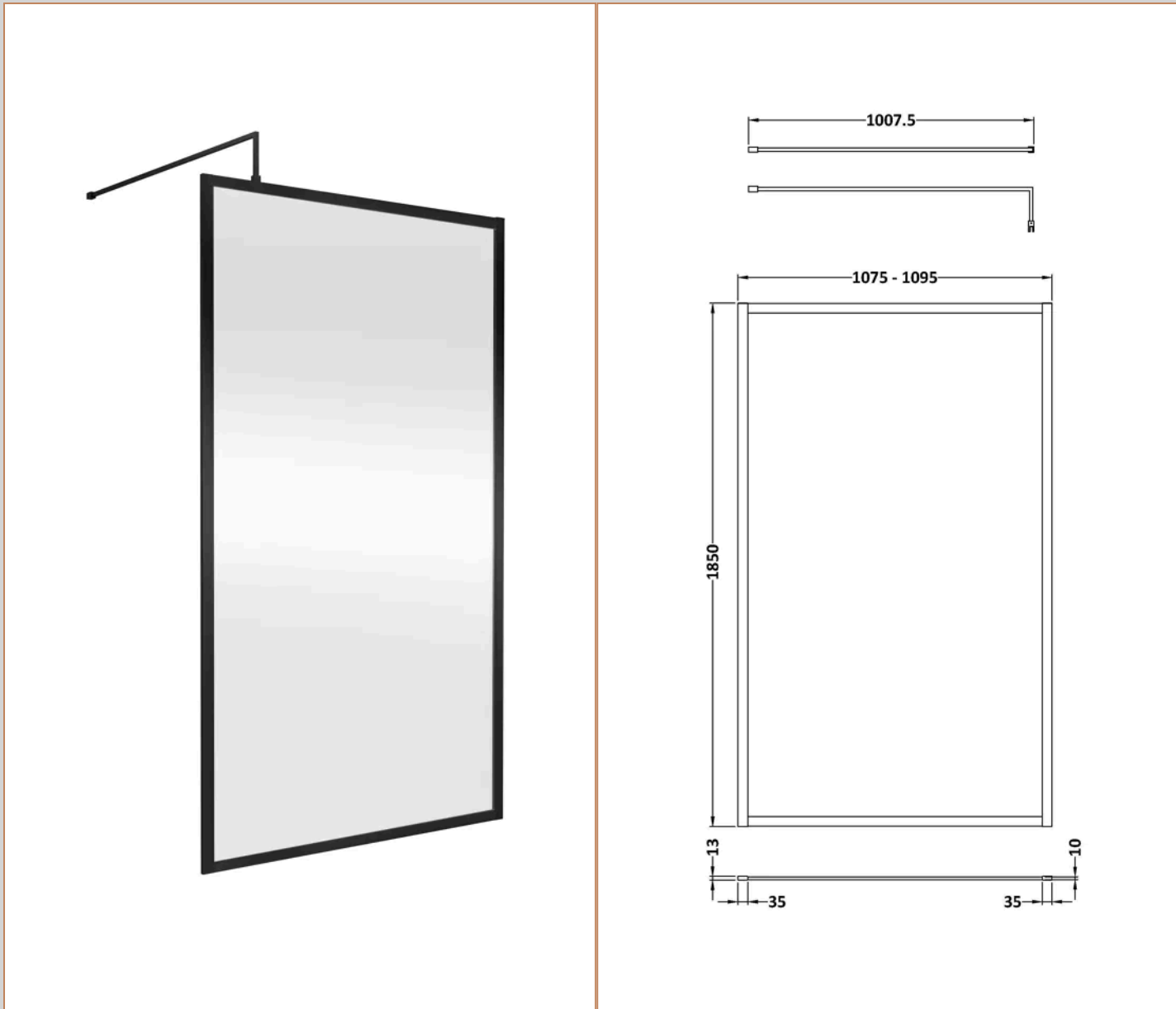

### Product Dimensions

Product	1850 x 1100 x 13mm (H x W x D)
Packaged	550 x 550 x 550mm (H x W x D)
Nett Weight	48.28 kg
Packaged Weight	0 kg

### Product Details

Country of Origin	China
Product Material	Aluminium
Colour/Finish	Matt Black
Style	Contemporary
Easy Clean	No
Adjustment Max	1093
Adjustment Min	1075
Ce Certified	Yes
Easy Fit	No
Enclosure Design	Framed
Frame Finish	Matt Black
Glass Thickness	8 mm
Handles Included	No
Ukca Certified	Yes

**Sales Code:** FIX024

**Barcode:** 5056211847342

**Brand:** Hudson Reed

**Description:** Matt Black Wetroom Screen Support Arm

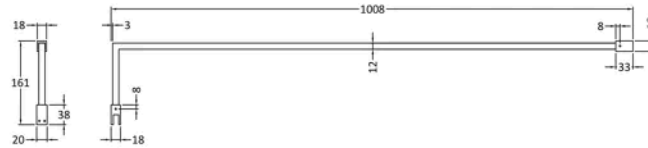

### Product Dimensions

Product	15 x 150 x 1000mm (H x W x D)
Packaged	35 x 160 x 1020mm (H x W x D)
Nett Weight	0.67 kg
Packaged Weight	0.7 kg

### Product Details

Country of Origin	China
Product Material	Stainless Steel
Colour/Finish	Matt Black
Style	Contemporary

**Sales Code:** WRSF004UF

**Barcode:** 5056462618968

**Brand:** nuie

**Description:** 1950mm Undrilled Flat Profile

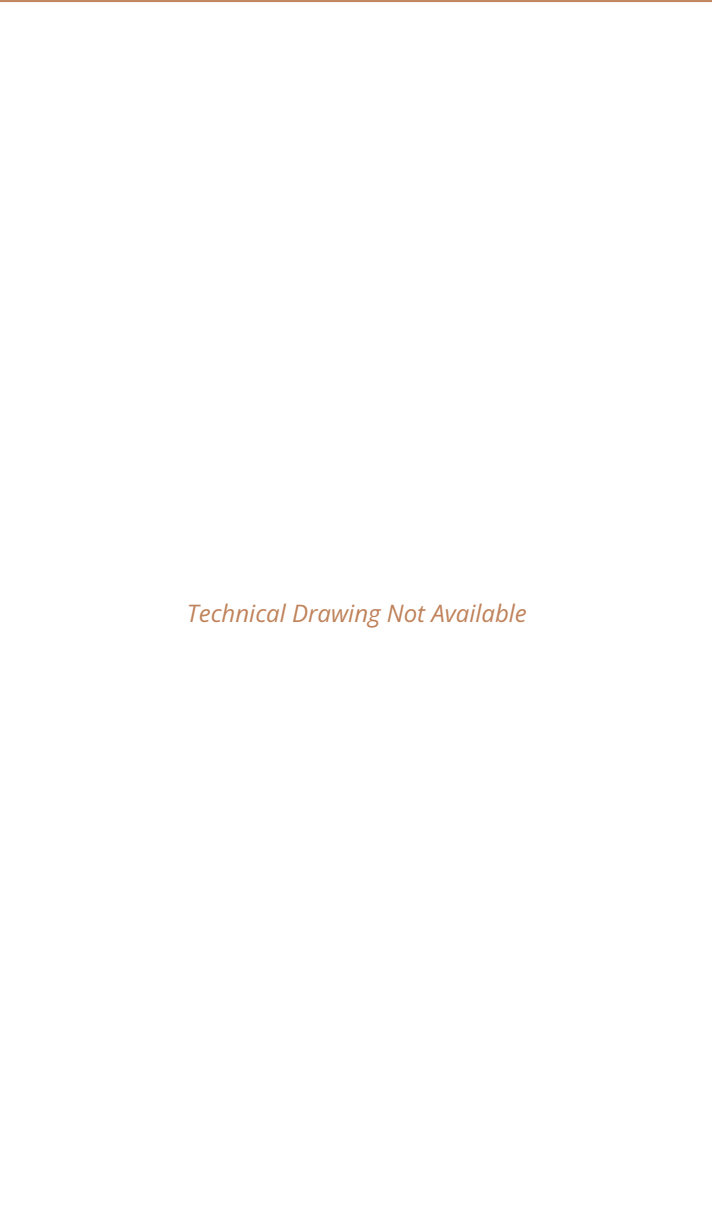
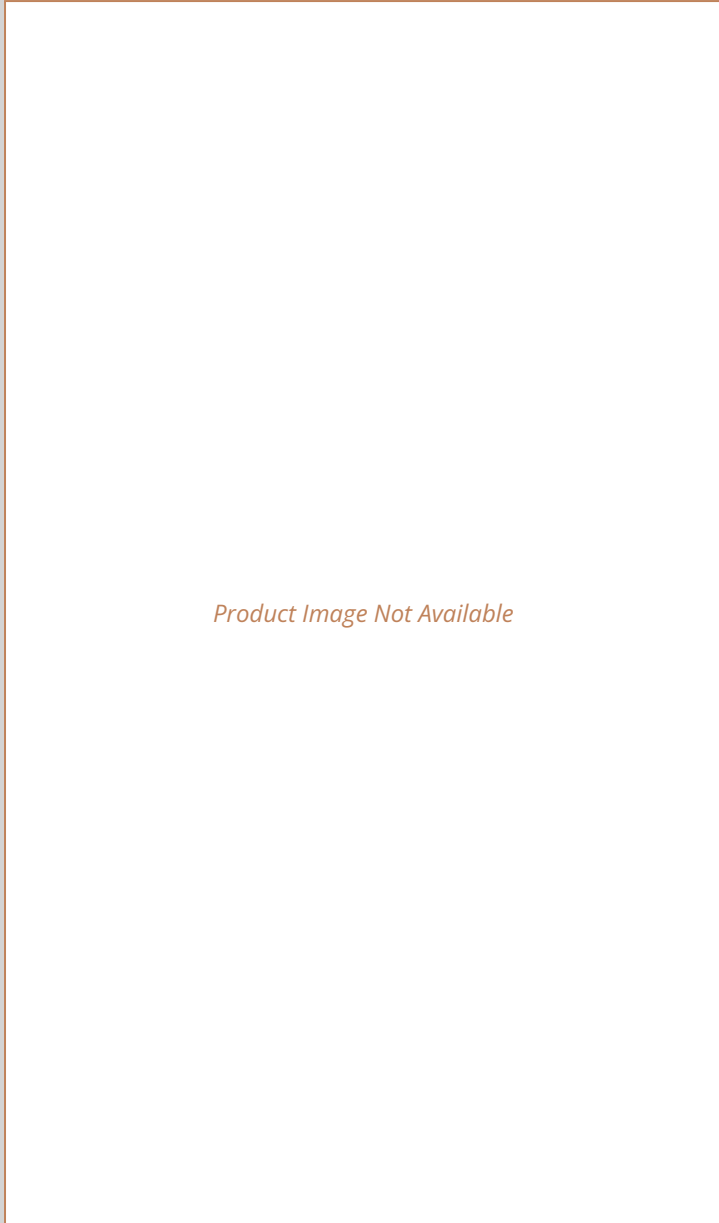

**Product Dimensions**

Product	45 x 185 x 1970mm (H x W x D)
Packaged	400 x 50 x 1970mm (H x W x D)
Nett Weight	1.01 kg
Packaged Weight	1.42 kg

**Product Details**

Country of Origin	China
Product Material	Aluminium
Colour/Finish	Matt Black
Style	Contemporary

**Sales Code:** WRSF009

**Barcode:** 5056211897224

**Brand:** nuie

**Description:** Matt Black 1850mm Wetroom Wall Channel

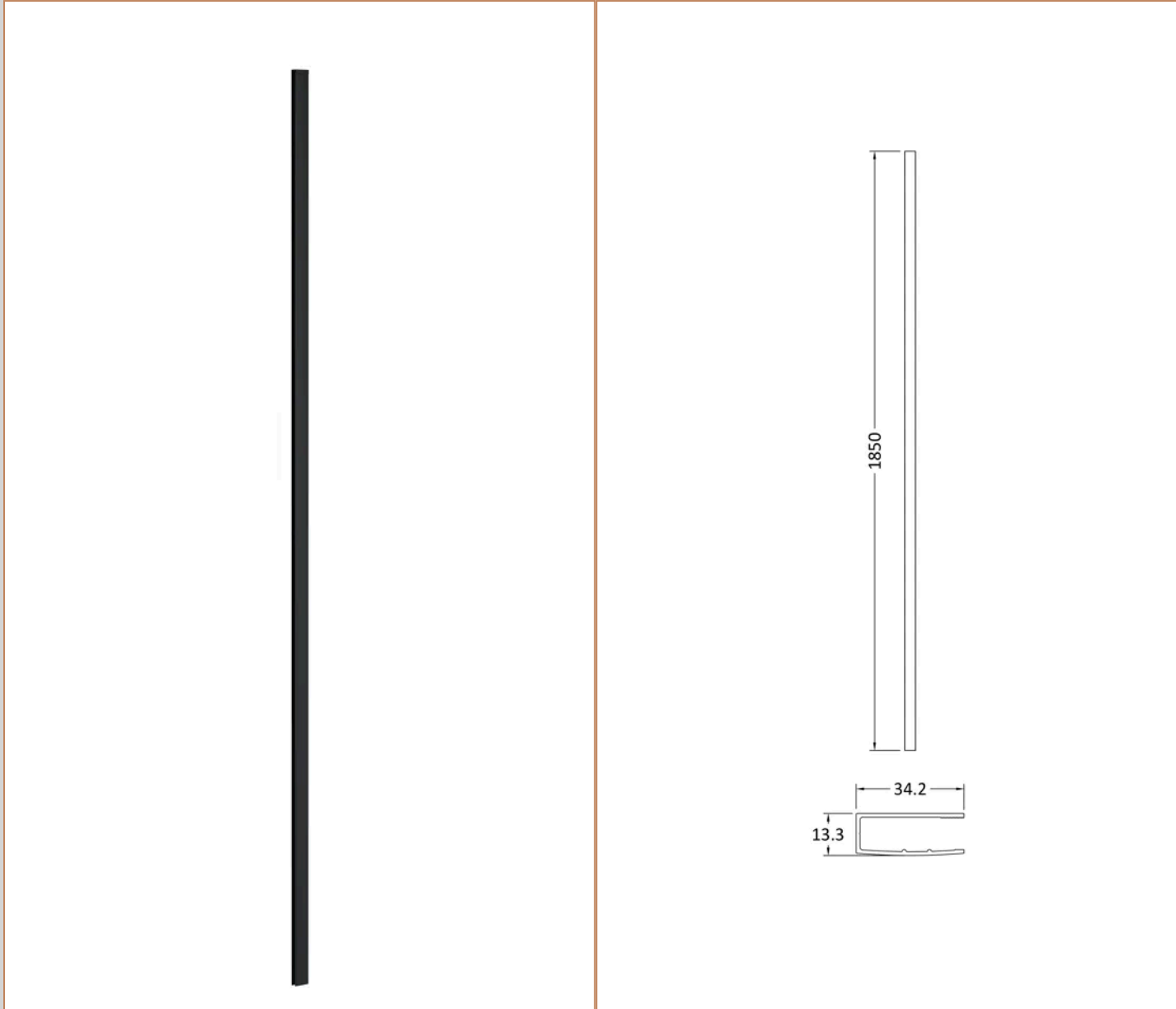

**Product Dimensions**

Product	60 x 185 x 1860mm (H x W x D)
Packaged	400 x 50 x 1860mm (H x W x D)
Nett Weight	0.6 kg
Packaged Weight	0.6 kg

**Product Details**

Product Material	Aluminium
------------------	-----------

**Sales Code:** WRFBP1812

**Barcode:** 5056462688510

**Brand:** nuie

**Description:** nuie 1200mm Matt Black Outer Frame Wetroom Screen

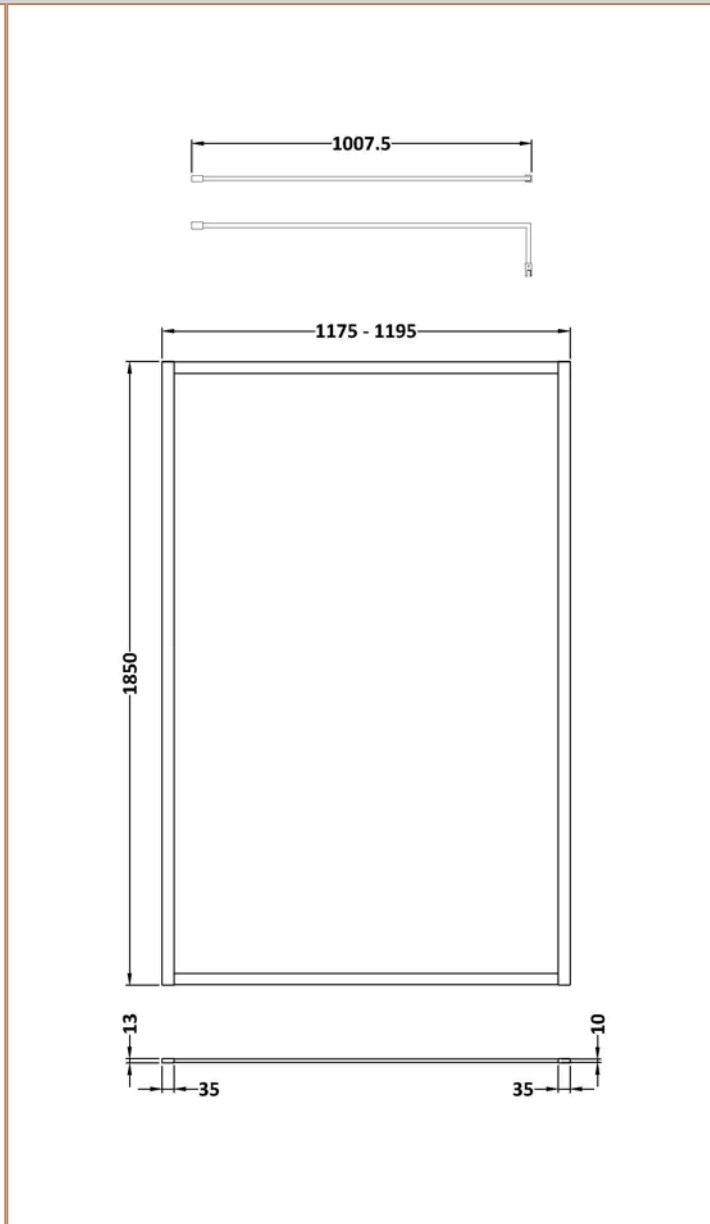
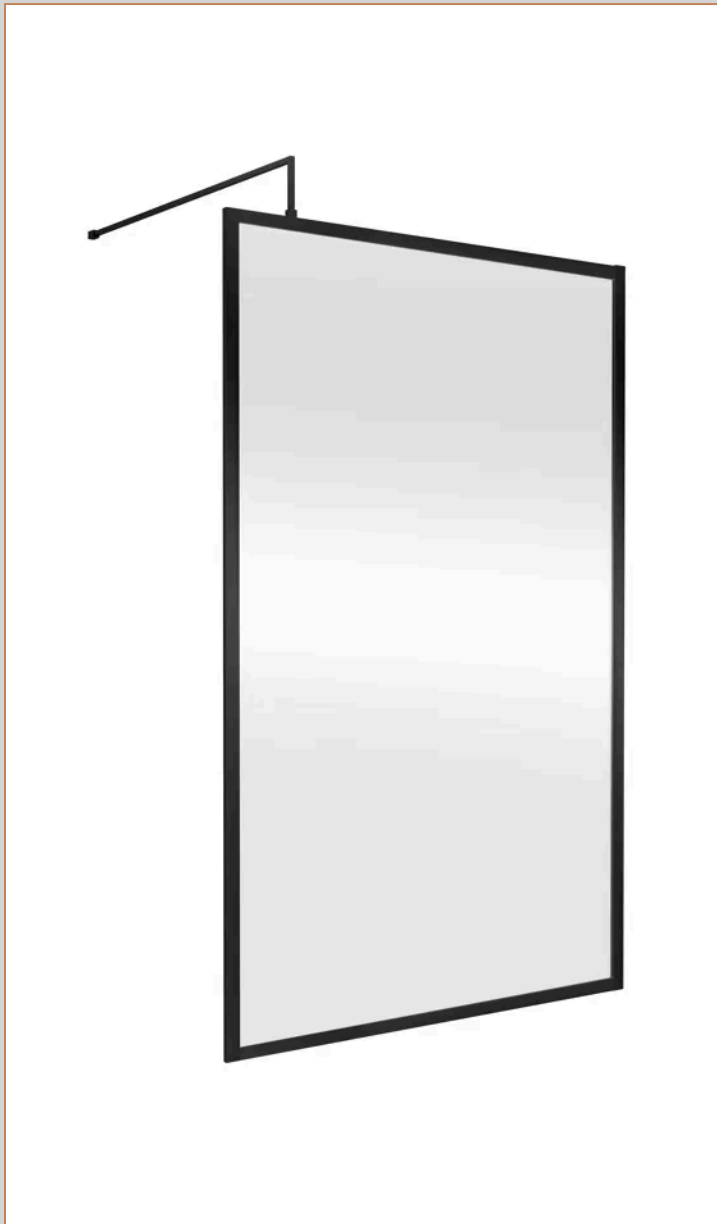

### Product Dimensions

Product	1850 x 1200 x 13mm (H x W x D)
Packaged	550 x 550 x 550mm (H x W x D)
Nett Weight	52.78 kg
Packaged Weight	0 kg

### Product Details

Country of Origin	China
Product Material	Aluminium
Colour/Finish	Matt Black
Style	Contemporary
Easy Clean	No
Adjustment Max	1200
Adjustment Min	1180
Ce Certified	Yes
Easy Fit	No
Enclosure Design	Framed
Frame Finish	Matt Black
Glass Thickness	8 mm
Handles Included	No
Ukca Certified	Yes

**Sales Code:** FIX024

**Barcode:** 5056211847342

**Brand:** Hudson Reed

**Description:** Matt Black Wetroom Screen Support Arm

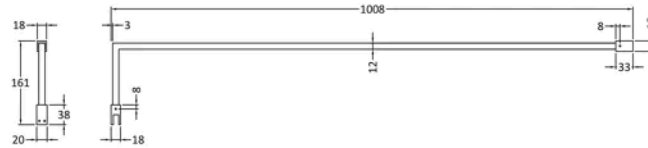

### Product Dimensions

Product	15 x 150 x 1000mm (H x W x D)
Packaged	35 x 160 x 1020mm (H x W x D)
Nett Weight	0.67 kg
Packaged Weight	0.7 kg

### Product Details

Country of Origin	China
Product Material	Stainless Steel
Colour/Finish	Matt Black
Style	Contemporary

**Sales Code:** WRSF004UF

**Barcode:** 5056462618968

**Brand:** nuie

**Description:** 1950mm Undrilled Flat Profile

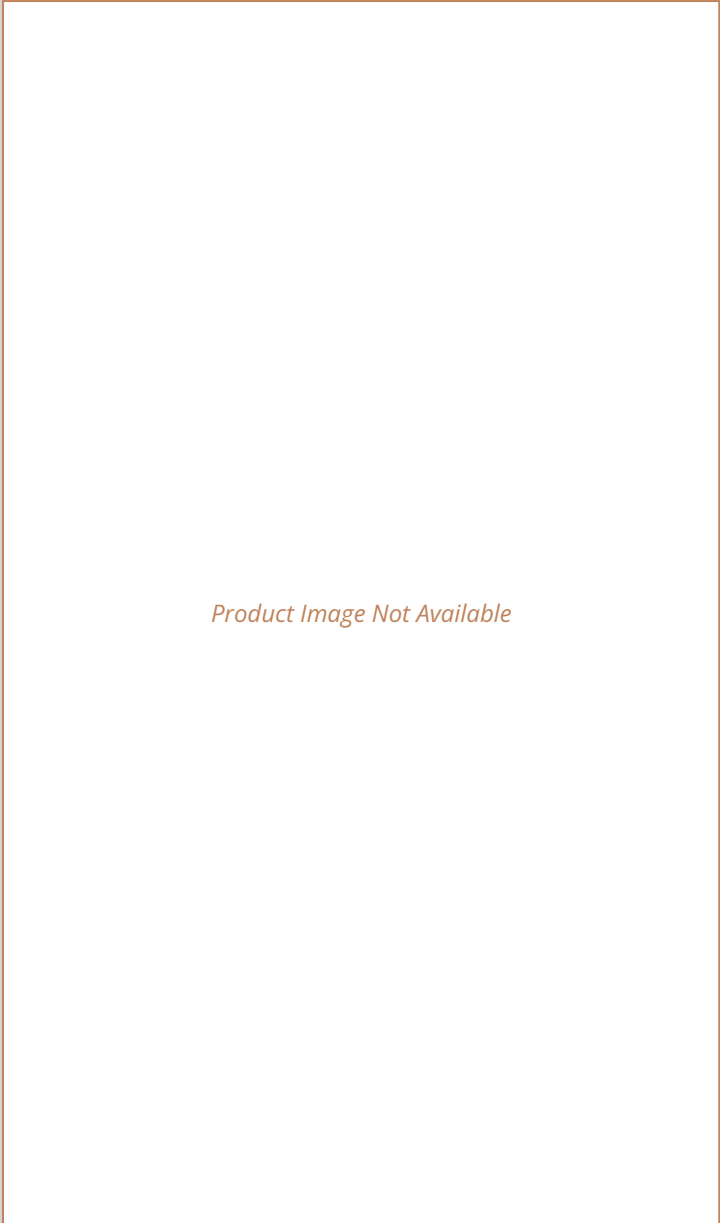

**Product Dimensions**

Product	45 x 185 x 1970mm (H x W x D)
Packaged	400 x 50 x 1970mm (H x W x D)
Nett Weight	1.01 kg
Packaged Weight	1.42 kg

**Product Details**

Country of Origin	China
Product Material	Aluminium
Colour/Finish	Matt Black
Style	Contemporary

**Sales Code:** WRSF009

**Barcode:** 5056211897224

**Brand:** nuie

**Description:** Matt Black 1850mm Wetroom Wall Channel

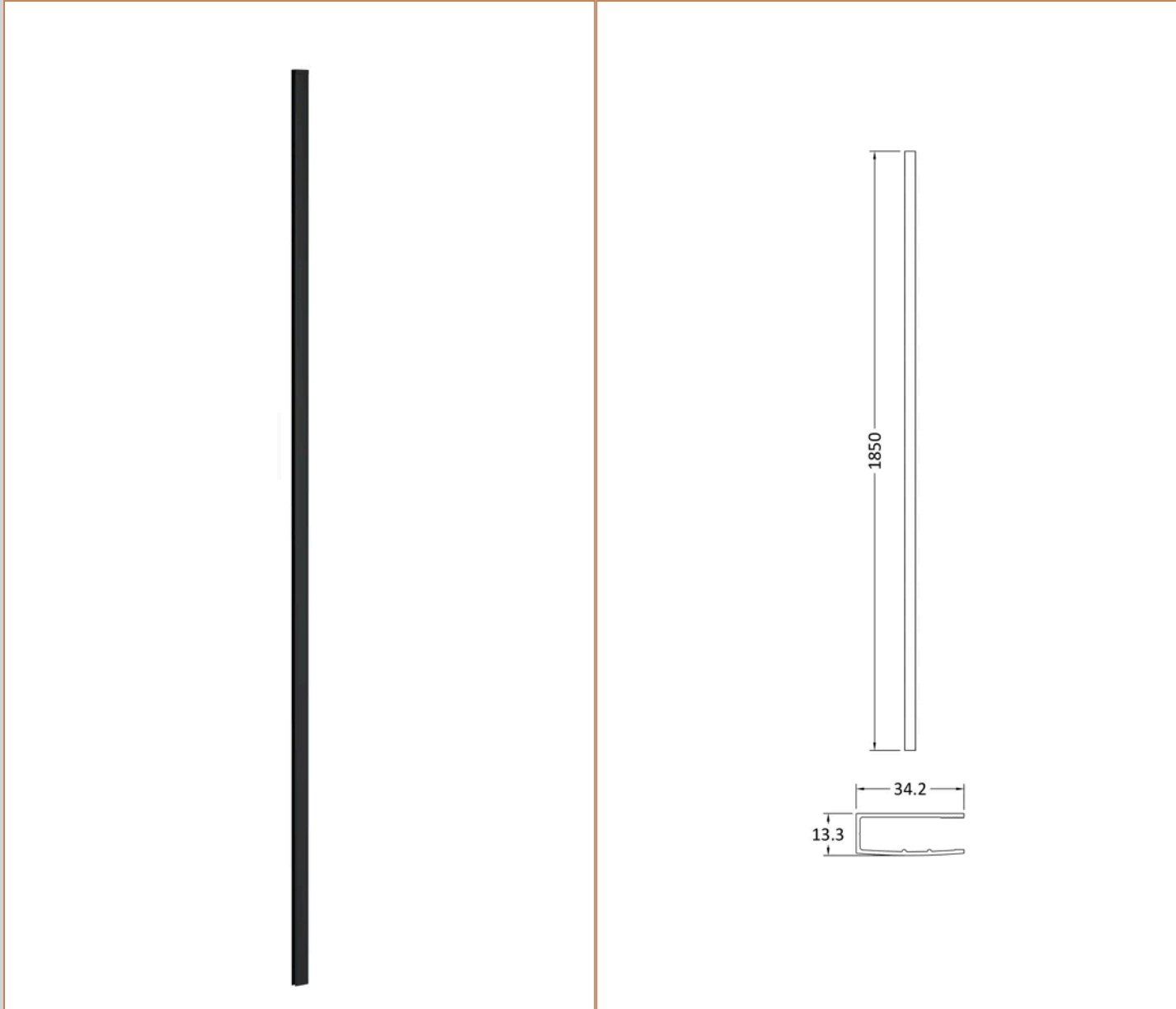

**Product Dimensions**

Product	60 x 185 x 1860mm (H x W x D)
Packaged	400 x 50 x 1860mm (H x W x D)
Nett Weight	0.6 kg
Packaged Weight	0.6 kg

**Product Details**

Product Material	Aluminium
------------------	-----------

**Sales Code:** WRFBP1814

**Barcode:** 5056462688527

**Brand:** nuie

**Description:** nuie 1400mm Matt Black Outer Frame Wetroom Screen

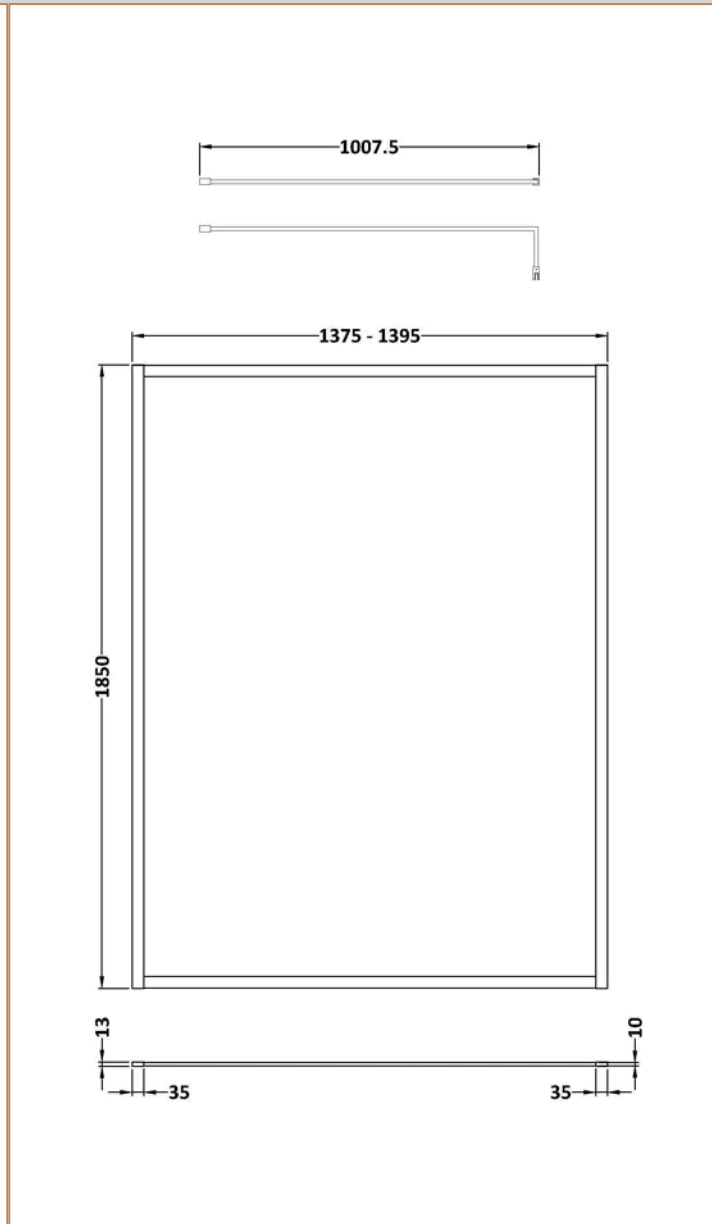
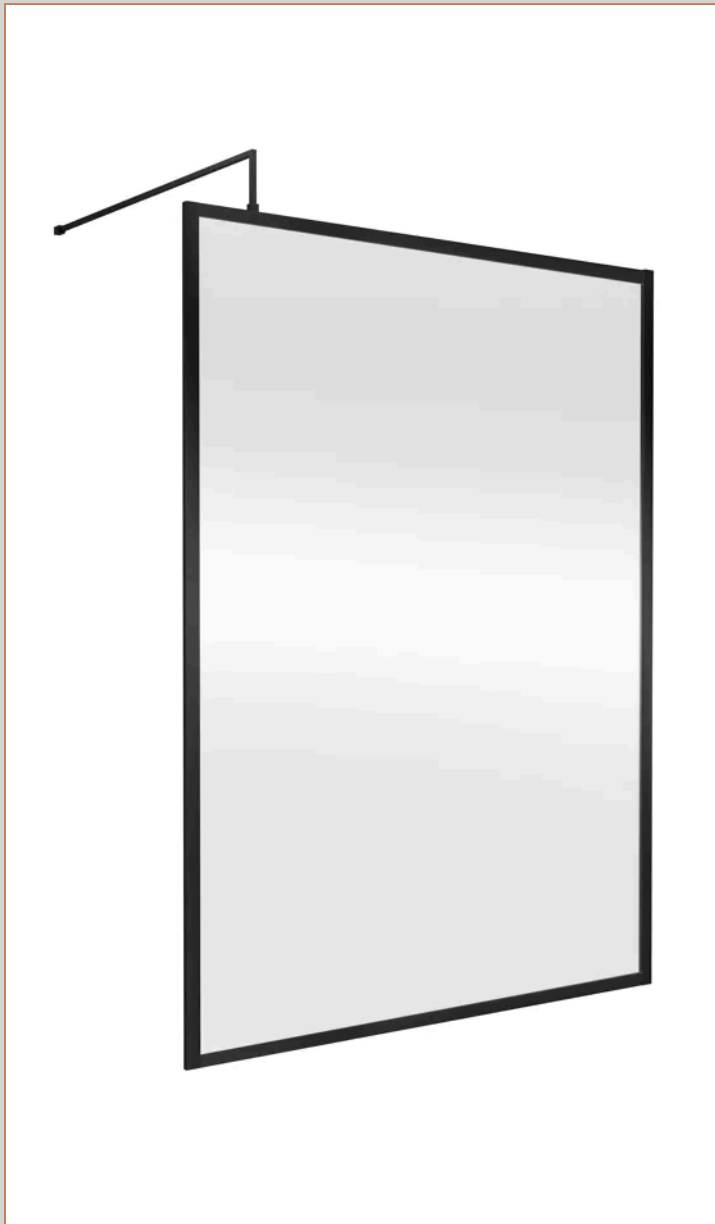

### Product Dimensions

Product	1850 x 1400 x 13mm (H x W x D)
Packaged	550 x 550 x 550mm (H x W x D)
Nett Weight	61.78 kg
Packaged Weight	0 kg

### Product Details

Country of Origin	China
Product Material	Aluminium
Colour/Finish	Matt Black
Style	Contemporary
Easy Clean	No
Adjustment Max	1400
Adjustment Min	1380
Ce Certified	Yes
Easy Fit	No
Enclosure Design	Framed
Frame Finish	Matt Black
Glass Thickness	8 mm
Handles Included	No
Ukca Certified	Yes

**Sales Code:** FIX024

**Barcode:** 5056211847342

**Brand:** Hudson Reed

**Description:** Matt Black Wetroom Screen Support Arm

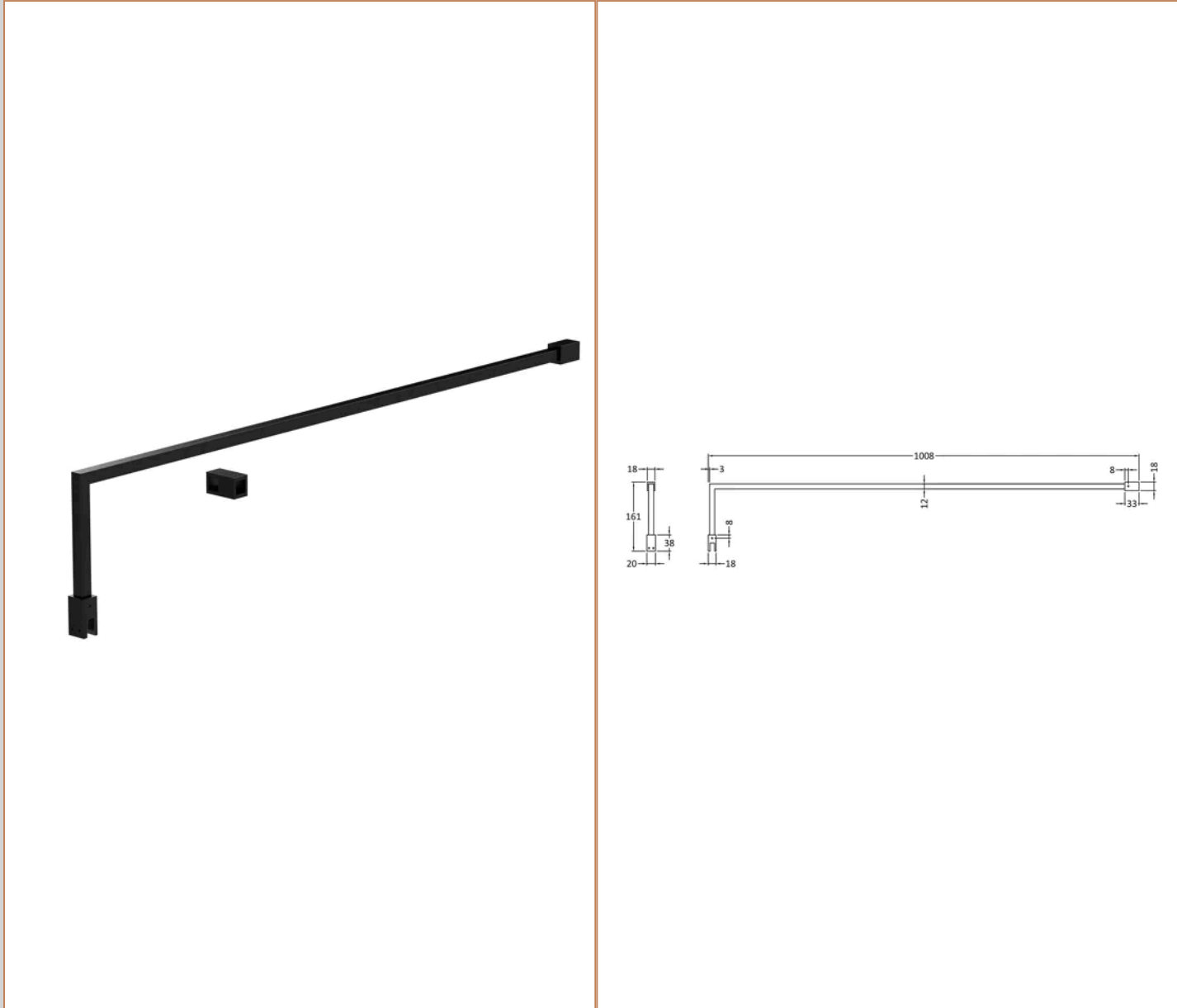

**Product Dimensions**

Product	15 x 150 x 1000mm (H x W x D)
Packaged	35 x 160 x 1020mm (H x W x D)
Nett Weight	0.67 kg
Packaged Weight	0.7 kg

**Product Details**

Country of Origin	China
Product Material	Stainless Steel
Colour/Finish	Matt Black
Style	Contemporary

**Sales Code:** WRSF004UF

**Barcode:** 5056462618968

**Brand:** nuie

**Description:** 1950mm Undrilled Flat Profile

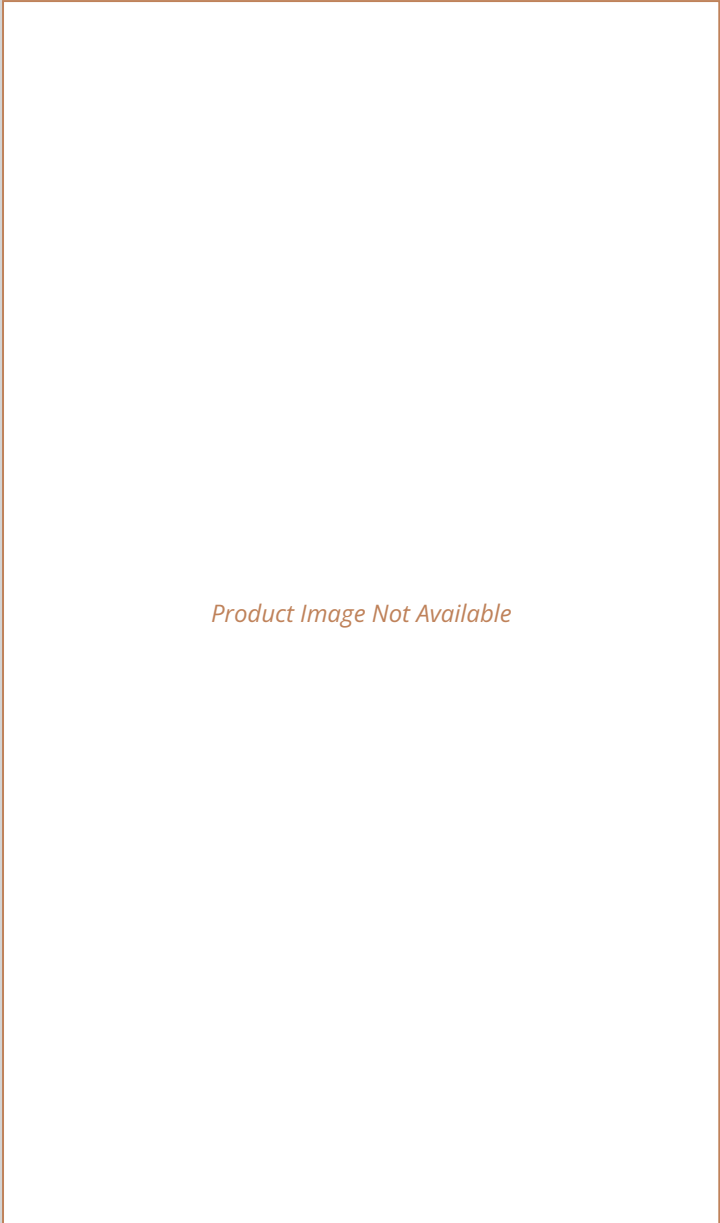

**Product Dimensions**

Product	45 x 185 x 1970mm (H x W x D)
Packaged	400 x 50 x 1970mm (H x W x D)
Nett Weight	1.01 kg
Packaged Weight	1.42 kg

**Product Details**

Country of Origin	China
Product Material	Aluminium
Colour/Finish	Matt Black
Style	Contemporary

**Sales Code:** WRSF009

**Barcode:** 5056211897224

**Brand:** nuie

**Description:** Matt Black 1850mm Wetroom Wall Channel

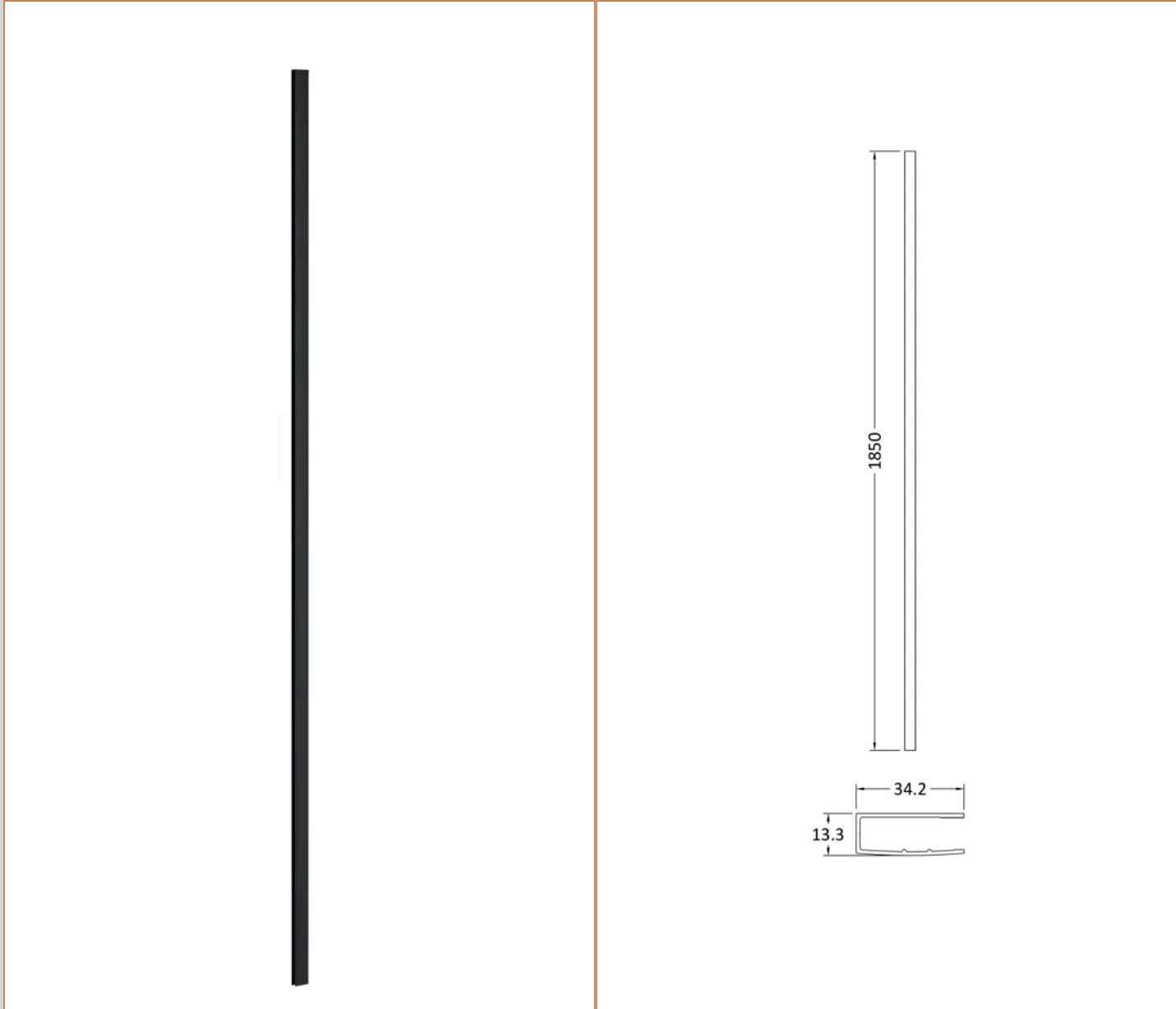

**Product Dimensions**

Product	60 x 185 x 1860mm (H x W x D)
Packaged	400 x 50 x 1860mm (H x W x D)
Nett Weight	0.6 kg
Packaged Weight	0.6 kg

**Product Details**

Product Material	Aluminium
------------------	-----------