

Sales Code: NWS1990

Barcode: 5056883732175

Brand: nuie

Description: nuie 900mm Chrome Wetroom Screen With Support Bar

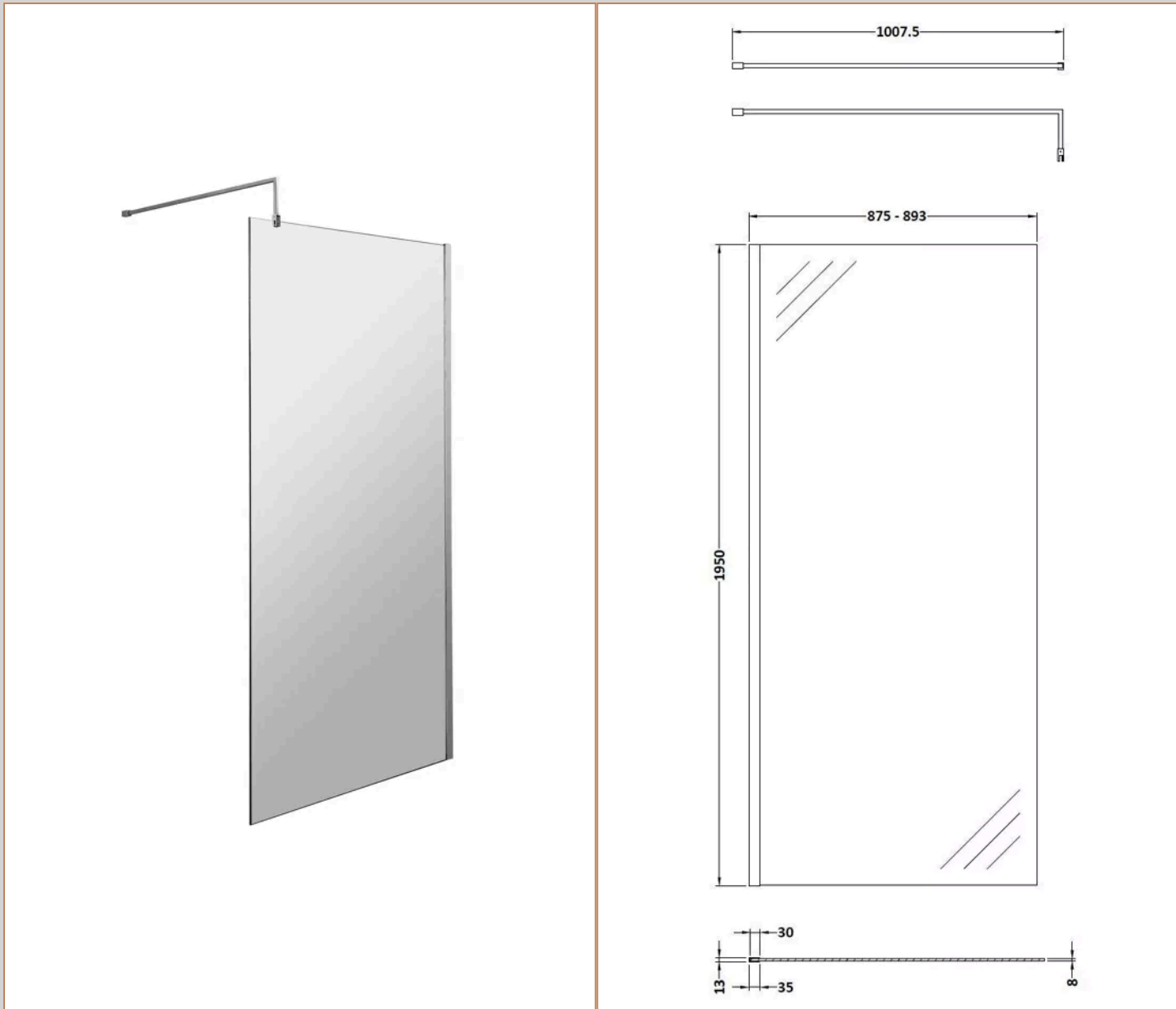

Product Dimensions

Product	1950 x 900 x 40mm (H x W x D)
Packaged	65 x 930 x 2010mm (H x W x D)
Nett Weight	38.24 kg
Packaged Weight	38.24 kg

Packaging Details

Label Size (mm)	50 x 100
-----------------	----------

Product Details

Country of Origin	China
Product Material	Aluminium
Colour/Finish	Chrome
Style	Contemporary
Easy Clean	Yes
Adjustment Max	893
Adjustment Min	875
Ce Certified	Yes
Declaration Of Performance	Yes
Easy Fit	No
Enclosure Design	Semi-Frameless
Frame Finish	Chrome
Glass Thickness	8 mm
Handles Included	No
Support Bar Included	Yes
Ukca Certified	Yes

Sales Code: FIX023

Barcode: 5056211800002

Brand: nuie

Description: Chrome Wetroom Screen Support Arm

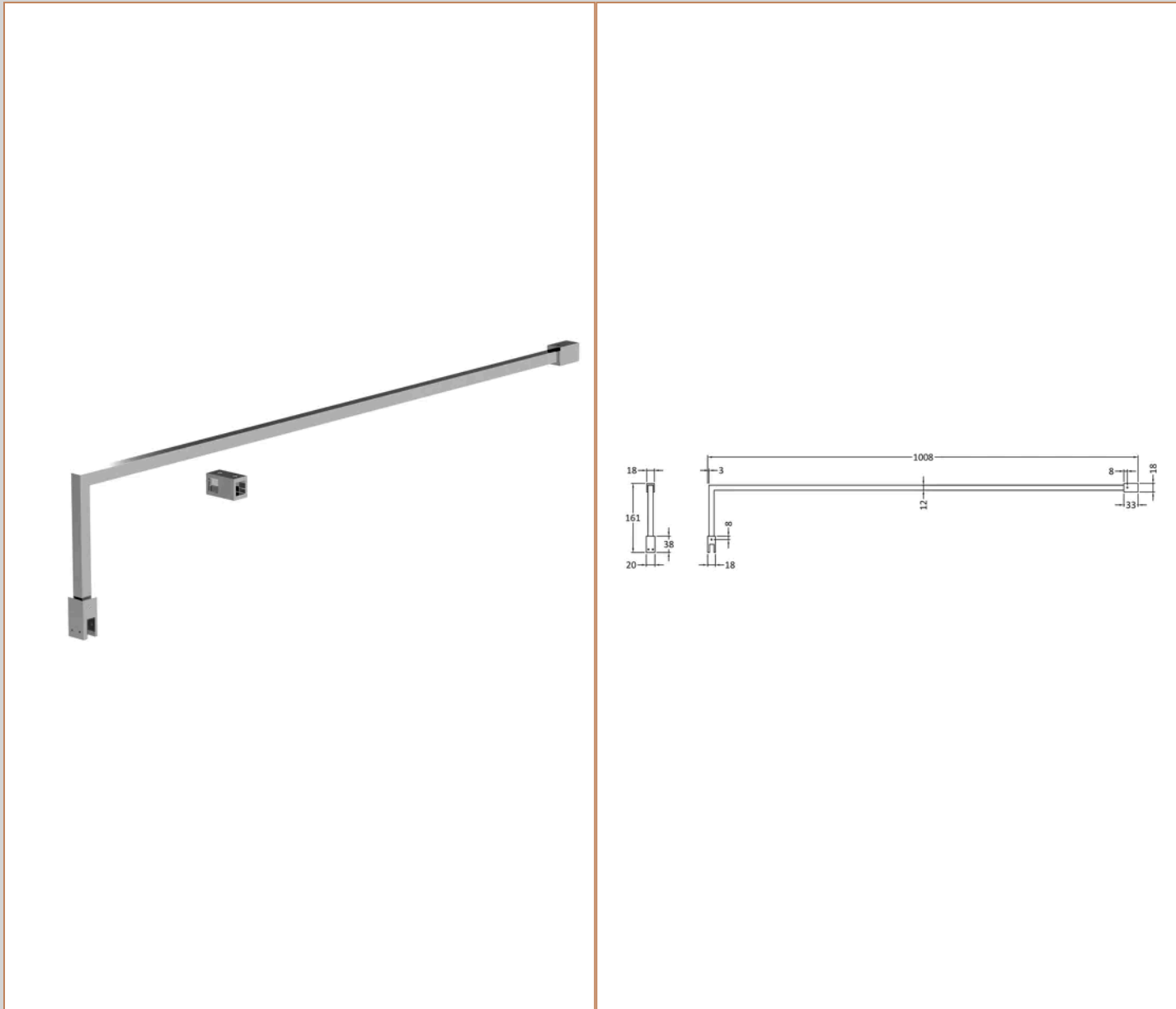

Product Dimensions

Product	150 x 15 x 1000mm (H x W x D)
Packaged	35 x 160 x 1020mm (H x W x D)
Nett Weight	0.67 kg
Packaged Weight	0.7 kg

Product Details

Country of Origin	China
Product Material	Stainless Steel
Colour/Finish	Chrome
Style	Contemporary

Sales Code: WRSB900G

Barcode: 5056462620749

Brand: OEM

Description: Missing title



Product Dimensions

Product	1950 x 900 x 8mm (H x W x D)
Packaged	2070 x 950 x 60mm (H x W x D)
Nett Weight	40.3 kg
Packaged Weight	40.3 kg

Product Details

Country of Origin	China
Easy Clean	No
Ce Certified	Yes
Easy Fit	No
Enclosure Design	Frameless
Glass Thickness	8 mm

Sales Code: WRSF018

Barcode: 5056462620695

Brand: Hudson Reed

Description: Hudson Reed Chrome Wetroom Screen

Product Image Not Available

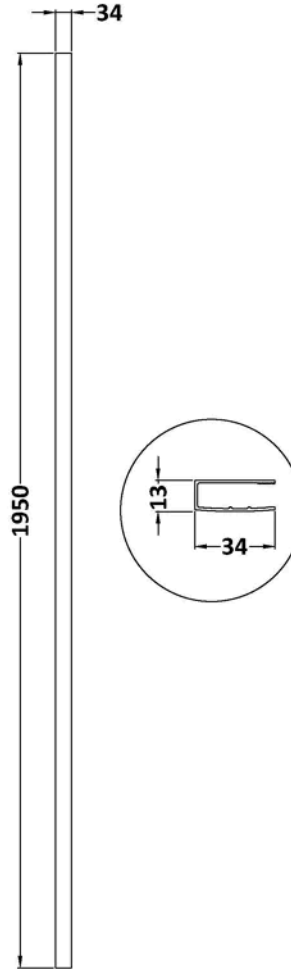

Product Dimensions

Product	1950mm (H)
Packaged	40 x 50 x 1970mm (H x W x D)
Nett Weight	0.8 kg
Packaged Weight	0.8 kg

Product Details

Country of Origin	China
Colour/Finish	Chrome
Ce Certified	Yes
Frame Finish	Chrome