

Sales Code: NWAF10

Barcode: 5056883734346

Brand: nuie

Description: nuie 1000mm Chrome Wetroom Panel

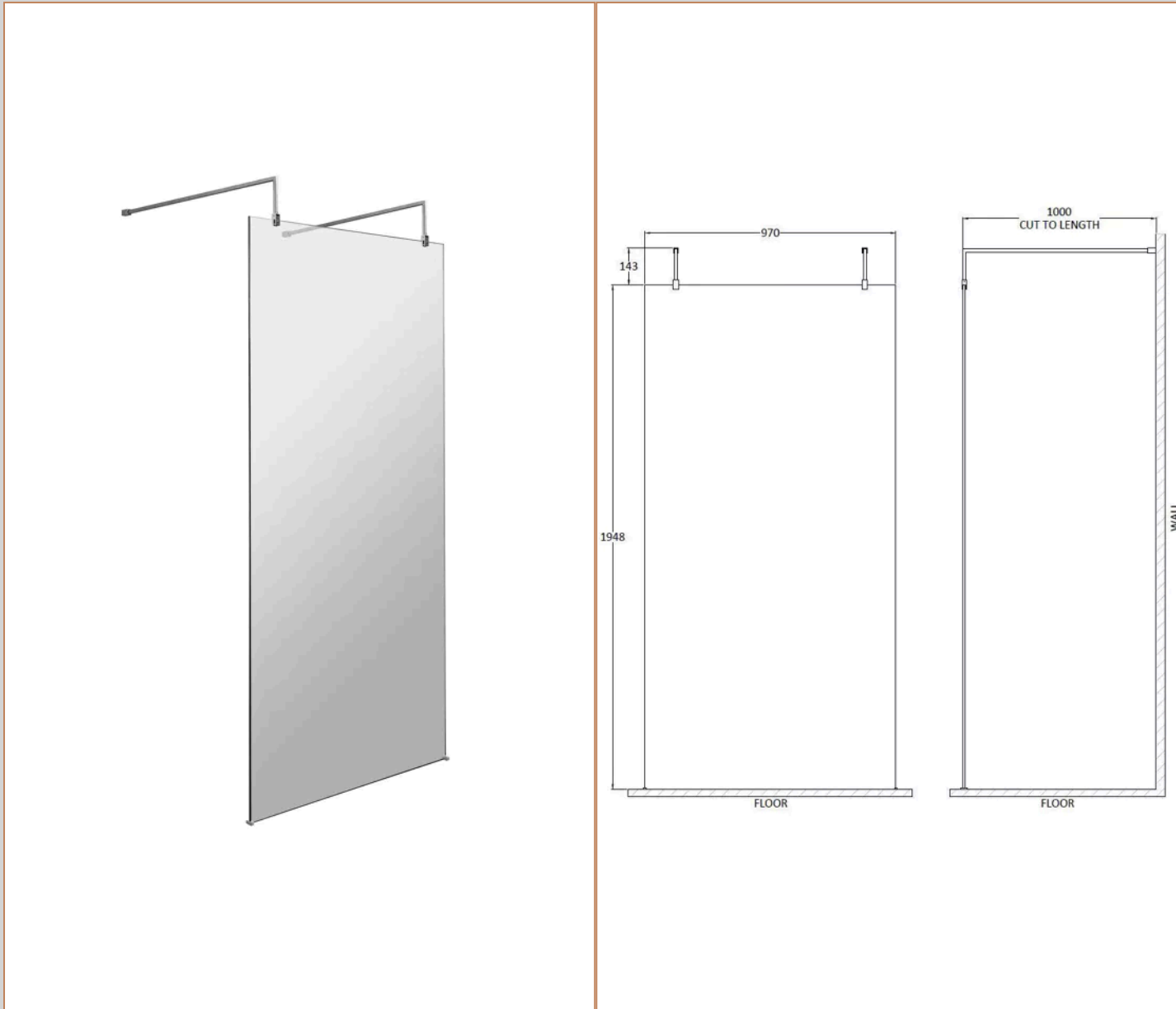

Product Dimensions

Product	1950 x 998 x 14mm (H x W x D)
Nett Weight	0 kg
Packaged Weight	0 kg

Product Details

Country of Origin	China
Product Material	Aluminium
Colour/Finish	Chrome
Style	Contemporary
Easy Clean	Yes
Ce Certified	Yes
Declaration Of Performance	Yes
Easy Fit	No
Enclosure Design	Frameless
Frame Finish	Chrome
Glass Thickness	8 mm
Handles Included	No
Ukca Certified	Yes

Sales Code: FIX023

Barcode: 5056211800002

Brand: nuie

Description: Chrome Wetroom Screen Support Arm

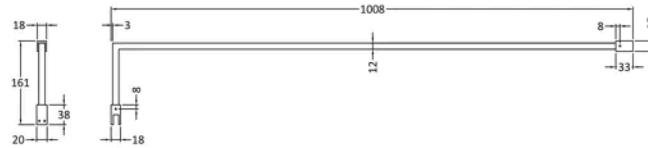

Product Dimensions

Product	150 x 15 x 1000mm (H x W x D)
Packaged	35 x 160 x 1020mm (H x W x D)
Nett Weight	0.67 kg
Packaged Weight	0.7 kg

Product Details

Country of Origin	China
Product Material	Stainless Steel
Colour/Finish	Chrome
Style	Contemporary

Sales Code: WRSB1000G

Barcode: 5056462620756

Brand: OEM

Description: Missing title



Product Dimensions

Product	1950 x 1000 x 8mm (H x W x D)
Packaged	2070 x 1050 x 60mm (H x W x D)
Nett Weight	44.8 kg
Packaged Weight	44.8 kg

Product Details

Country of Origin	China
Easy Clean	No
Ce Certified	Yes
Easy Fit	No
Enclosure Design	Frameless
Glass Thickness	8 mm

Sales Code: WRSF003

Barcode: 5055275896228

Brand: Hudson Reed

Description: Polished Chrome Wetroom Screen Horseshoe Support

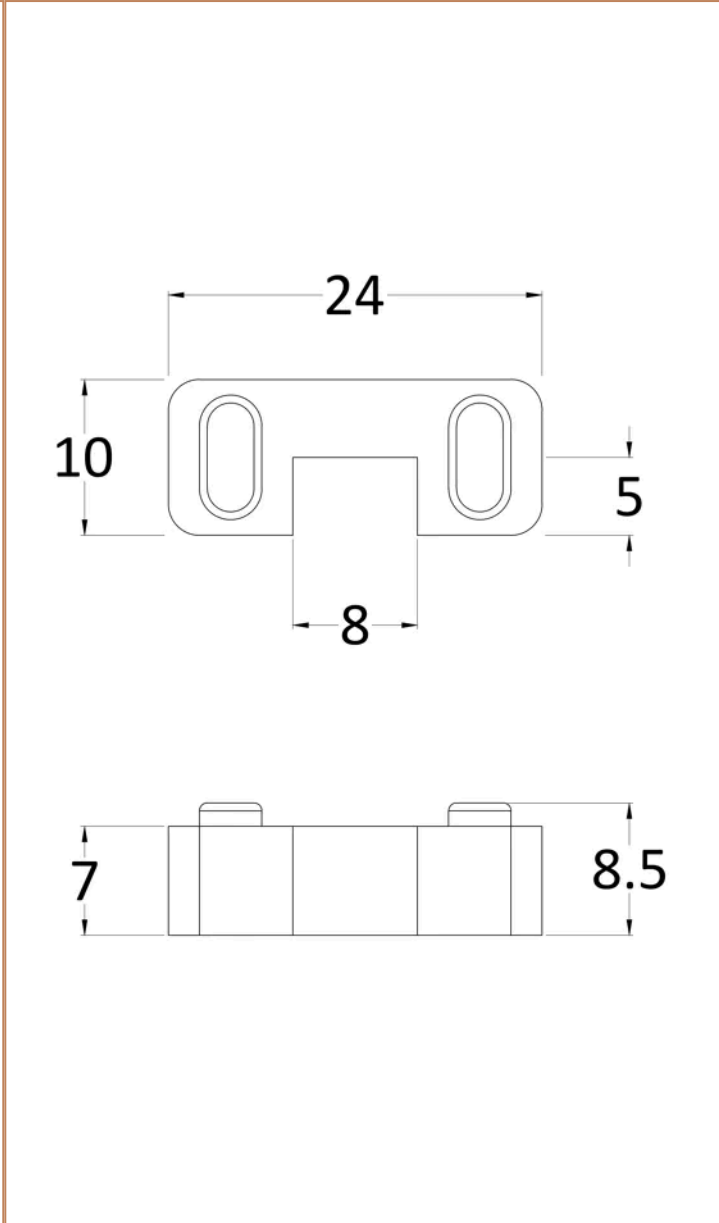

Product Dimensions

Product	10 x 24 x 9mm (H x W x D)
Packaged	45 x 30 x 44mm (H x W x D)
Nett Weight	0.16 kg
Packaged Weight	0.16 kg

Product Details

Country of Origin	United Kingdom
Product Material	Brass
Colour/Finish	Chrome
Style	Contemporary